



AUTORITÀ DI BACINO REGIONALE

PIANO DI BACINO STRALCIO SUL RISCHIO IDROGEOLOGICO

(ai sensi dell'art.1, comma 1, del D.L. 180/1998 convertito in L. 267/1998)

Caratteristiche idrauliche e geologiche del territorio

Valutazione del rischio idraulico e geomorfologico

VERIFICHE IDRAULICHE

Ambito di Bacino di rilievo regionale:

PORA

Bacino:

MAREMOLA

Comuni:

MAGLIOLO

PIETRA LIGURE

TOVO S. GIACOMO

GIUSTENICE

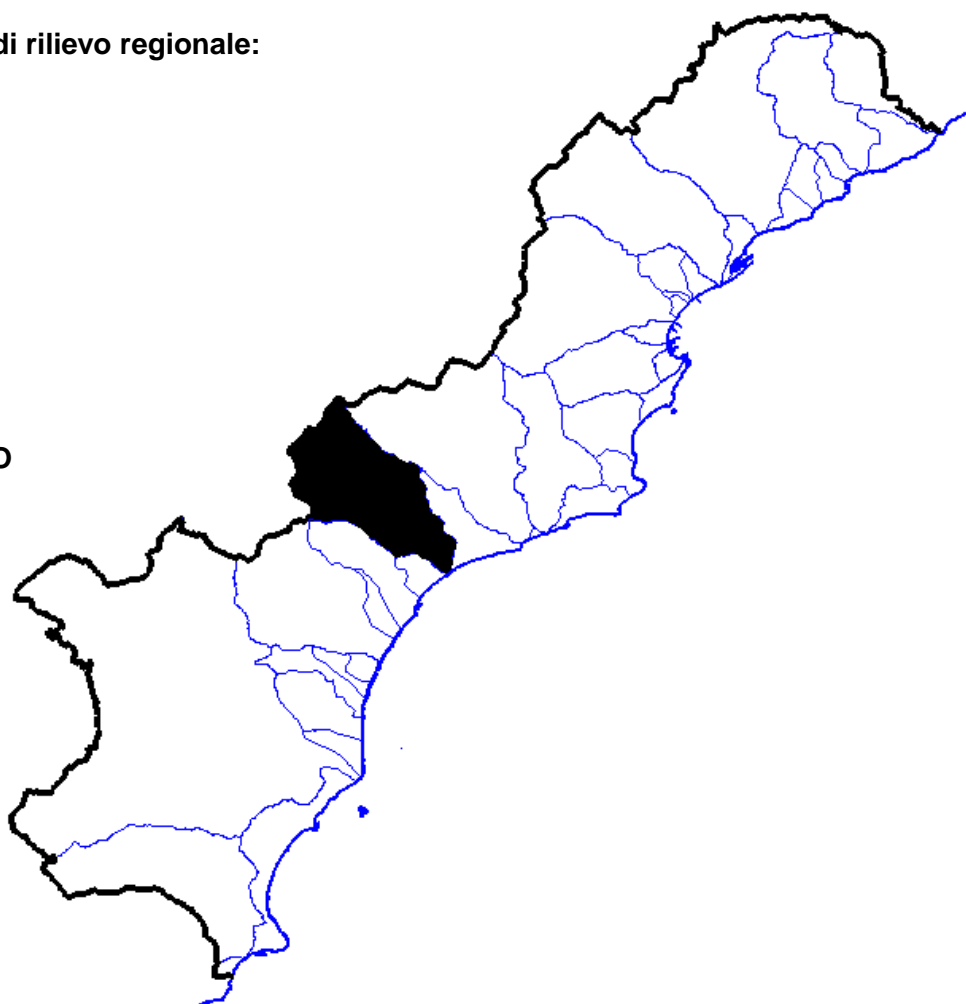

APPROVAZIONE	Delibera del Consiglio Provinciale di Savona n. 47 del 25/11/2003
ULTIMA MODIFICA	Decreto del Direttore Generale n. ... del
ENTRATA IN VIGORE	

INQUADRAMENTO

Nel corso del 2016 è pervenuto agli Uffici regionali, nell'ambito delle attività di aggiornamento del Piano degli Interventi del piano di bacino promosse dal Comune di Pietra Ligure, uno studio idraulico basato su un rilievo del corso d'acqua aggiornato alla primavera 2016. L'utilizzazione di questa nuova elaborazione ha consentito di definire le fasce di inondabilità del corso d'acqua a valle della confluenza con il Torrente Giustenice in modo più congruente con l'attuale stato dei luoghi.

Al fine di definire, attraverso un criterio prevalentemente topografico, l'estensione delle fasce di inondabilità per i diversi tempi di ritorno, è stato necessario calcolare il profilo di rigurgito della corrente nel tratto di corso d'acqua in esame. La porzione di torrente in esame si estende per circa 1300 metri ed è stata discretizzata in 50 sezioni trasversali al deflusso della corrente, con passo variabile, pari a circa 30 metri nei pressi della confluenza con il T. Giustenice, più ravvicinate in corrispondenza della foce e delle singolarità presenti (ponti, tombinature).

Utilizzando quali dati di input queste sezioni, per ciascuna delle quali sono state definite le grandezze geometriche (forma, dimensione), il valore delle portate come riportate nel vigente Piano di Bacino, e un valore del parametro di scabrezza K_s pari a $30 \text{ m}^{1/3} \text{ s}^{-1}$ (considerato, a favore di sicurezza applicabile sia all'alveo che alle sponde), mediante il codice di calcolo Hec ras, è stato definito il profilo di rigurgito della corrente nell'ipotesi di deflusso monodimensionale e moto permanente.

Sulla base delle verifiche idrauliche effettuate per le portate prescelte sono state individuate le aree perfluviali inondabili in caso di eventi di piena. Per il tracciamento delle linee che delimitano le aree inondabili con i diversi periodi di ritorno è stato utilizzato un procedimento di seguito schematizzato.

- 1) valutazione dei tratti e delle sezioni in cui il pelo libero ha quota superiore a quella delle sponde come da profilo di rigurgito, determinato tramite le verifiche idrauliche. Il software utilizzato, infatti, permette la visualizzazione contemporanea del livello di pelo libero e delle linee rappresentati le quote della sponda destra e sinistra, consentendo la distinzione di eventuali esondazioni su ciascuna delle due sponde. Data la necessaria schematizzazione nel tracciamento dei limiti di sponda, nel definire le fasce si è tenuto conto anche di quanto rilevato in occasione del sopralluogo effettuato in sito. La determinazione delle aree inondabili per un assegnato tempo di ritorno, cioè delle superfici sommerse dal relativo ipotetico evento di piena, è stata condotta sulla base dei criteri per l'elaborazione dei piani di bacino, suggeriti al punto 3 della Raccomandazione n°1 "Metodologia per la mappatura delle aree soggette a rischio di inondazione" (1995) dall'Autorità di Bacino di rilievo regionale della Regione Liguria. Sono stati, inoltre, individuati i tratti critici del corso d'acqua (in corrispondenza di ponti, tombinature, coperture, ecc.) procedendo alla loro verifica con i franchi di sicurezza di legge;
- 2) tracciamento delle linee indicative delle aree inondabili, definite come involuppo dei punti di intersezione fra la quota idrometrica determinata per le diverse portate di riferimento e la

topografia del terreno o le opere spondali esistenti. Qualora in corrispondenza delle linee stesse si trovassero discontinuità, tipicamente rappresentate da edifici inframmezzati da varchi quali cancelli o accessi a raso, si è considerato il defluire delle acque attraverso essi, con la conseguente inondabilità delle aree limitrofe;

- 3) verifica, tramite sopralluogo, della congruenza tra le linee tracciate e la morfologia dei luoghi, con particolare riguardo ai tratti di corso d'acqua con opere antropiche interferenti con il deflusso della corrente.

Di seguito vengono riportati i profili della corrente, le verifiche idrauliche e le tabelle con le principali grandezze relativi al Torrente Maremola (distinto nelle parti di monte e di valle), al suo affluente T. Giustenice (indicato nel presente Piano anche come T. Scarincio) e ai vari Rii minori scolanti in questi due corsi d'acqua.

AVVERTENZA

NELLA CARTA DELLE AREE INONDABILI, LE SEZIONI DEI RII MAREMOLA, GIUSTENICE (SCARINCIO) E RII MINORI CHE RIPORTANO ACCANTO AL NOME UNA LABEL (I.E. SAN LORENZO, FERRIERA, TOVO, ETC...) DISCENDONO DA MODELLAZIONI IDRAULICHE RISALENTI ALLA PRIMA REDAZIONE DEL PRESENTE PIANO (APPROVATO CON DCP N.47 DEL 25.11.2003).

POICHÉ QUESTI TRATTI DEI RII NON SONO STATI INTERESSATI DA NUOVI STUDI IDRAULICI SOPRAVVENUTI NEGLI ANNI, LE SEZIONI IN ESSI RICADENTI SONO STATE MANTENUTE CON LA NUMERAZIONE ORIGINALE, CUI SI È ACCOMPAGNATA UNA ETICHETTA PER RENDERLE IMMEDIATAMENTE IDENTIFICABILI.

PER QUANTO CONCERNE IL RIO GALANO, SI RIMANDA ALLA RELAZIONE GENERALE PER LA DESCRIZIONE DELLE DUE VERIFICHE PUNTUALI EFFETTUATE IN SEDE DI PRIMA STESURA DEL PIANO (ANNO 2003).

T. MAREMOLA – tratto di valle

dalla SEZ. **50** (confluenza con T. Giustenice)
alla SEZ. **1** (foce)

- PROFILI DI RIGURGITO IN CONDIZIONI DI MOTO PERMANENTE PER LE PORTATE T=50, 200, 500 ANNI

- GEOMETRIA DELLE SEZIONI ED ALTEZZA DEL PELO LIBERO IN CONDIZIONI DI MOTO PERMANENTE PER LE PORTATE T=50, 200, 500 ANNI

- MODELLAZIONE IDRAULICA IN CONDIZIONI DI MOTO PERMANENTE:
TABELLE DELLE GRANDEZZE IDRAULICHE
SIGNIFICATIVE PER LE PORTATE T=50, 200, 500 ANNI

Torrente Maremola e Rio Giustenice Plan: _settembre_2017_portate

Maremola Foce

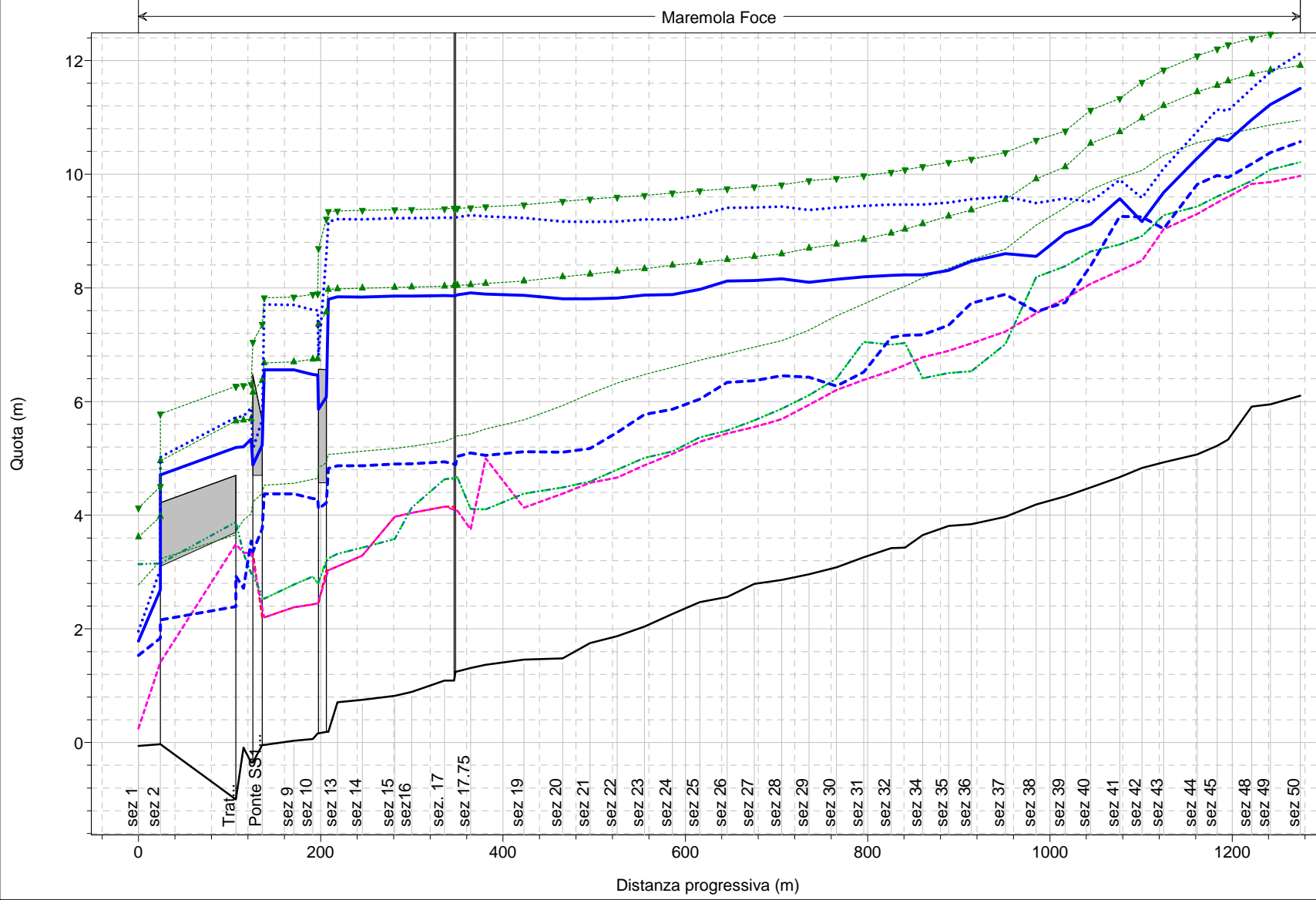

Quota (m)

Distanza progressiva (m)

Legend	
EG T=500	(Dotted green line with triangles)
EG T=200	(Dotted green line with triangles)
EG T=50	(Dotted blue line with triangles)
PL T=500	(Solid blue line)
PL T=200	(Solid blue line)
PL T=50	(Dashed blue line)
Fondo	(Solid black line)
Sponda SX	(Dashed green line)
Sponda DX	(Dashed green line)
Argine SX	(Dashed pink line)
Argine DX	(Dashed pink line)

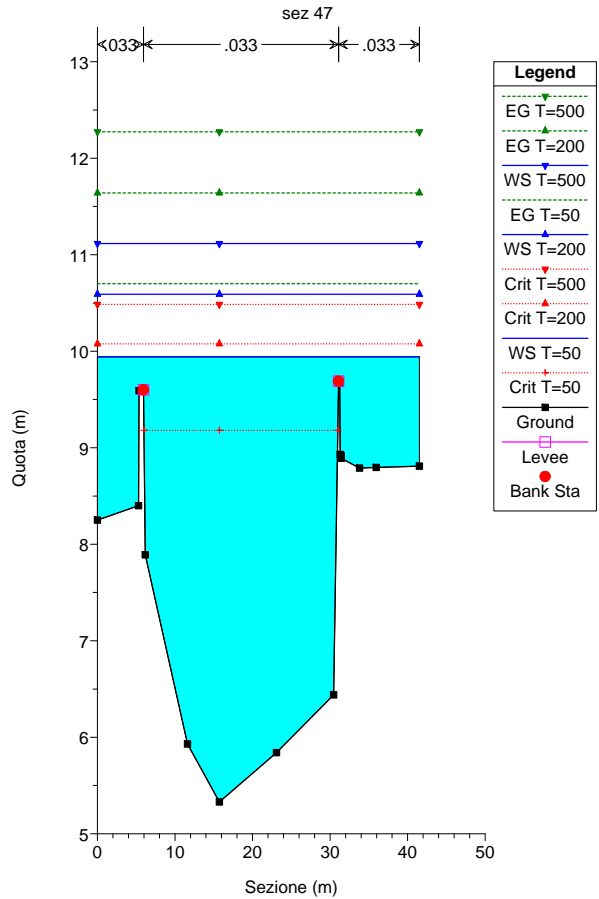
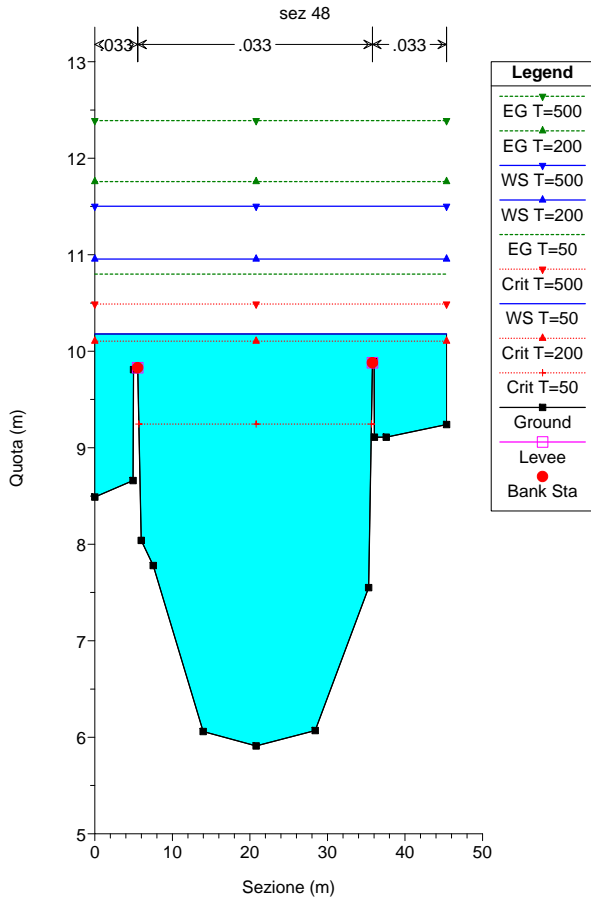
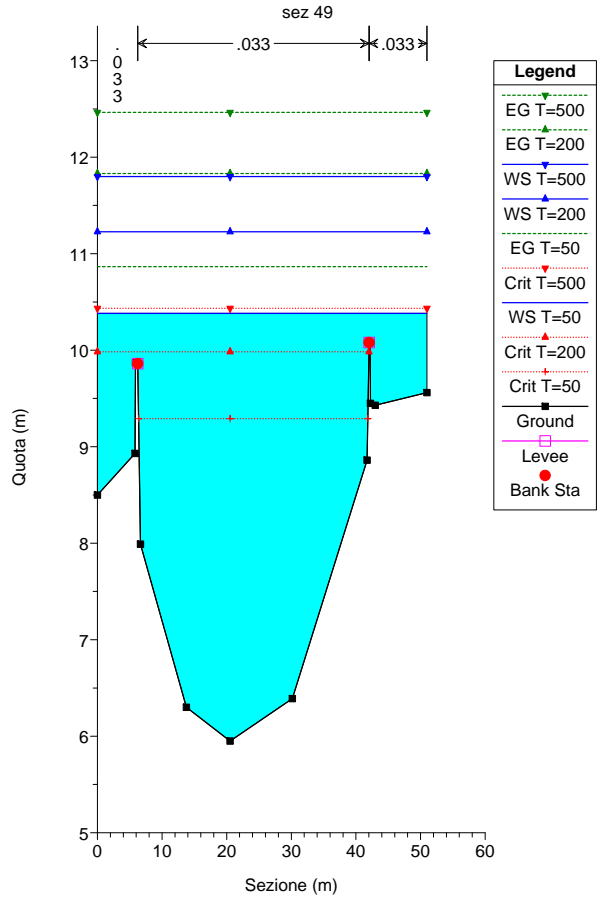
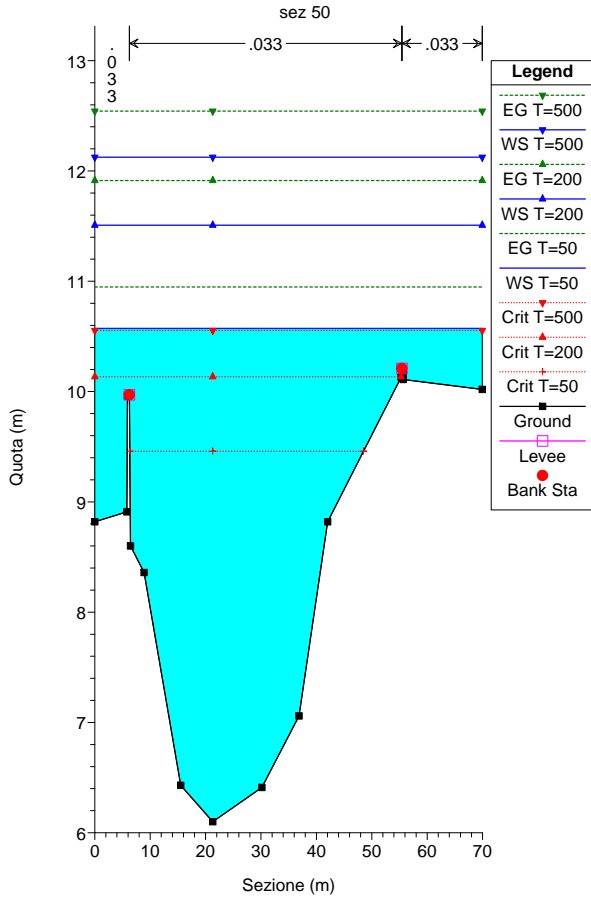

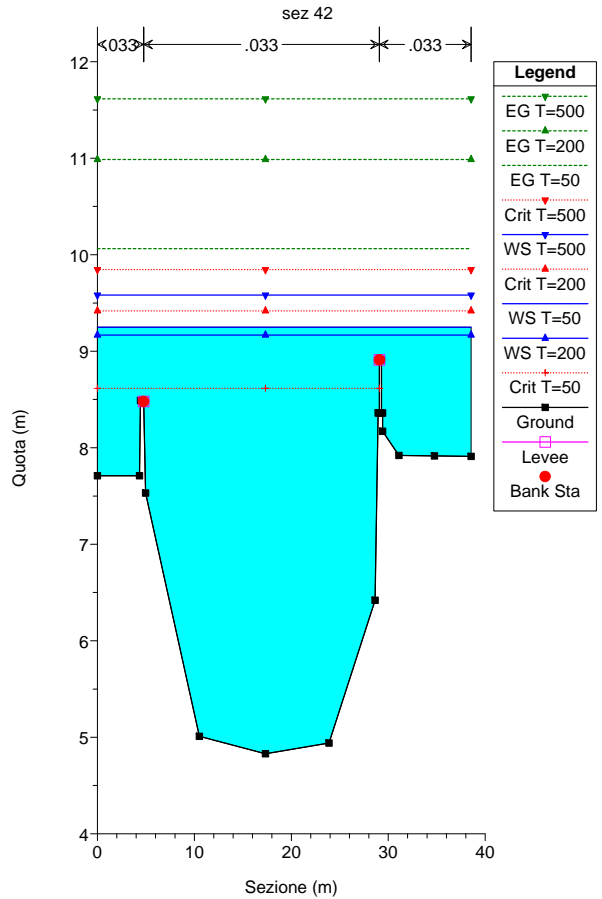
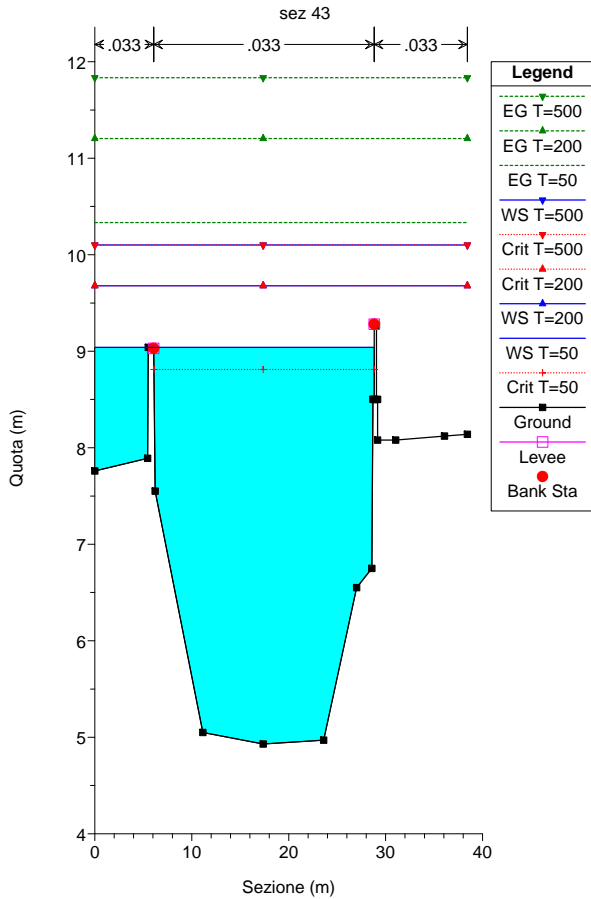
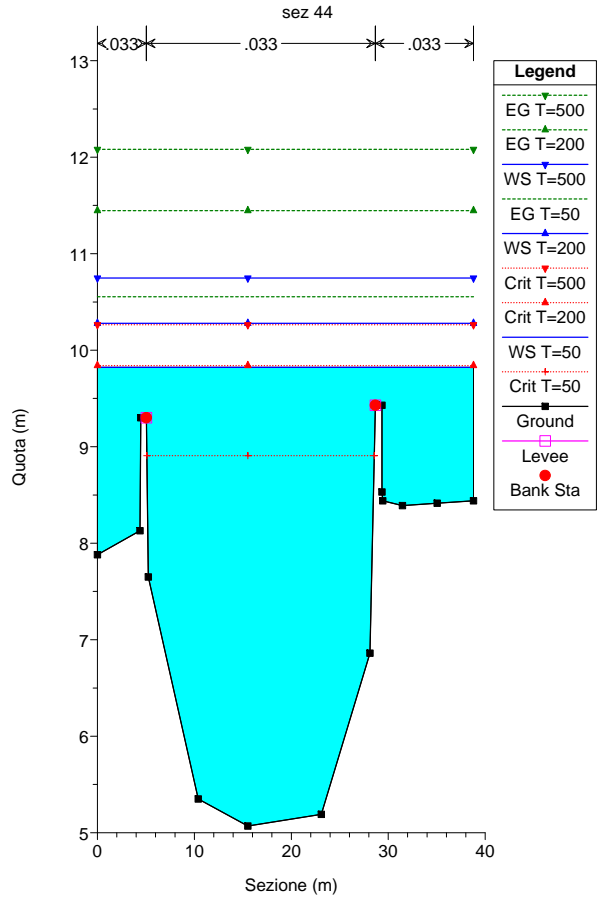
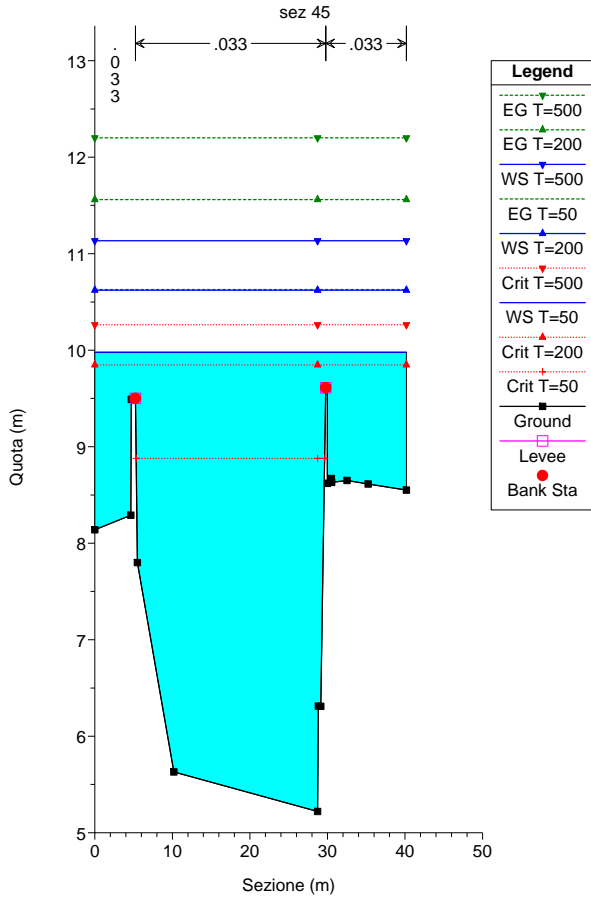

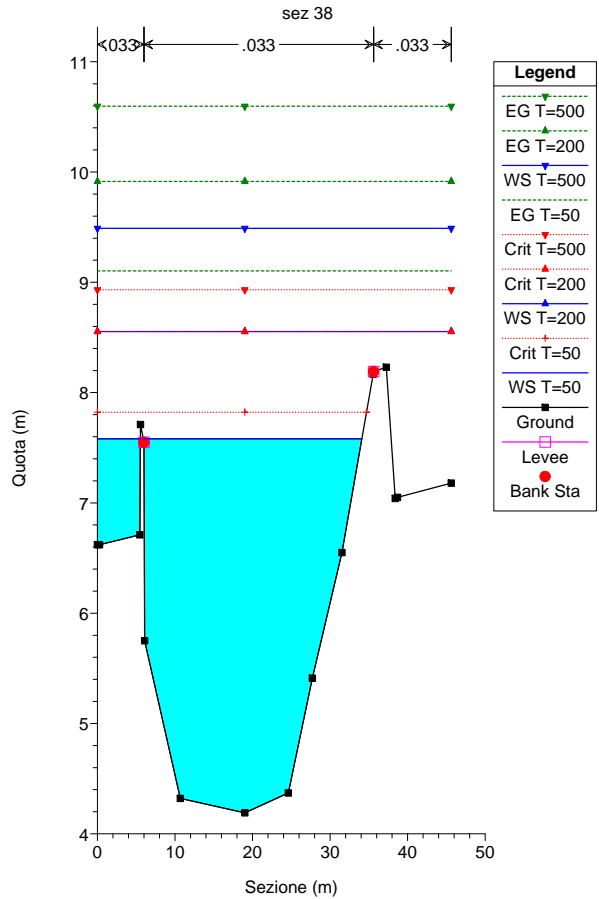
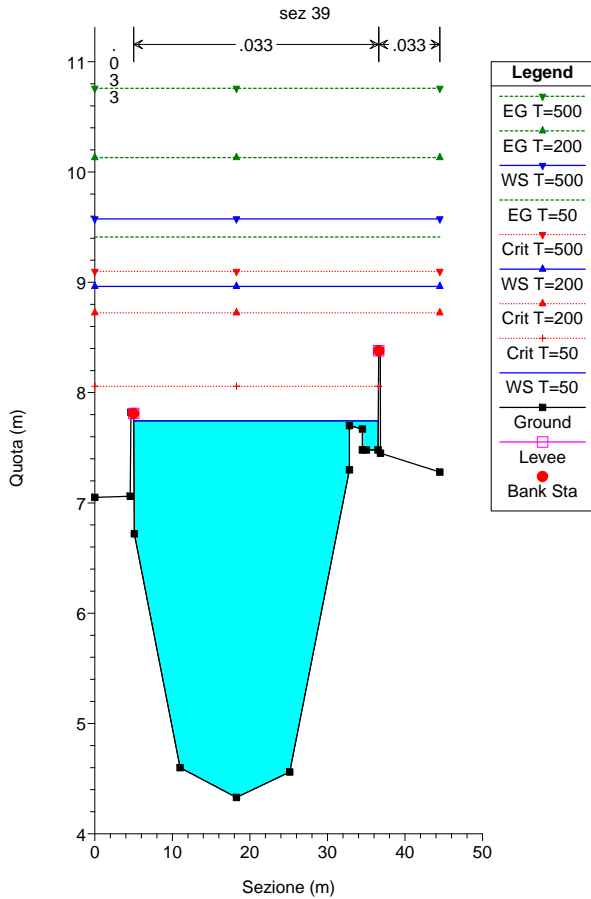
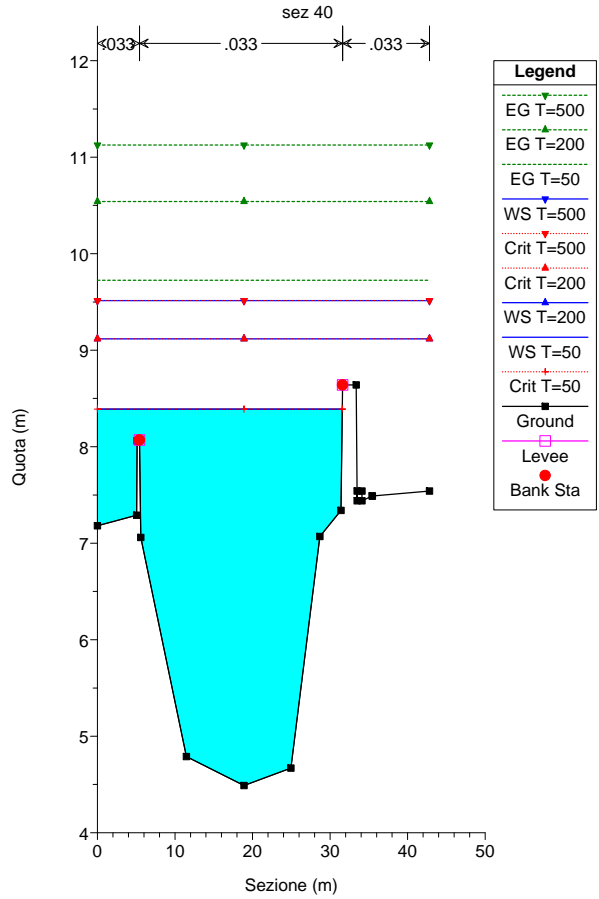
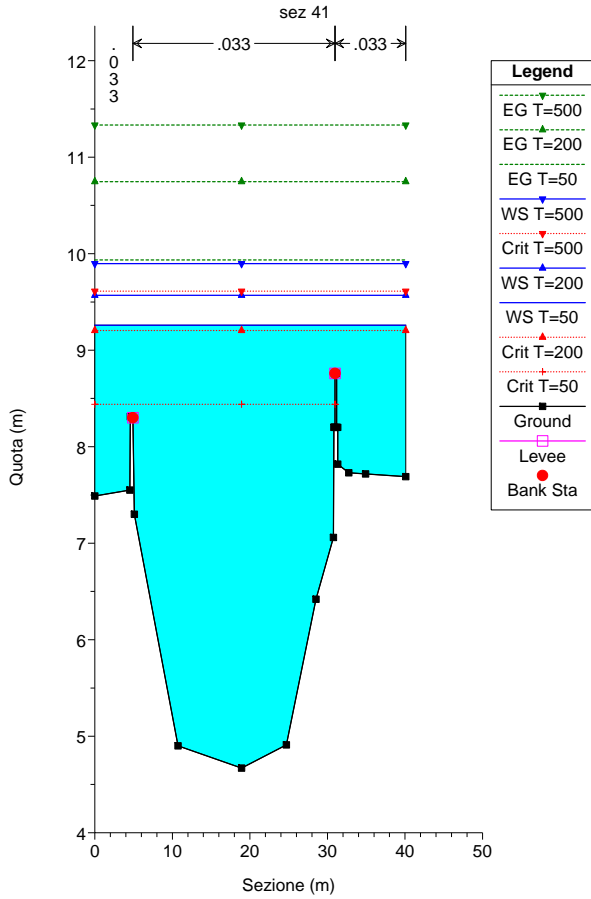

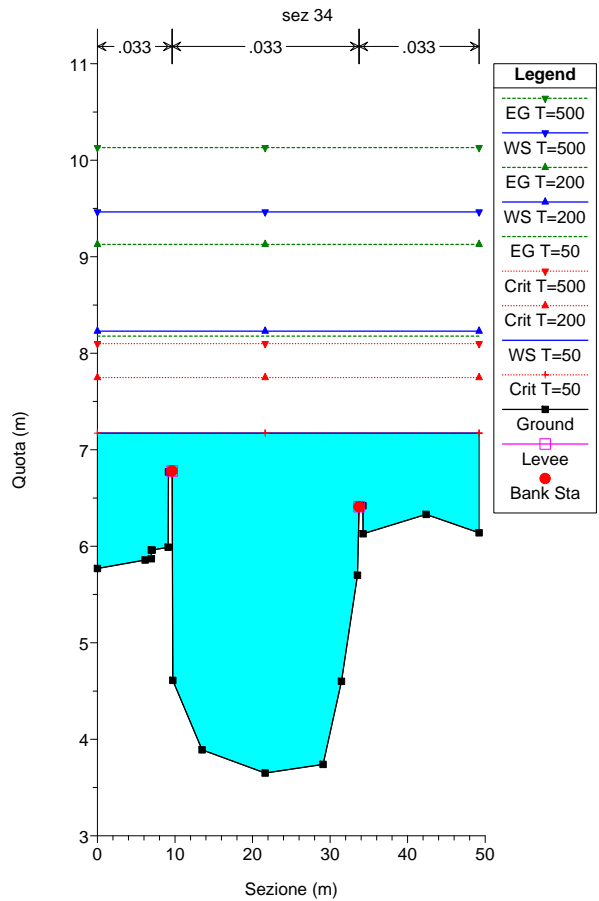
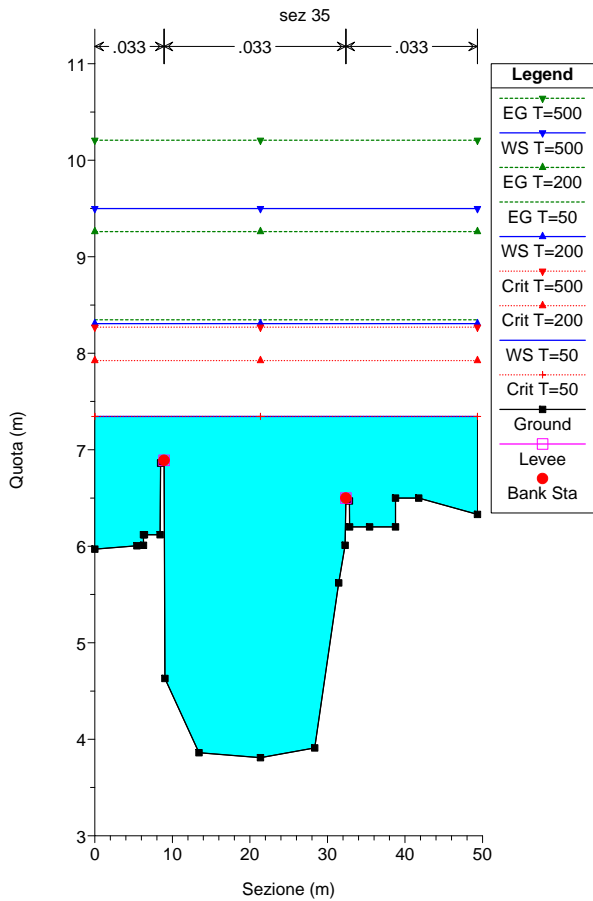
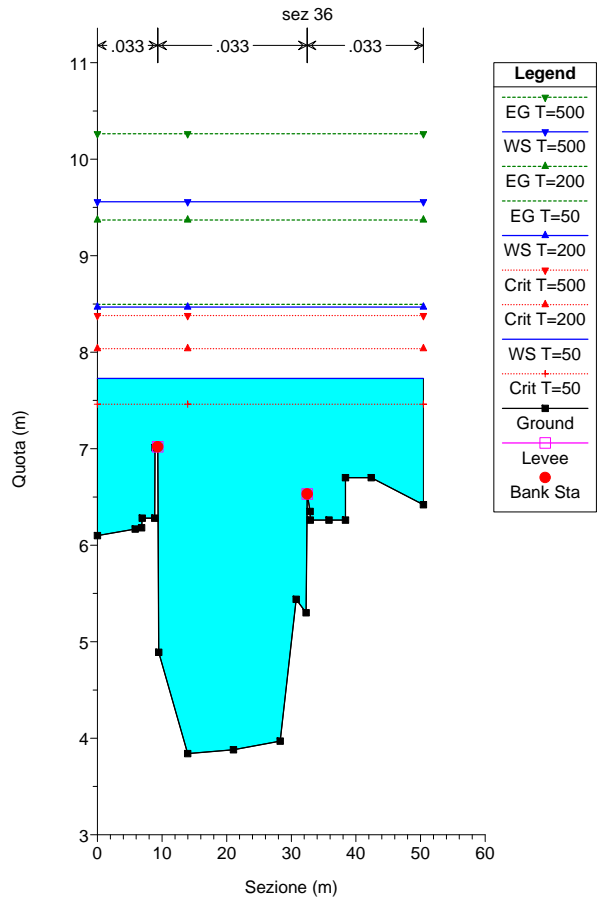
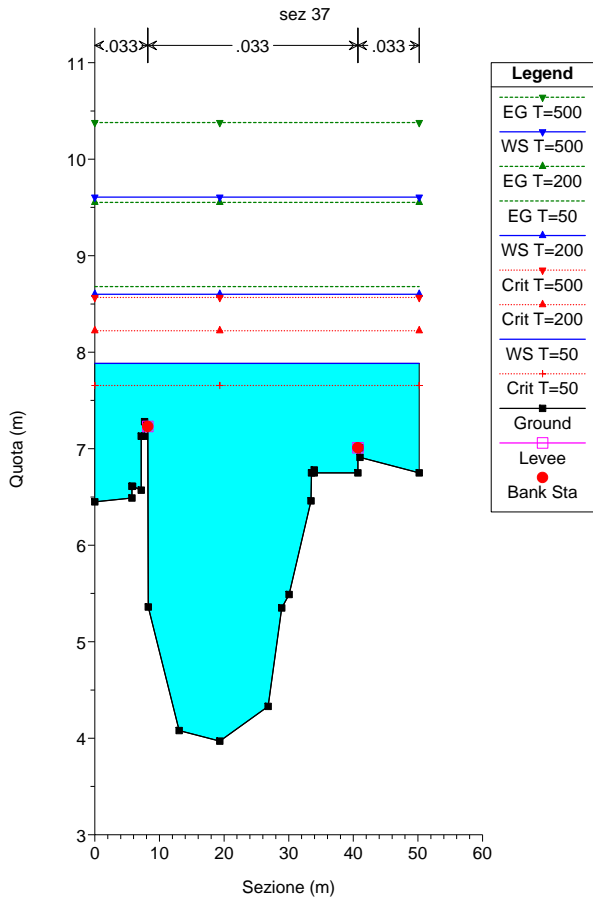

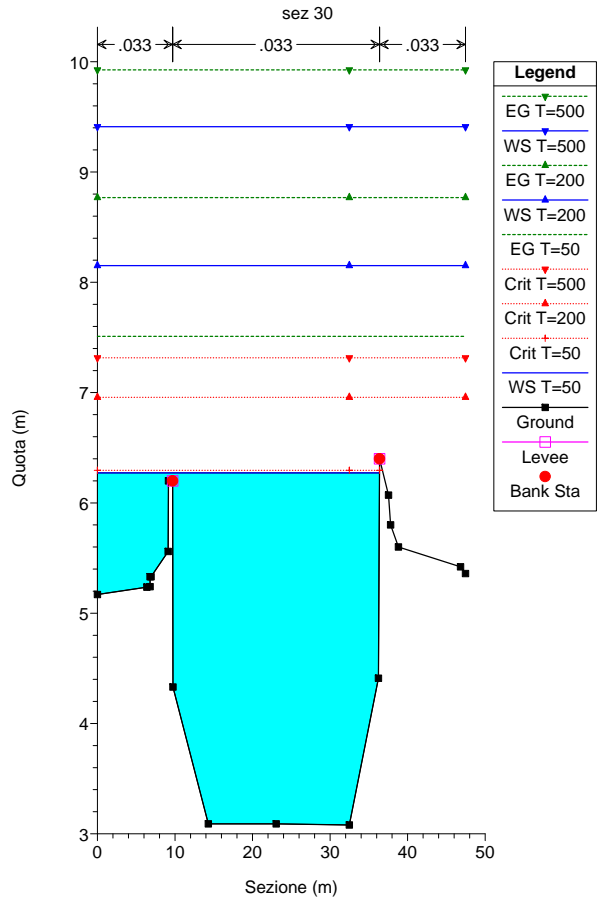
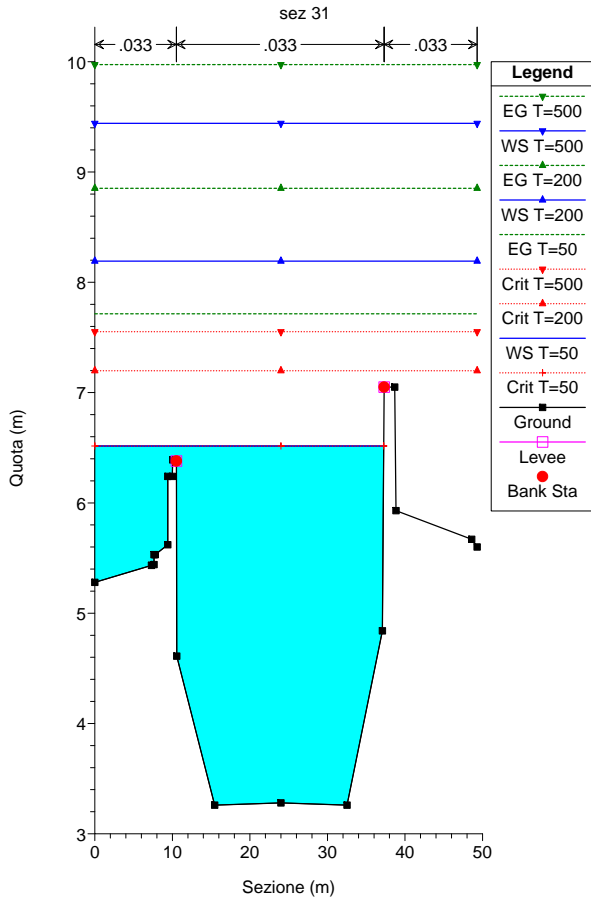
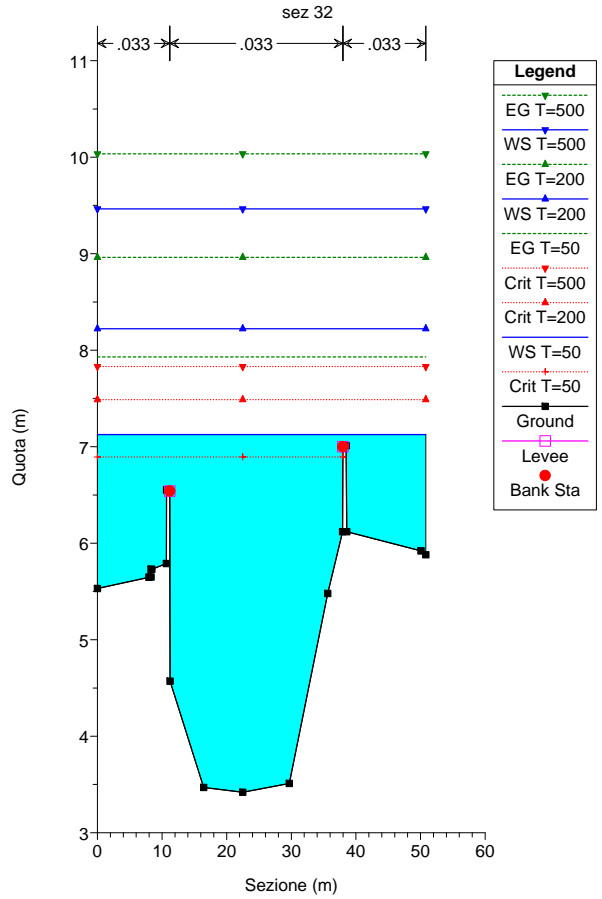
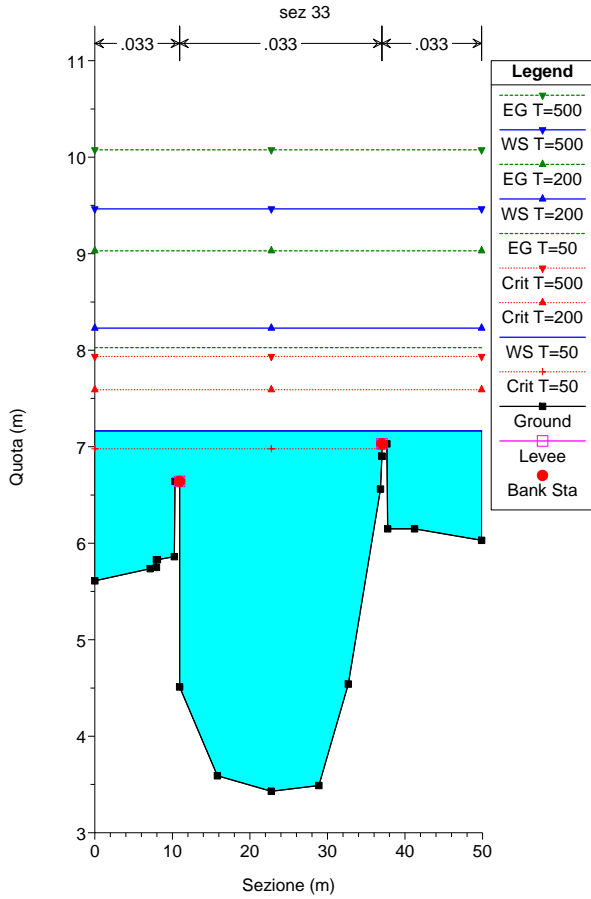

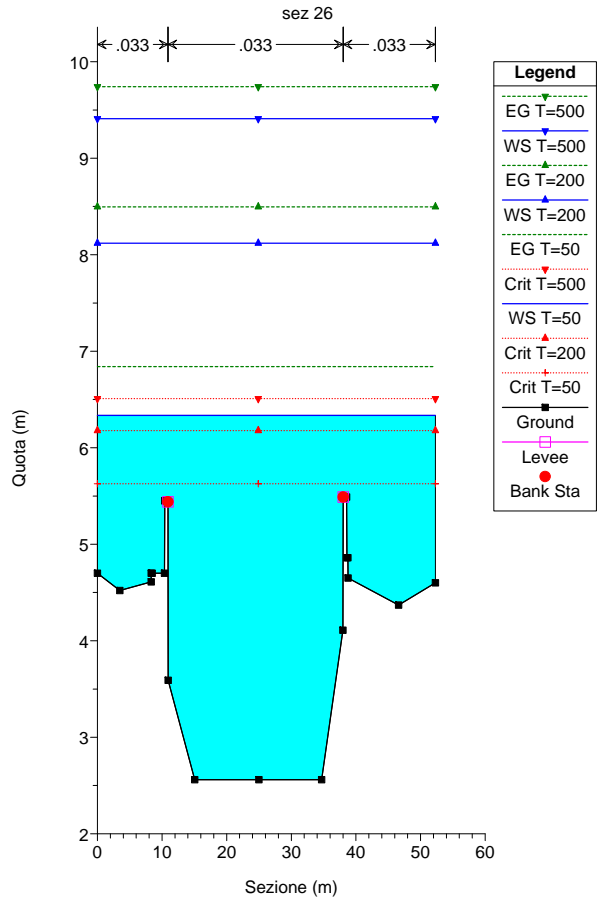
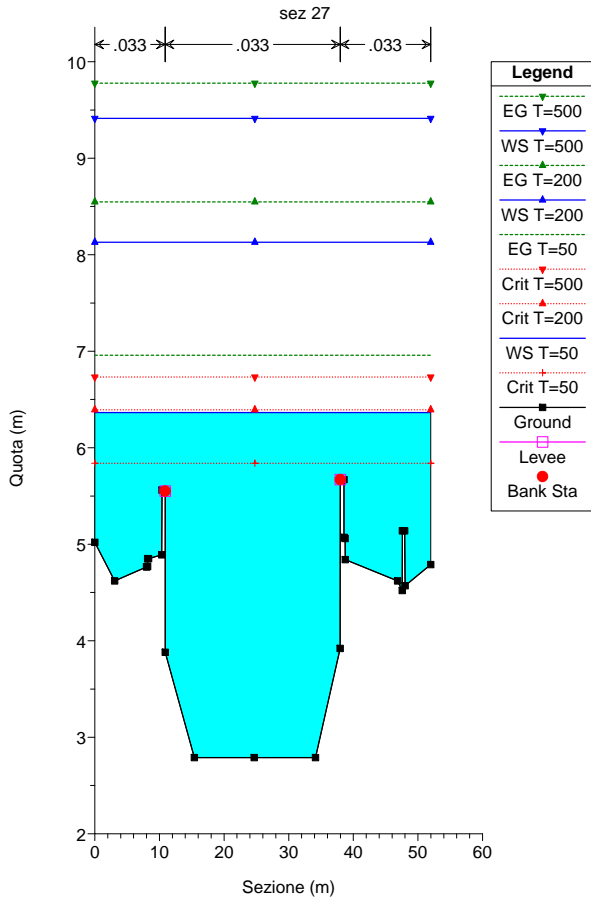
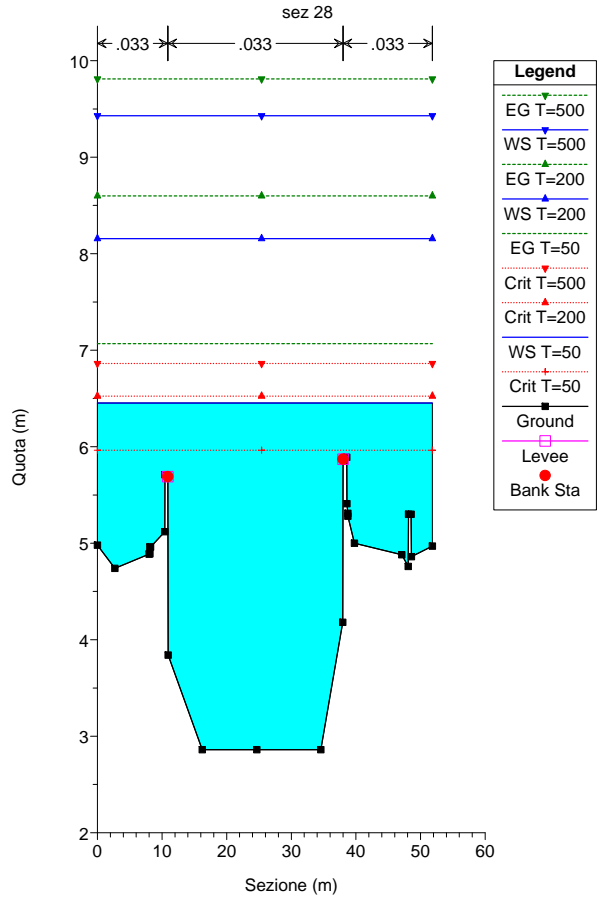
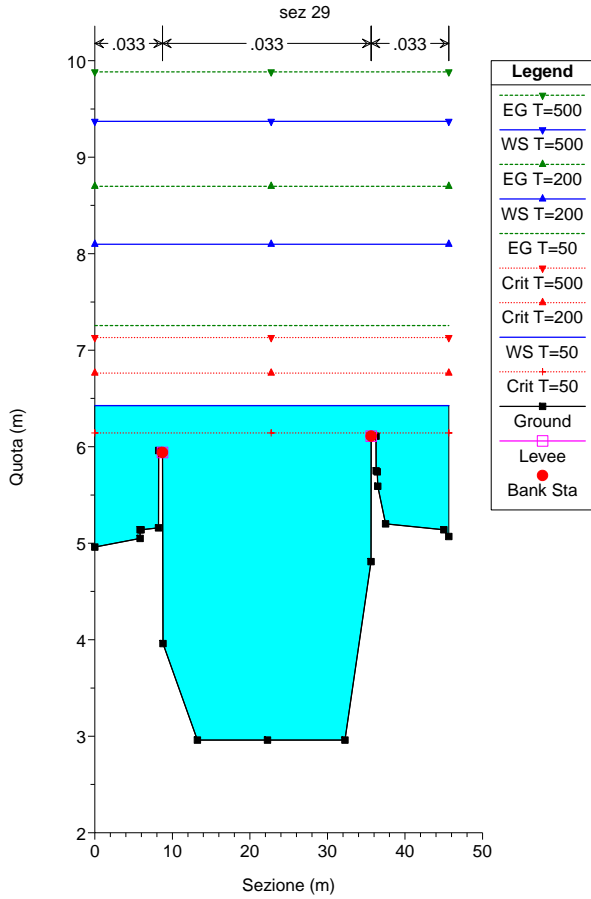

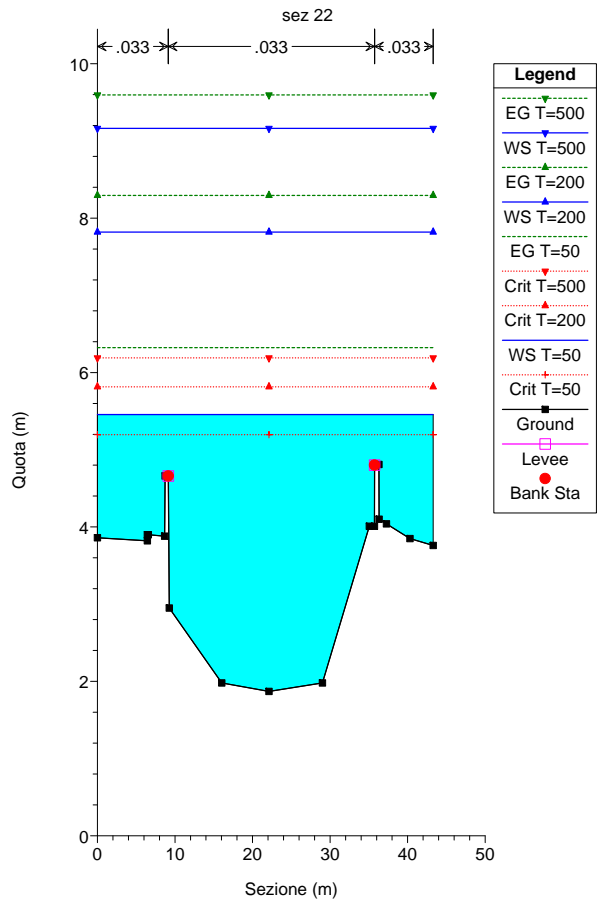
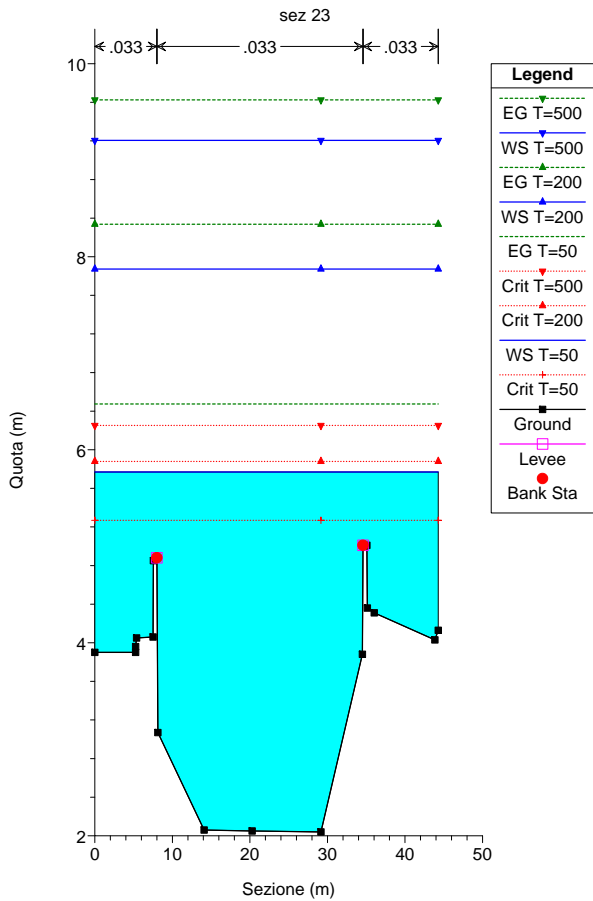
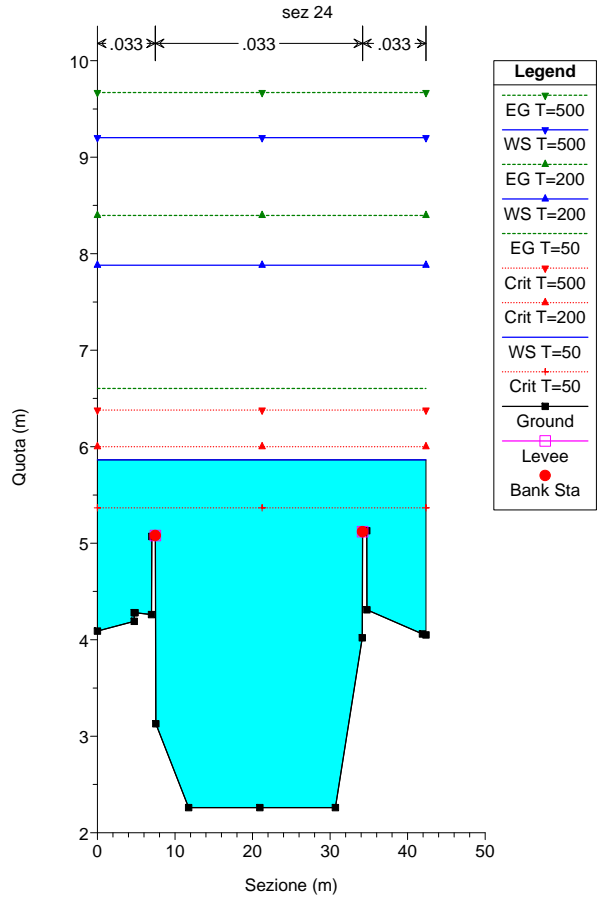
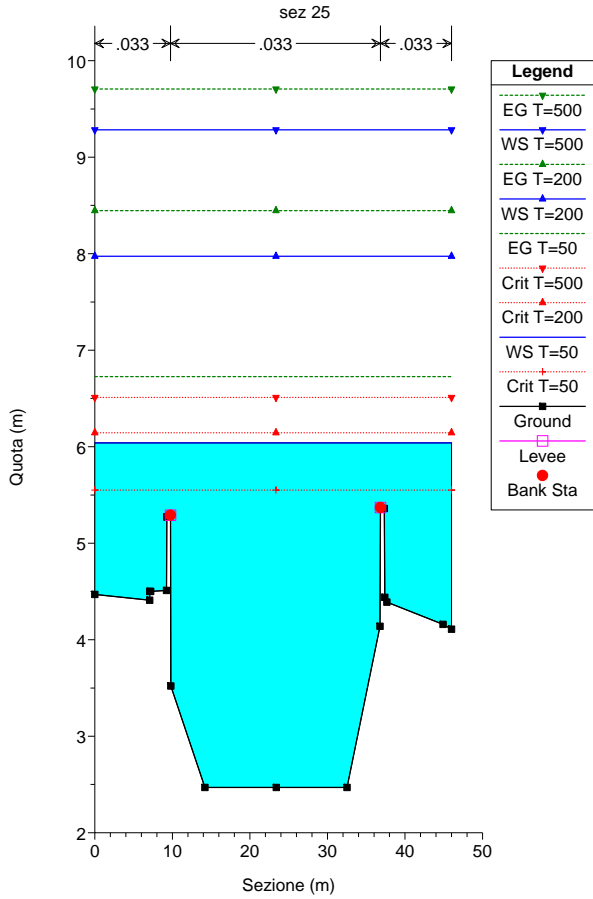

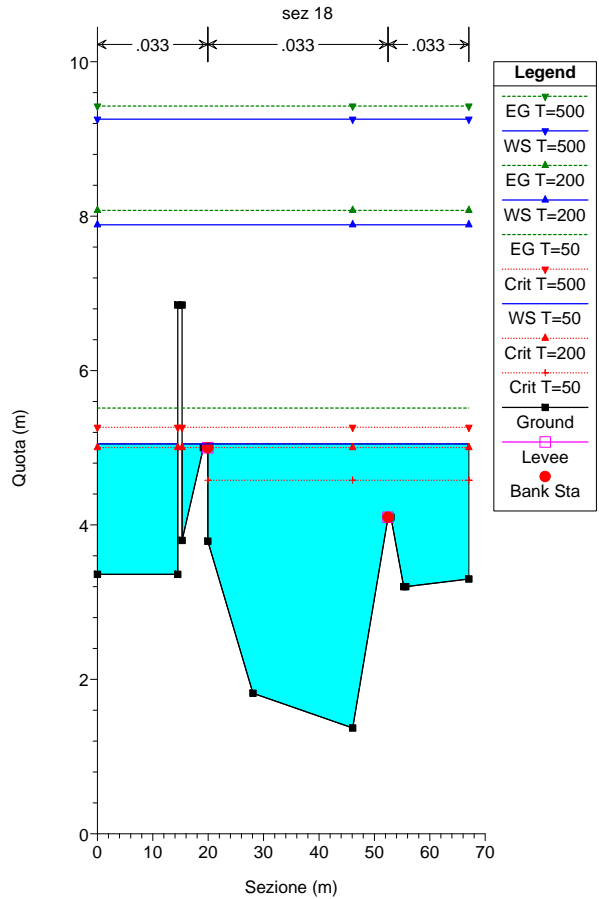
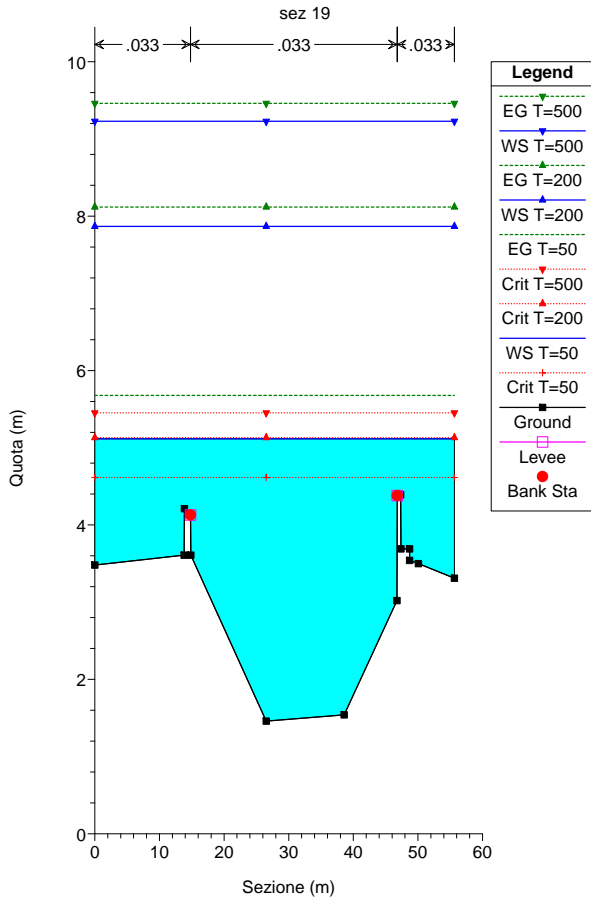
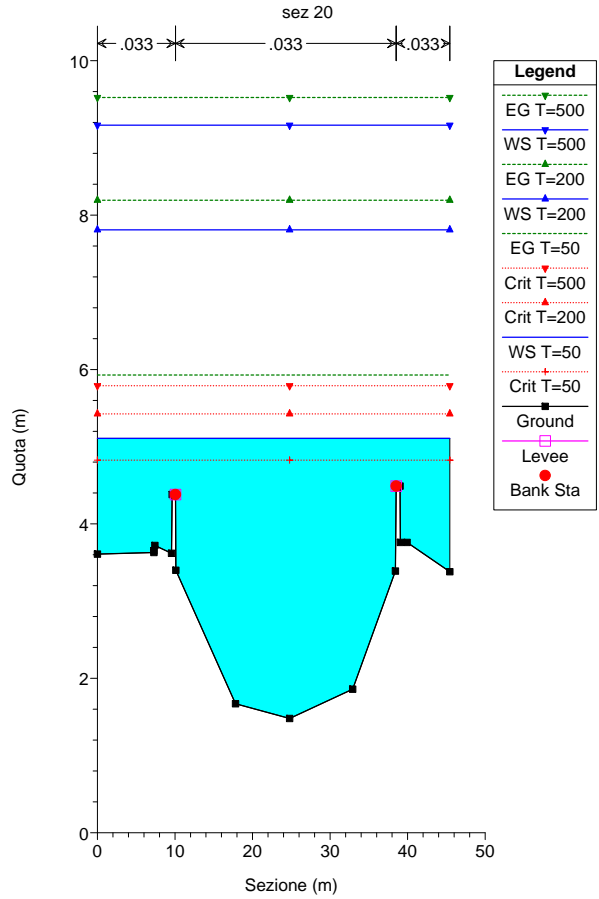
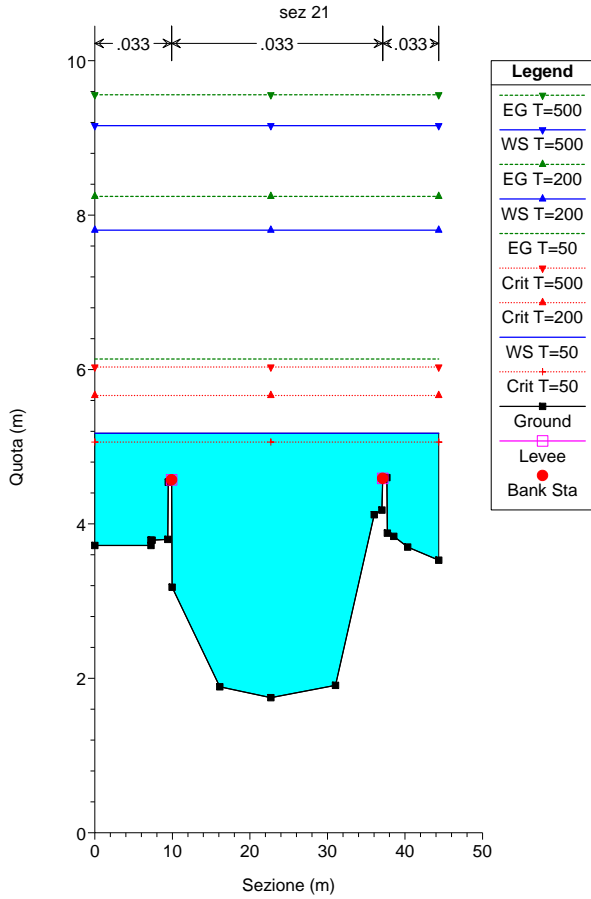

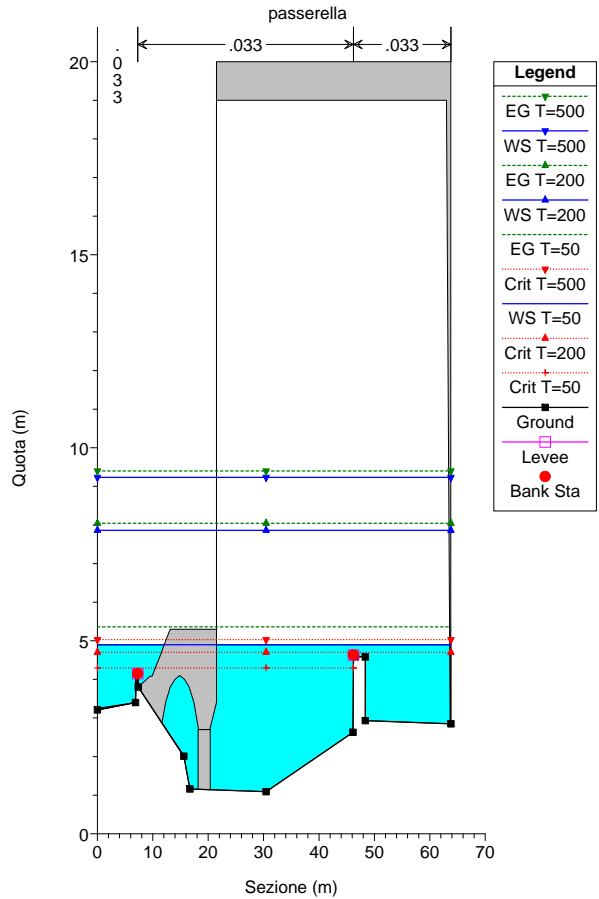
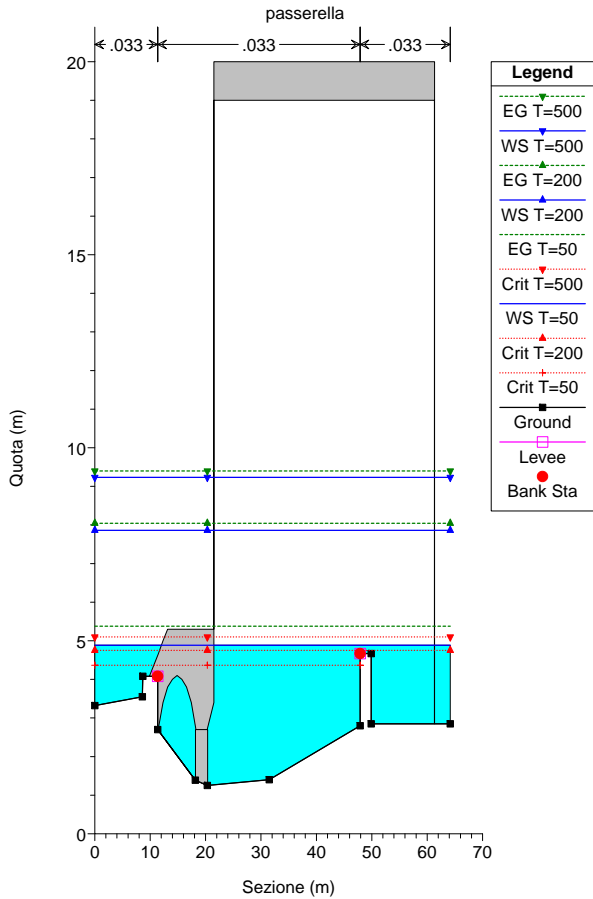
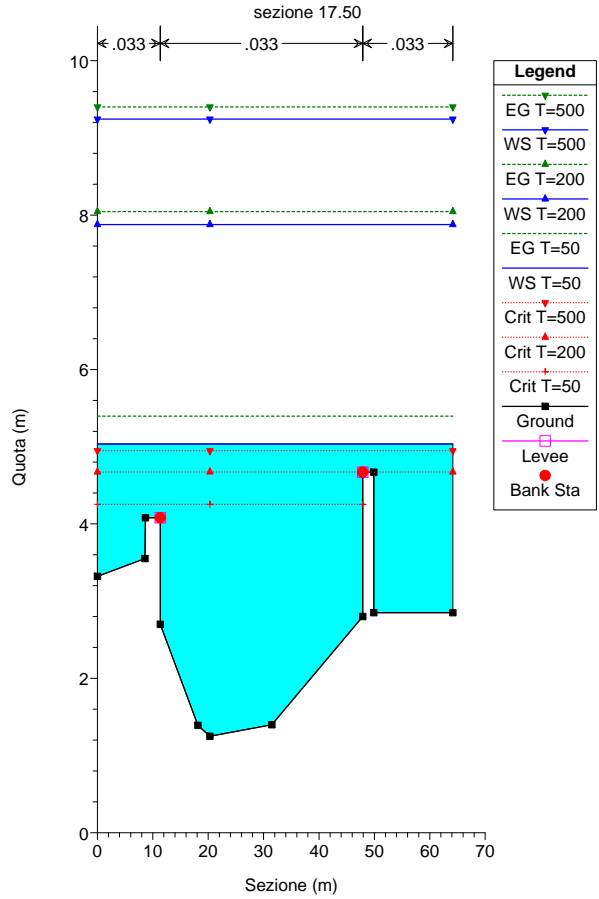
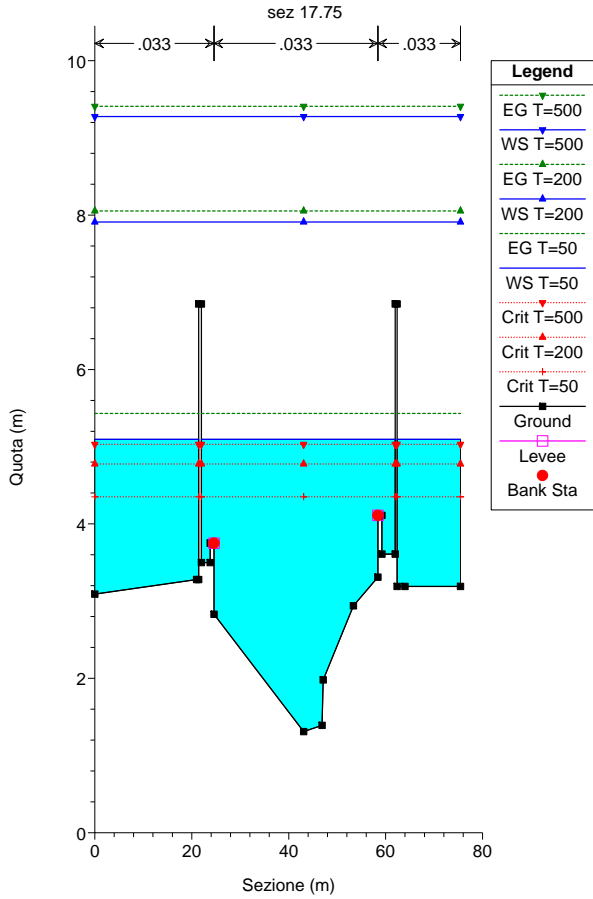

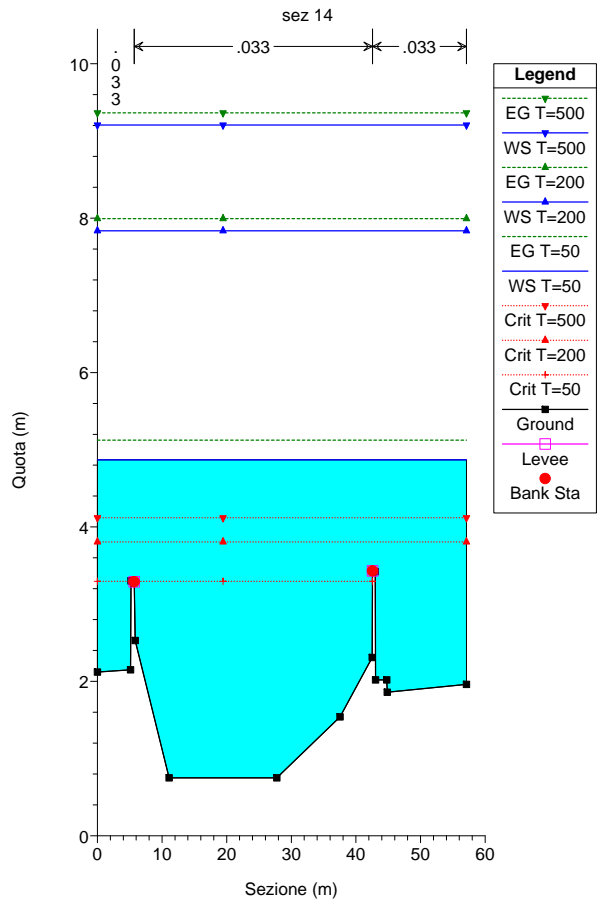
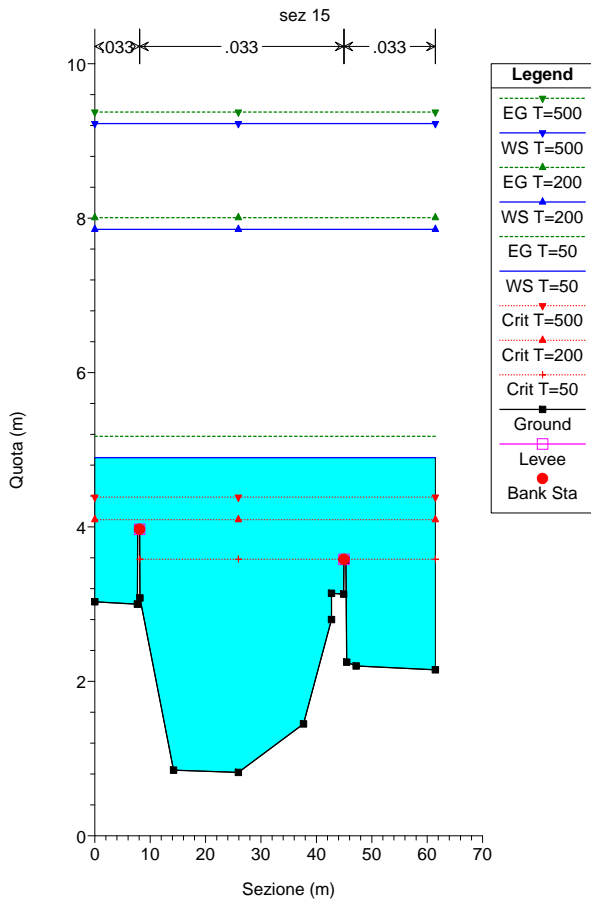
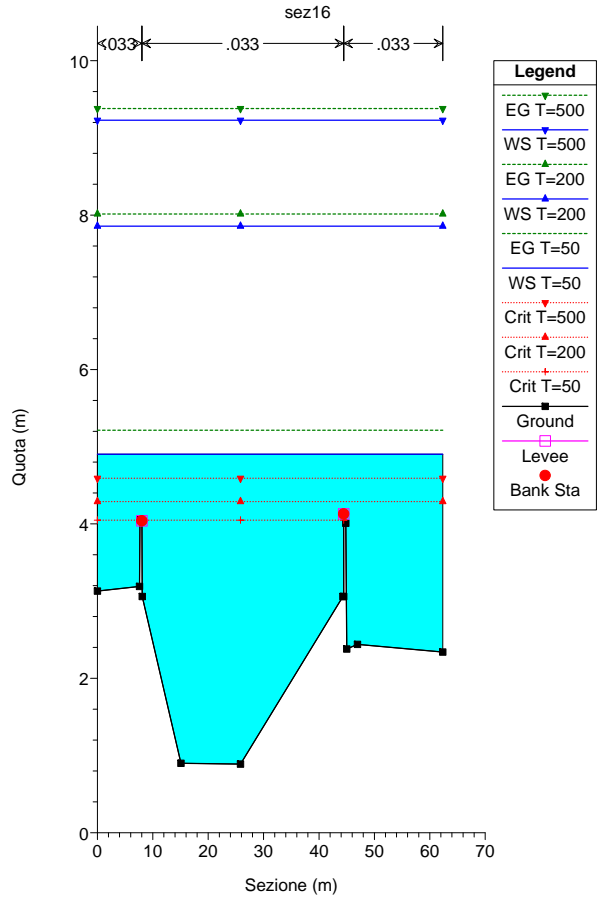
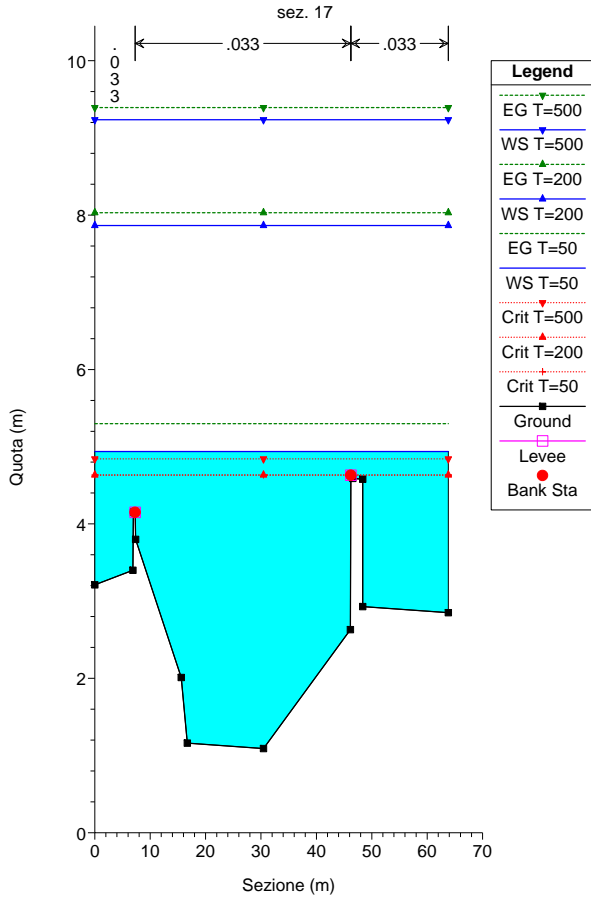

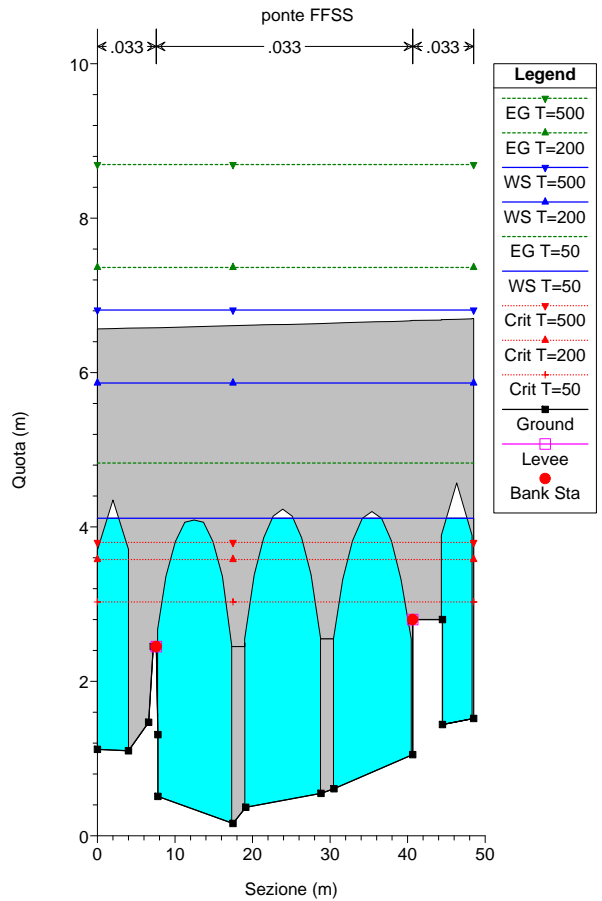
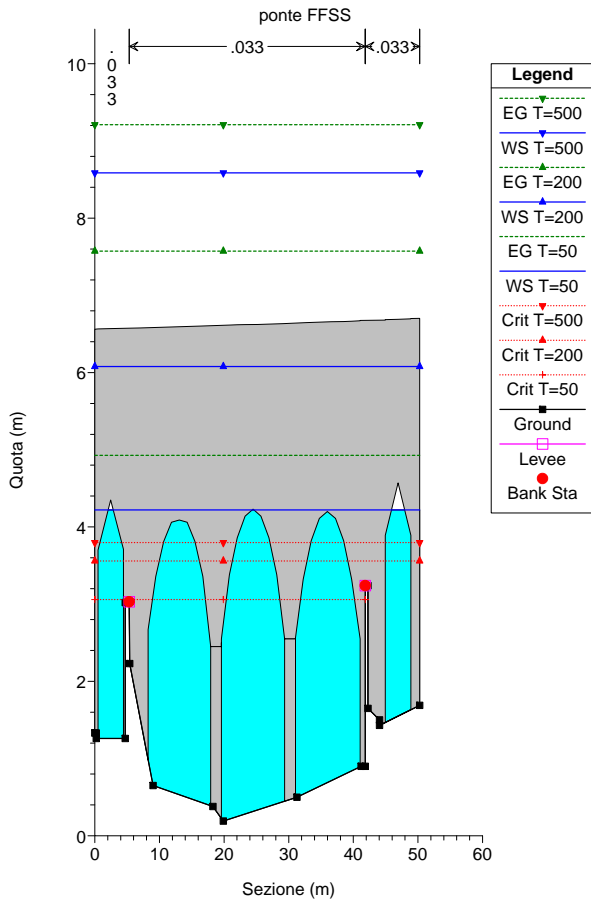
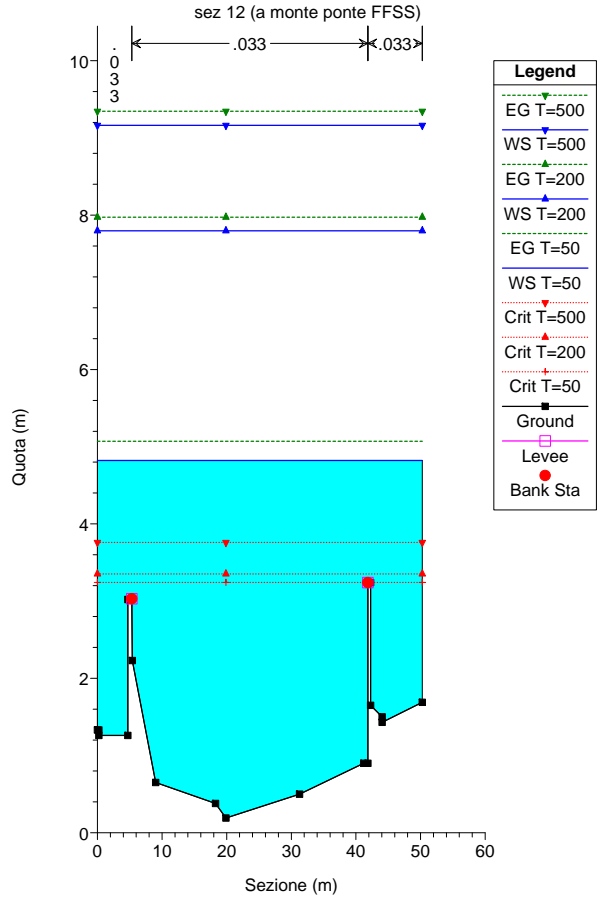
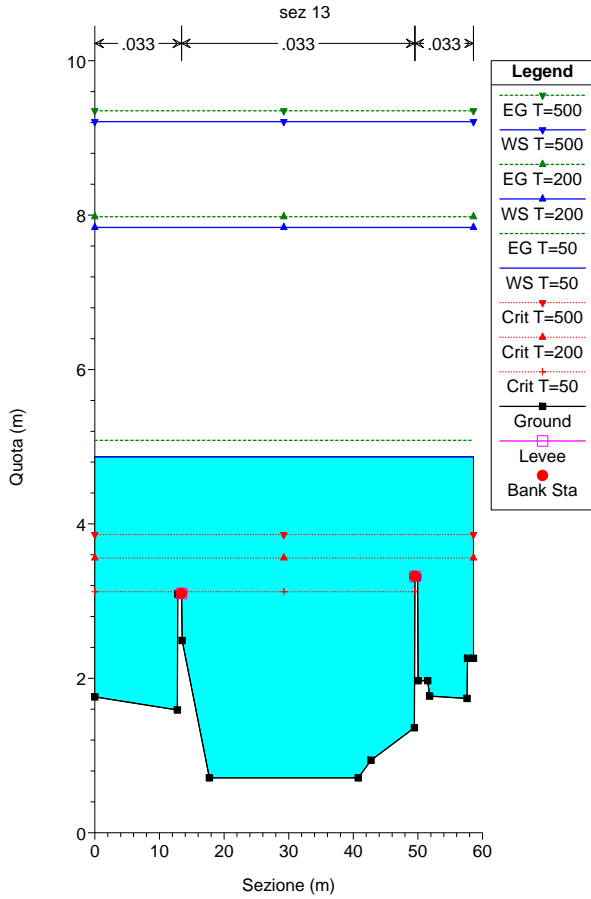

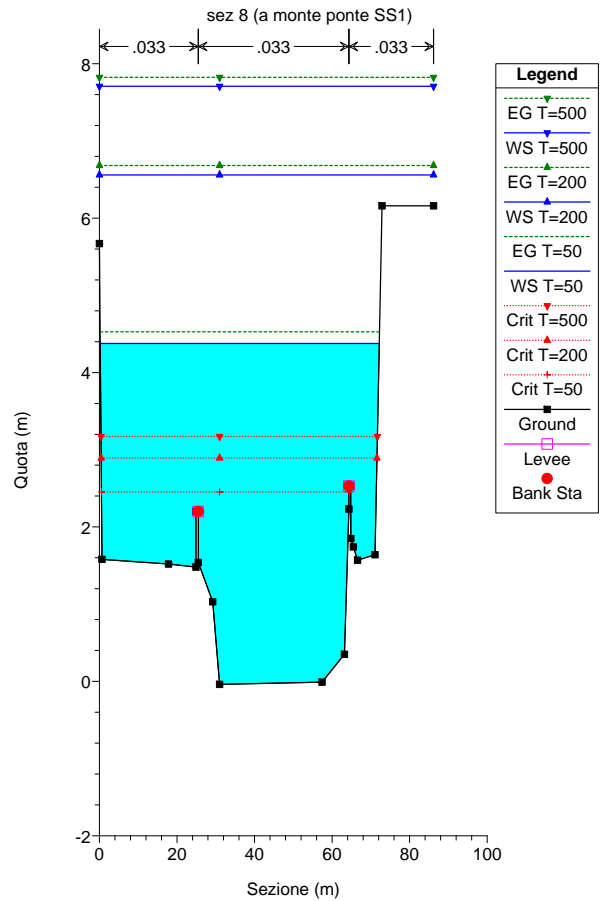
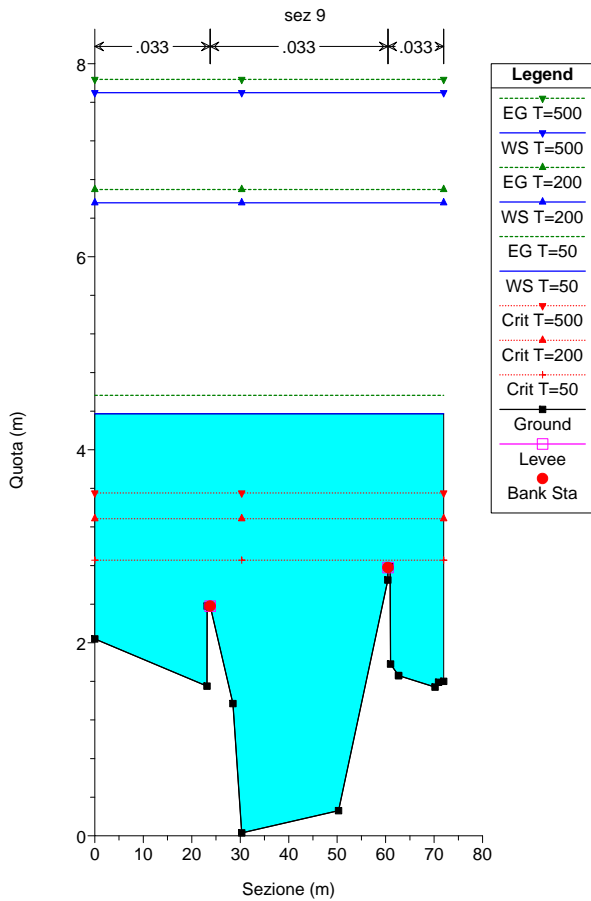
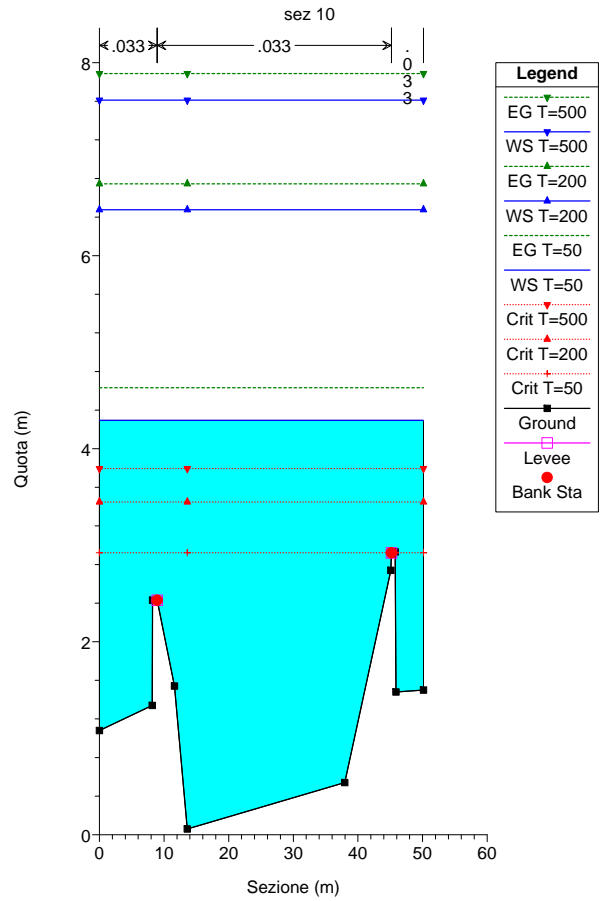
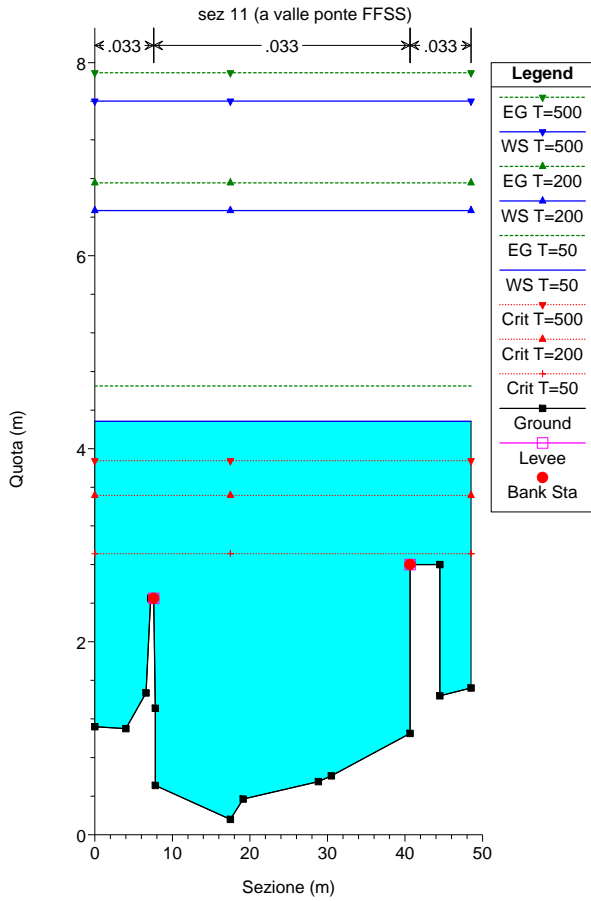

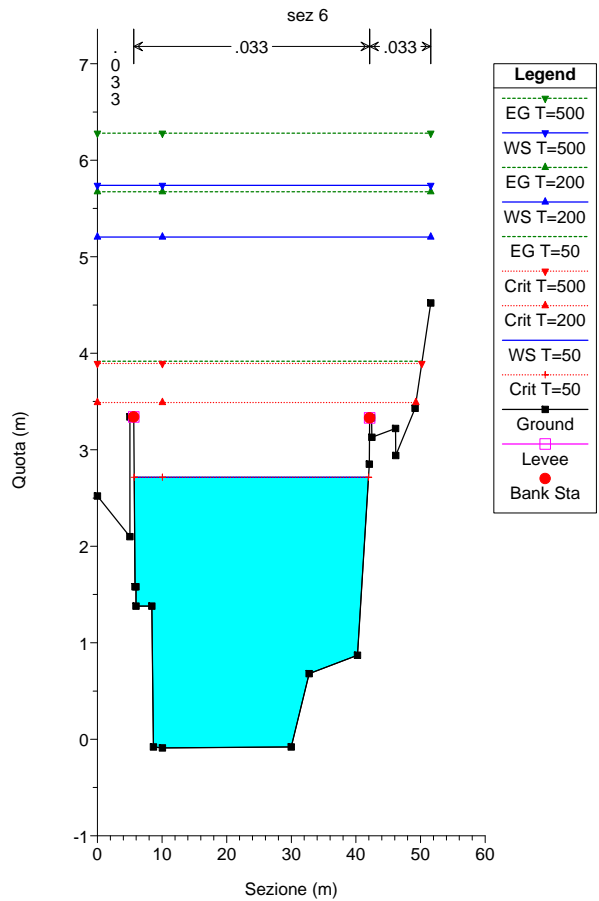
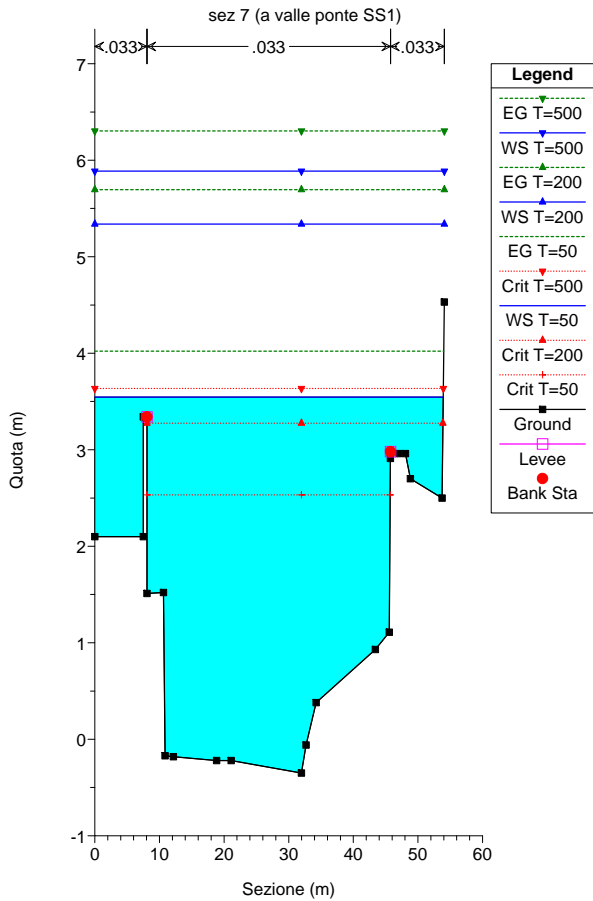
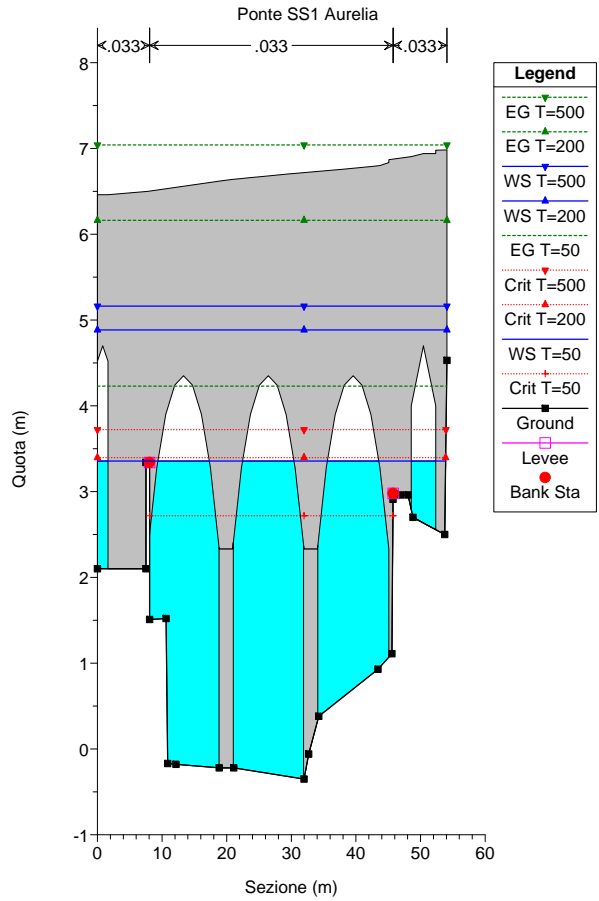
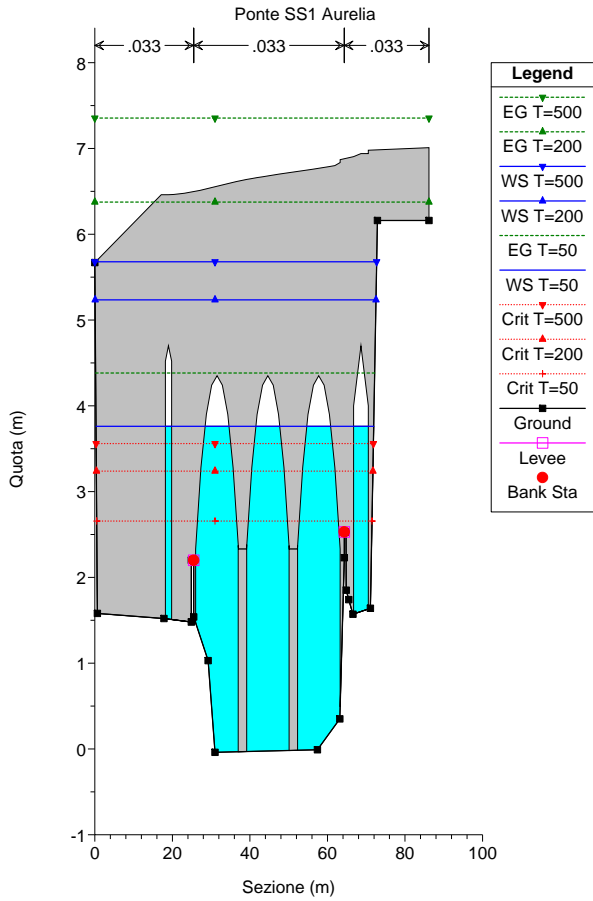

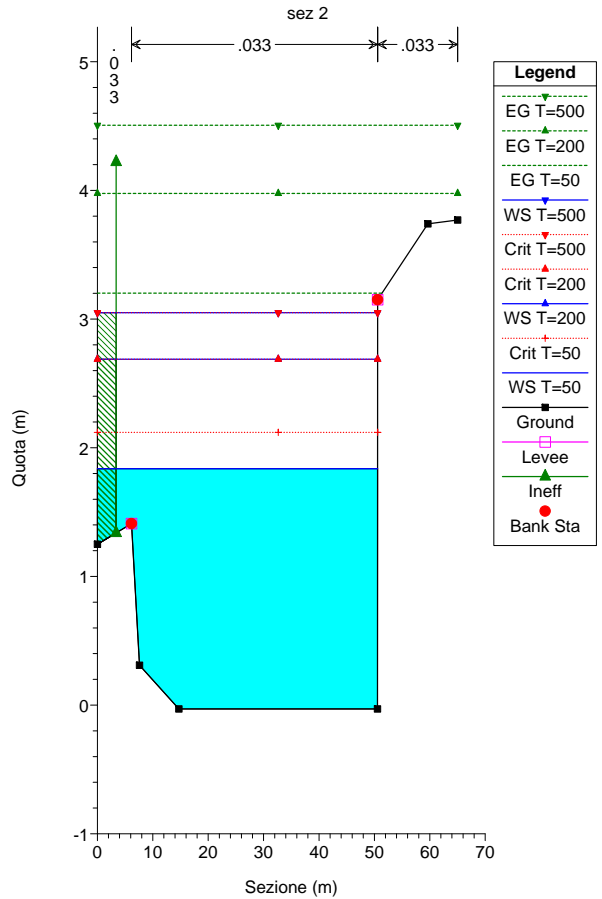
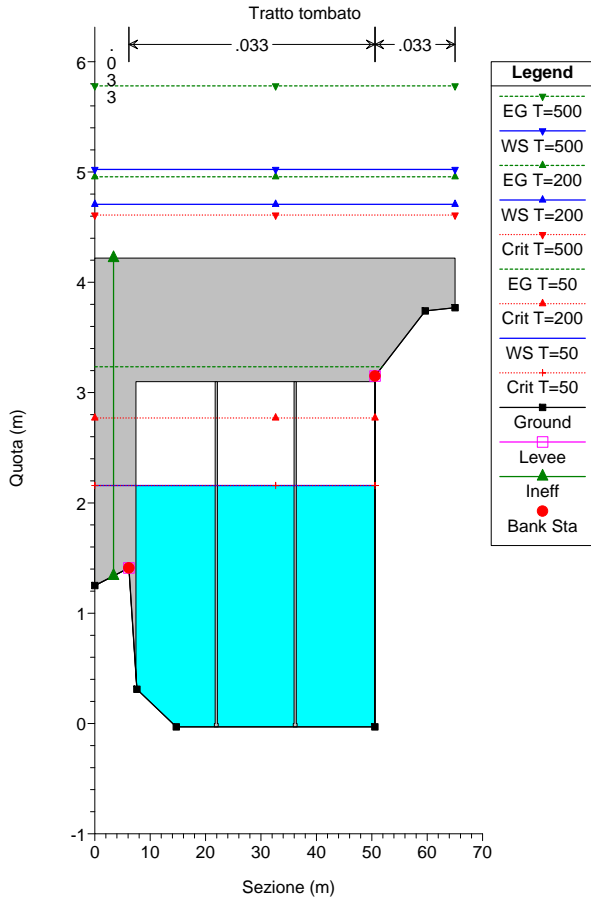
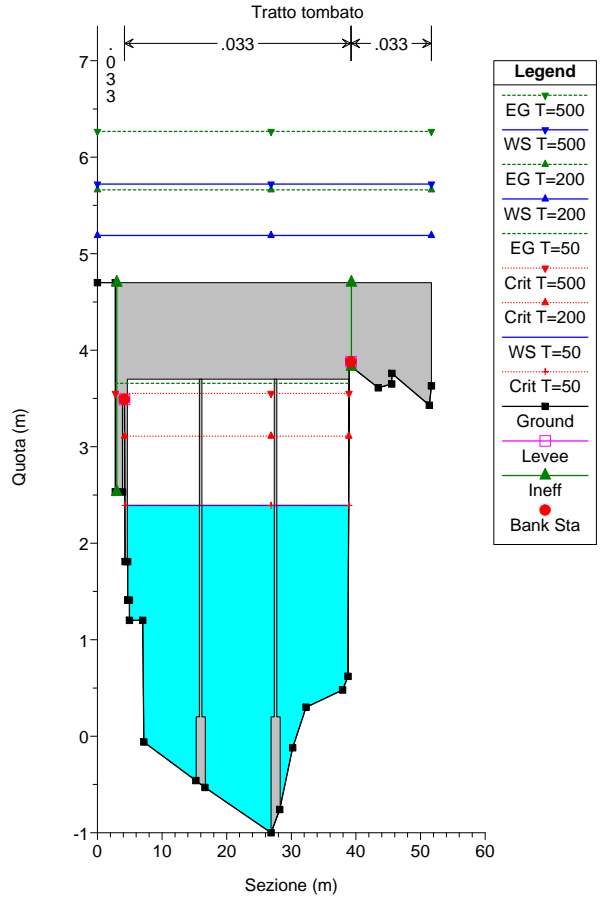
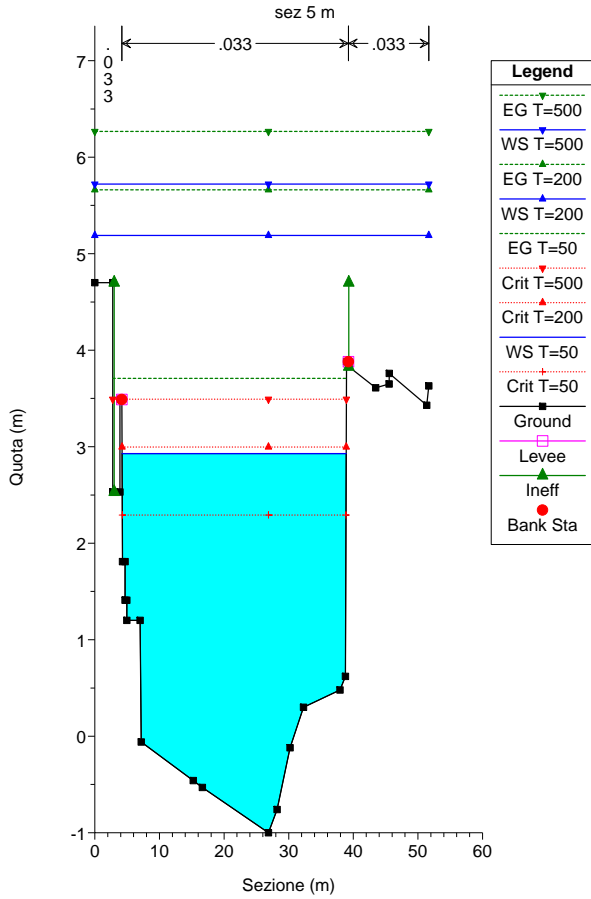

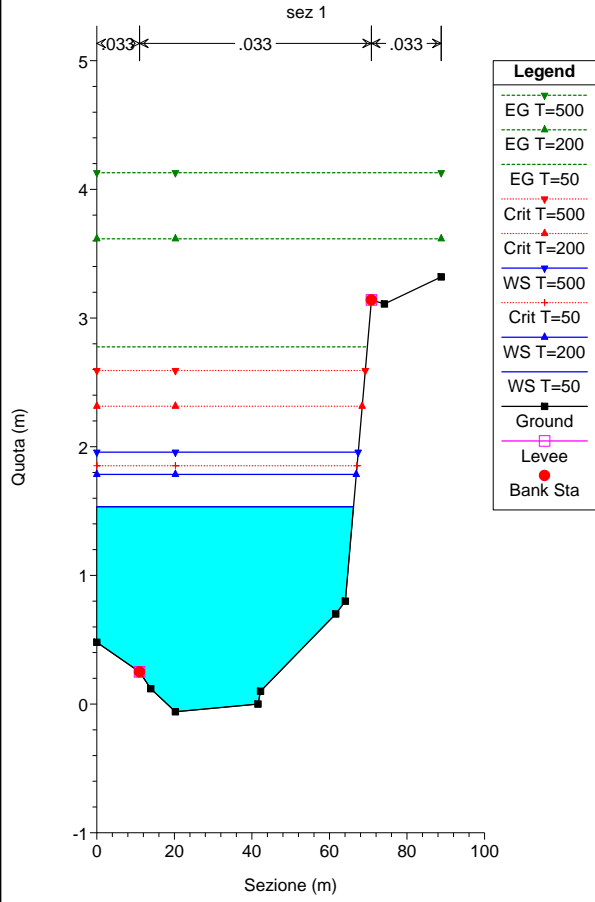

HEC-RAS Plan: attuale_sett_17 River: Maremola Reach: Foce

Reach	River Sta	Profile	Q Total (m3/s)	Min Ch El (m)	W.S. Elev (m)	LOB Elev (m)	L. Freeboard (m)	ROB Elev (m)	R. Freeboard (m)	Crit W.S. (m)	E.G. Elev (m)	E.G. Slope (m/m)	Vel Chnl (m/s)	Flow Area (m2)	Top Width (m)	Froude # Chl
Foce	50	T=50	420.00	6.10	10.57	9.97	-0.60	10.21	-0.36	9.46	10.95	0.002114	2.77	161.08	69.94	0.52
Foce	50	T=200	610.00	6.10	11.51	9.97	-1.54	10.21	-1.30	10.13	11.91	0.001609	2.91	226.60	69.94	0.47
Foce	50	T=500	740.00	6.10	12.12	9.97	-2.15	10.21	-1.91	10.55	12.54	0.001384	2.98	269.66	69.94	0.45
Foce	49	T=50	420.00	5.95	10.38	9.86	-0.52	10.08	-0.30	9.29	10.87	0.002274	3.16	142.93	50.99	0.54
Foce	49	T=200	610.00	5.95	11.23	9.86	-1.37	10.08	-1.15	9.98	11.83	0.002173	3.57	186.02	50.99	0.55
Foce	49	T=500	740.00	5.95	11.80	9.86	-1.94	10.08	-1.72	10.44	12.46	0.002046	3.76	215.16	50.99	0.54
Foce	48	T=50	420.00	5.91	10.18	9.83	-0.35	9.88	-0.30	9.24	10.80	0.002936	3.58	127.26	45.35	0.60
Foce	48	T=200	610.00	5.91	10.96	9.83	-1.13	9.88	-1.08	10.10	11.76	0.003001	4.13	162.49	45.35	0.63
Foce	48	T=500	740.00	5.91	11.50	9.83	-1.67	9.88	-1.62	10.49	12.39	0.002872	4.36	187.27	45.35	0.63
Foce	47	T=50	420.00	5.33	9.94	9.60	-0.34	9.69	-0.25	9.18	10.70	0.003668	4.00	116.21	41.51	0.65
Foce	47	T=200	610.00	5.33	10.59	9.60	-0.99	9.69	-0.90	10.08	11.64	0.004213	4.76	143.15	41.51	0.72
Foce	47	T=500	740.00	5.33	11.12	9.60	-1.52	9.69	-1.43	10.49	12.27	0.004059	5.04	164.96	41.51	0.72
Foce	45	T=50	420.00	5.22	9.98	9.50	-0.48	9.61	-0.37	8.88	10.63	0.002921	3.71	125.39	40.17	0.58
Foce	45	T=200	610.00	5.22	10.62	9.50	-1.12	9.61	-1.01	9.85	11.56	0.003558	4.50	151.24	40.17	0.65
Foce	45	T=500	740.00	5.22	11.13	9.50	-1.63	9.61	-1.52	10.26	12.20	0.003575	4.83	171.85	40.17	0.67
Foce	44	T=50	420.00	5.07	9.82	9.30	-0.52	9.43	-0.39	8.91	10.55	0.003236	3.94	118.47	38.80	0.62
Foce	44	T=200	610.00	5.07	10.28	9.30	-0.98	9.43	-0.85	9.84	11.45	0.004545	5.01	136.19	38.80	0.75
Foce	44	T=500	740.00	5.07	10.75	9.30	-1.45	9.43	-1.32	10.26	12.08	0.004606	5.39	154.41	38.80	0.77
Foce	43	T=50	420.00	4.93	9.04	9.03	-0.01	9.28	0.24	8.81	10.33	0.006817	5.11	86.09	28.83	0.87
Foce	43	T=200	610.00	4.93	9.68	9.03	-0.65	9.28	-0.40	9.68	11.20	0.007208	5.73	119.31	38.43	0.90
Foce	43	T=500	740.00	4.93	10.10	9.03	-1.07	9.28	-0.82	10.10	11.83	0.007290	6.15	135.51	38.43	0.92
Foce	42	T=50	420.00	4.83	9.25	8.48	-0.77	8.91	-0.34	8.62	10.06	0.003910	4.14	111.73	38.54	0.68
Foce	42	T=200	610.00	4.83	9.17	8.48	-0.69	8.91	-0.26	9.42	10.99	0.008959	6.18	108.58	38.54	1.02
Foce	42	T=500	740.00	4.83	9.58	8.48	-1.10	8.91	-0.67	9.85	11.61	0.008824	6.58	124.57	38.54	1.03
Foce	41	T=50	420.00	4.67	9.26	8.30	-0.96	8.76	-0.50	8.44	9.94	0.003132	3.79	122.16	40.10	0.62
Foce	41	T=200	610.00	4.67	9.57	8.30	-1.27	8.76	-0.81	9.20	10.75	0.004941	5.01	134.63	40.10	0.79
Foce	41	T=500	740.00	4.67	9.90	8.30	-1.60	8.76	-1.14	9.61	11.33	0.005486	5.56	147.81	40.10	0.84
Foce	40	T=50	420.00	4.49	8.39	8.07	-0.32	8.64	0.25	8.39	9.72	0.007819	5.19	84.24	31.57	0.96
Foce	40	T=200	610.00	4.49	9.12	8.07	-1.05	8.64	-0.48	9.12	10.54	0.006732	5.53	123.19	42.81	0.92
Foce	40	T=500	740.00	4.49	9.51	8.07	-1.44	8.64	-0.87	9.51	11.13	0.006741	5.93	140.17	42.81	0.93
Foce	39	T=50	420.00	4.33	7.74	7.81	0.07	8.38	0.64	8.06	9.41	0.012853	5.72	73.41	31.54	1.20
Foce	39	T=200	610.00	4.33	8.96	7.81	-1.15	8.38	-0.58	8.72	10.13	0.005645	4.95	133.56	44.49	0.84
Foce	39	T=500	740.00	4.33	9.57	7.81	-1.76	8.38	-1.19	9.10	10.76	0.004686	5.02	160.76	44.49	0.79
Foce	38	T=50	420.00	4.19	7.58	7.55	-0.03	8.19	0.61	7.82	9.10	0.010296	5.53	78.79	33.71	1.09

HEC-RAS Plan: attuale_sett_17 River: Maremola Reach: Foce (Continued)

Reach	River Sta	Profile	Q Total (m3/s)	Min Ch El (m)	W.S. Elev (m)	LOB Elev (m)	L. Freeboard (m)	ROB Elev (m)	R. Freeboard (m)	Crit W.S. (m)	E.G. Elev (m)	E.G. Slope (m/m)	Vel Chnl (m/s)	Flow Area (m2)	Top Width (m)	Froude # Chl
Foce	38	T=200	610.00	4.19	8.55	7.55	-1.00	8.19	-0.36	8.55	9.92	0.006762	5.38	124.97	45.63	0.92
Foce	38	T=500	740.00	4.19	9.49	7.55	-1.94	8.19	-1.30	8.93	10.60	0.004085	4.91	167.68	45.63	0.75
Foce	37	T=50	420.00	3.97	7.88	7.23	-0.65	7.01	-0.87	7.66	8.68	0.005251	4.11	111.98	50.19	0.78
Foce	37	T=200	610.00	3.97	8.60	7.23	-1.37	7.01	-1.59	8.22	9.55	0.004740	4.54	147.87	50.19	0.77
Foce	37	T=500	740.00	3.97	9.61	7.23	-2.38	7.01	-2.60	8.57	10.38	0.002793	4.12	198.42	50.19	0.62
Foce	36	T=50	420.00	3.84	7.73	7.02	-0.71	6.53	-1.20	7.46	8.50	0.004275	4.17	117.95	50.43	0.71
Foce	36	T=200	610.00	3.84	8.47	7.02	-1.45	6.53	-1.94	8.04	9.37	0.004035	4.60	155.20	50.43	0.71
Foce	36	T=500	740.00	3.84	9.56	7.02	-2.54	6.53	-3.03	8.38	10.26	0.002364	4.10	210.28	50.43	0.57
Foce	35	T=50	420.00	3.81	7.34	6.89	-0.45	6.50	-0.84	7.34	8.35	0.006055	4.72	103.49	49.34	0.84
Foce	35	T=200	610.00	3.81	8.31	6.89	-1.42	6.50	-1.81	7.92	9.26	0.004257	4.71	150.98	49.34	0.74
Foce	35	T=500	740.00	3.81	9.50	6.89	-2.61	6.50	-3.00	8.27	10.21	0.002307	4.10	209.77	49.34	0.57
Foce	34	T=50	420.00	3.65	7.17	6.78	-0.39	6.41	-0.76	7.17	8.18	0.006101	4.71	103.07	49.22	0.84
Foce	34	T=200	610.00	3.65	8.23	6.78	-1.45	6.41	-1.82	7.75	9.13	0.003907	4.56	155.07	49.22	0.71
Foce	34	T=500	740.00	3.65	9.47	6.78	-2.69	6.41	-3.06	8.10	10.13	0.002099	3.97	215.89	49.22	0.54
Foce	33	T=50	420.00	3.43	7.16	6.64	-0.52	7.03	-0.13	6.98	8.03	0.005262	4.36	110.19	49.87	0.78
Foce	33	T=200	610.00	3.43	8.23	6.64	-1.59	7.03	-1.20	7.59	9.03	0.003452	4.29	163.27	49.87	0.67
Foce	33	T=500	740.00	3.43	9.46	6.64	-2.82	7.03	-2.44	7.94	10.08	0.001902	3.78	224.92	49.87	0.52
Foce	32	T=50	420.00	3.42	7.13	6.54	-0.59	7.00	-0.13	6.89	7.93	0.004968	4.22	113.61	50.82	0.76
Foce	32	T=200	610.00	3.42	8.22	6.54	-1.68	7.00	-1.22	7.49	8.96	0.003171	4.12	169.26	50.82	0.64
Foce	32	T=500	740.00	3.42	9.47	6.54	-2.92	7.00	-2.47	7.83	10.03	0.001755	3.64	232.46	50.82	0.50
Foce	31	T=50	420.00	3.26	6.52	6.38	-0.14	7.05	0.53	6.52	7.71	0.007465	4.97	90.22	37.26	0.92
Foce	31	T=200	610.00	3.26	8.19	6.38	-1.81	7.05	-1.14	7.20	8.85	0.002559	3.87	179.67	49.30	0.57
Foce	31	T=500	740.00	3.26	9.44	6.38	-3.06	7.05	-2.39	7.55	9.97	0.001528	3.51	241.30	49.30	0.46
Foce	30	T=50	420.00	3.08	6.27	6.20	-0.07	6.40	0.13	6.29	7.51	0.007754	5.03	88.52	36.37	0.93
Foce	30	T=200	610.00	3.08	8.15	6.20	-1.95	6.40	-1.75	6.96	8.77	0.002227	3.73	185.08	47.46	0.54
Foce	30	T=500	740.00	3.08	9.41	6.20	-3.21	6.40	-3.01	7.32	9.93	0.001387	3.43	244.87	47.46	0.44
Foce	29	T=50	420.00	2.96	6.43	5.94	-0.49	6.11	-0.32	6.14	7.26	0.004788	4.22	111.02	45.64	0.75
Foce	29	T=200	610.00	2.96	8.10	5.94	-2.16	6.11	-1.99	6.76	8.70	0.002080	3.67	187.35	45.64	0.53
Foce	29	T=500	740.00	2.96	9.37	5.94	-3.43	6.11	-3.26	7.13	9.88	0.001330	3.42	245.42	45.64	0.44
Foce	28	T=50	420.00	2.86	6.45	5.69	-0.76	5.87	-0.58	5.96	7.07	0.003492	3.72	129.37	51.83	0.64
Foce	28	T=200	610.00	2.86	8.16	5.69	-2.47	5.87	-2.29	6.52	8.60	0.001510	3.20	217.66	51.83	0.45
Foce	28	T=500	740.00	2.86	9.43	5.69	-3.74	5.87	-3.56	6.86	9.81	0.000978	2.99	283.67	51.83	0.38
Foce	27	T=50	420.00	2.79	6.37	5.55	-0.82	5.67	-0.70	5.84	6.96	0.003377	3.66	131.63	51.98	0.63
Foce	27	T=200	610.00	2.79	8.13	5.55	-2.58	5.67	-2.46	6.39	8.55	0.001411	3.13	223.27	51.98	0.44

HEC-RAS Plan: attuale_sett_17 River: Maremola Reach: Foce (Continued)

Reach	River Sta	Profile	Q Total (m3/s)	Min Ch El (m)	W.S. Elev (m)	LOB Elev (m)	L. Freeboard (m)	ROB Elev (m)	R. Freeboard (m)	Crit W.S. (m)	E.G. Elev (m)	E.G. Slope (m/m)	Vel Chnl (m/s)	Flow Area (m2)	Top Width (m)	Froude # Chl
Foce	27	T=500	740.00	2.79	9.41	5.55	-3.86	5.67	-3.74	6.73	9.78	0.000921	2.93	290.06	51.98	0.37
Foce	26	T=50	420.00	2.56	6.33	5.44	-0.89	5.49	-0.84	5.63	6.84	0.002689	3.39	141.55	52.30	0.57
Foce	26	T=200	610.00	2.56	8.12	5.44	-2.68	5.49	-2.63	6.18	8.50	0.001196	2.96	234.91	52.30	0.41
Foce	26	T=500	740.00	2.56	9.41	5.44	-3.97	5.49	-3.92	6.51	9.74	0.000804	2.80	302.34	52.30	0.35
Foce	25	T=50	420.00	2.47	6.04	5.29	-0.75	5.37	-0.67	5.55	6.73	0.003837	3.89	121.35	45.99	0.68
Foce	25	T=200	610.00	2.47	7.97	5.29	-2.68	5.37	-2.60	6.14	8.45	0.001489	3.28	210.22	45.99	0.46
Foce	25	T=500	740.00	2.47	9.28	5.29	-3.99	5.37	-3.91	6.51	9.71	0.001000	3.12	270.53	45.99	0.39
Foce	24	T=50	420.00	2.26	5.86	5.08	-0.78	5.12	-0.74	5.37	6.60	0.003980	4.00	116.64	42.37	0.69
Foce	24	T=200	610.00	2.26	7.88	5.08	-2.80	5.12	-2.76	6.00	8.40	0.001544	3.39	202.07	42.37	0.46
Foce	24	T=500	740.00	2.26	9.20	5.08	-4.12	5.12	-4.08	6.38	9.67	0.001062	3.25	258.05	42.37	0.40
Foce	23	T=50	420.00	2.04	5.77	4.88	-0.89	5.01	-0.76	5.27	6.47	0.003805	3.93	119.65	44.29	0.68
Foce	23	T=200	610.00	2.04	7.87	4.88	-2.99	5.01	-2.86	5.88	8.34	0.001363	3.24	212.79	44.29	0.44
Foce	23	T=500	740.00	2.04	9.21	4.88	-4.33	5.01	-4.20	6.25	9.63	0.000938	3.10	271.80	44.29	0.38
Foce	22	T=50	420.00	1.87	5.46	4.66	-0.80	4.80	-0.66	5.20	6.32	0.005232	4.35	107.63	43.30	0.79
Foce	22	T=200	610.00	1.87	7.82	4.66	-3.16	4.80	-3.02	5.81	8.29	0.001393	3.28	209.94	43.30	0.45
Foce	22	T=500	740.00	1.87	9.16	4.66	-4.50	4.80	-4.36	6.19	9.60	0.000955	3.15	268.18	43.30	0.39
Foce	21	T=50	420.00	1.75	5.17	4.57	-0.60	4.59	-0.58	5.06	6.14	0.006243	4.59	102.16	44.35	0.86
Foce	21	T=200	610.00	1.75	7.81	4.57	-3.24	4.59	-3.22	5.66	8.24	0.001236	3.15	218.90	44.35	0.43
Foce	21	T=500	740.00	1.75	9.16	4.57	-4.59	4.59	-4.57	6.03	9.56	0.000853	3.03	278.92	44.35	0.37
Foce	20	T=50	420.00	1.48	5.11	4.38	-0.73	4.49	-0.62	4.82	5.93	0.004902	4.21	110.75	45.43	0.77
Foce	20	T=200	610.00	1.48	7.81	4.38	-3.43	4.49	-3.32	5.43	8.19	0.001025	2.95	233.40	45.43	0.39
Foce	20	T=500	740.00	1.48	9.16	4.38	-4.78	4.49	-4.67	5.79	9.52	0.000726	2.86	295.04	45.43	0.34
Foce	19	T=50	420.00	1.46	5.12	4.13	-0.99	4.38	-0.74	4.61	5.68	0.003379	3.54	133.77	55.63	0.65
Foce	19	T=200	610.00	1.46	7.87	4.13	-3.74	4.38	-3.49	5.13	8.12	0.000660	2.40	286.78	55.63	0.32
Foce	19	T=500	740.00	1.46	9.23	4.13	-5.10	4.38	-4.85	5.45	9.46	0.000466	2.32	362.48	55.63	0.28
Foce	18	T=50	420.00	1.37	5.05	5.00	-0.05	4.10	-0.95	4.58	5.51	0.003032	3.28	147.17	66.24	0.61
Foce	18	T=200	610.00	1.37	7.89	5.00	-2.89	4.10	-3.79	5.00	8.08	0.000515	2.13	335.97	67.04	0.28
Foce	18	T=500	740.00	1.37	9.26	5.00	-4.26	4.10	-5.16	5.27	9.43	0.000356	2.03	427.65	67.04	0.24
Foce	17.75	T=50	420.00	1.31	5.10	3.75	-1.35	4.11	-0.99	4.35	5.43	0.002405	2.84	172.07	74.48	0.53
Foce	17.75	T=200	610.00	1.31	7.91	3.75	-4.16	4.11	-3.80	4.78	8.05	0.000436	1.90	382.64	75.44	0.25
Foce	17.75	T=500	740.00	1.31	9.28	3.75	-5.53	4.11	-5.17	5.03	9.41	0.000301	1.82	485.74	75.44	0.22
Foce	17.5	T=50	420.00	1.25	5.04	4.08	-0.96	4.67	-0.37	4.25	5.40	0.002209	2.84	166.33	64.17	0.50
Foce	17.5	T=200	610.00	1.25	7.88	4.08	-3.80	4.67	-3.21	4.67	8.05	0.000456	1.97	348.68	64.17	0.25
Foce	17.5	T=500	740.00	1.25	9.24	4.08	-5.16	4.67	-4.57	4.95	9.40	0.000331	1.92	436.32	64.17	0.22

HEC-RAS Plan: attuale_sett_17 River: Maremola Reach: Foce (Continued)

Reach	River Sta	Profile	Q Total (m3/s)	Min Ch El (m)	W.S. Elev (m)	LOB Elev (m)	L. Freeboard (m)	ROB Elev (m)	R. Freeboard (m)	Crit W.S. (m)	E.G. Elev (m)	E.G. Slope (m/m)	Vel Chnl (m/s)	Flow Area (m2)	Top Width (m)	Froude # Chl
Foce	17.3	Bridge														
Foce	17	T=50	420.00	1.09	4.94	4.15	-0.79	4.63	-0.31	4.63	5.30	0.002092	2.83	165.26	63.81	0.51
Foce	17	T=200	610.00	1.09	7.87	4.15	-3.72	4.63	-3.24	4.63	8.03	0.000405	1.93	352.05	63.81	0.25
Foce	17	T=500	740.00	1.09	9.23	4.15	-5.08	4.63	-4.60	4.84	9.39	0.000296	1.89	439.44	63.81	0.22
Foce	16	T=50	420.00	0.89	4.90	4.04	-0.86	4.13	-0.77	4.05	5.21	0.001793	2.64	175.83	62.35	0.47
Foce	16	T=200	610.00	0.89	7.86	4.04	-3.82	4.13	-3.73	4.29	8.01	0.000387	1.89	360.00	62.35	0.24
Foce	16	T=500	740.00	0.89	9.23	4.04	-5.19	4.13	-5.10	4.59	9.38	0.000290	1.87	445.47	62.35	0.22
Foce	15	T=50	420.00	0.82	4.90	3.97	-0.93	3.58	-1.32	3.58	5.17	0.001376	2.48	186.80	61.48	0.42
Foce	15	T=200	610.00	0.82	7.85	3.97	-3.88	3.58	-4.27	4.09	8.00	0.000336	1.85	368.54	61.48	0.23
Foce	15	T=500	740.00	0.82	9.23	3.97	-5.26	3.58	-5.65	4.39	9.37	0.000258	1.84	452.82	61.48	0.21
Foce	14	T=50	420.00	0.75	4.87	3.29	-1.58	3.43	-1.44	3.30	5.12	0.001148	2.38	194.10	57.10	0.39
Foce	14	T=200	610.00	0.75	7.84	3.29	-4.55	3.43	-4.41	3.81	7.99	0.000327	1.87	363.56	57.10	0.23
Foce	14	T=500	740.00	0.75	9.21	3.29	-5.92	3.43	-5.78	4.12	9.36	0.000259	1.89	441.75	57.10	0.21
Foce	13	T=50	420.00	0.71	4.87	3.10	-1.77	3.32	-1.55	3.12	5.08	0.000923	2.19	211.59	58.59	0.35
Foce	13	T=200	610.00	0.71	7.84	3.10	-4.74	3.32	-4.52	3.56	7.98	0.000288	1.78	385.68	58.59	0.22
Foce	13	T=500	740.00	0.71	9.21	3.10	-6.11	3.32	-5.89	3.86	9.35	0.000233	1.80	465.94	58.59	0.20
Foce	12	T=50	420.00	0.19	4.82	3.03	-1.79	3.24	-1.58	3.24	5.07	0.001049	2.32	198.55	50.27	0.36
Foce	12	T=200	610.00	0.19	7.80	3.03	-4.77	3.24	-4.56	3.35	7.97	0.000366	1.96	348.16	50.27	0.23
Foce	12	T=500	740.00	0.19	9.16	3.03	-6.13	3.24	-5.92	3.76	9.34	0.000303	2.00	416.83	50.27	0.22
Foce	11.5	Bridge														
Foce	11	T=50	420.00	0.16	4.28	2.45	-1.83	2.80	-1.48	2.91	4.65	0.001813	2.82	163.31	48.52	0.46
Foce	11	T=200	610.00	0.16	6.47	2.45	-4.02	2.80	-3.67	3.52	6.75	0.000787	2.52	269.25	48.52	0.33
Foce	11	T=500	740.00	0.16	7.60	2.45	-5.15	2.80	-4.80	3.87	7.90	0.000643	2.56	324.29	48.52	0.31
Foce	10	T=50	420.00	0.06	4.29	2.43	-1.86	2.92	-1.37	2.92	4.63	0.001519	2.71	169.11	50.14	0.46
Foce	10	T=200	610.00	0.06	6.48	2.43	-4.05	2.92	-3.56	3.45	6.74	0.000646	2.43	278.53	50.14	0.32
Foce	10	T=500	740.00	0.06	7.61	2.43	-5.18	2.92	-4.69	3.79	7.89	0.000524	2.46	335.44	50.14	0.30
Foce	9	T=50	420.00	0.03	4.37	2.38	-1.99	2.78	-1.59	2.86	4.56	0.000898	2.10	224.77	71.99	0.35
Foce	9	T=200	610.00	0.03	6.56	2.38	-4.18	2.78	-3.78	3.28	6.70	0.000349	1.80	382.03	71.99	0.24
Foce	9	T=500	740.00	0.03	7.70	2.38	-5.32	2.78	-4.92	3.55	7.84	0.000277	1.80	464.25	71.99	0.22
Foce	8	T=50	420.00	-0.04	4.38	2.20	-2.18	2.53	-1.85	2.45	4.53	0.000600	1.85	252.88	71.96	0.29
Foce	8	T=200	610.00	-0.04	6.56	2.20	-4.36	2.53	-4.03	2.89	6.68	0.000281	1.68	416.43	86.17	0.21
Foce	8	T=500	740.00	-0.04	7.71	2.20	-5.51	2.53	-5.18	3.17	7.82	0.000219	1.65	515.37	86.17	0.19

HEC-RAS Plan: attuale_sett_17 River: Maremola Reach: Foce (Continued)

Reach	River Sta	Profile	Q Total (m3/s)	Min Ch El (m)	W.S. Elev (m)	LOB Elev (m)	L. Freeboard (m)	ROB Elev (m)	R. Freeboard (m)	Crit W.S. (m)	E.G. Elev (m)	E.G. Slope (m/m)	Vel Chnl (m/s)	Flow Area (m2)	Top Width (m)	Froude # Chl
Foce	7.5		Bridge													
Foce	7	T=50	420.00	-0.35	3.55	3.34	-0.21	2.98	-0.57	2.53	4.02	0.002534	3.13	143.60	53.91	0.55
Foce	7	T=200	610.00	-0.35	5.34	3.34	-2.00	2.98	-2.36	3.28	5.70	0.001111	2.76	240.49	54.07	0.39
Foce	7	T=500	740.00	-0.35	5.89	3.34	-2.55	2.98	-2.91	3.64	6.30	0.001138	2.99	270.15	54.07	0.40
Foce	6	T=50	420.00	-0.09	2.72	3.34	0.62	3.33	0.61	2.72	3.92	0.009072	4.86	86.49	36.25	1.00
Foce	6	T=200	610.00	-0.09	5.20	3.34	-1.86	3.33	-1.87	3.49	5.67	0.001522	3.14	210.06	51.58	0.45
Foce	6	T=500	740.00	-0.09	5.74	3.34	-2.40	3.33	-2.41	3.89	6.28	0.001533	3.38	237.74	51.58	0.46
Foce	5	T=50	420.00	-1.00	2.93	3.49	0.56	3.88	0.95	2.29	3.71	0.004447	3.91	107.32	34.68	0.71
Foce	5	T=200	610.00	-1.00	5.19	3.49	-1.70	3.88	-1.31	3.00	5.66	0.001427	3.11	210.30	51.68	0.43
Foce	5	T=500	740.00	-1.00	5.72	3.49	-2.23	3.88	-1.84	3.49	6.27	0.001469	3.36	237.86	51.68	0.44
Foce	4		Bridge													
Foce	2	T=50	420.00	-0.03	1.84	1.41	-0.43	3.15	1.31	2.12	3.20	0.014193	5.19	81.69	50.58	1.23
Foce	2	T=200	610.00	-0.03	2.69	1.41	-1.28	3.15	0.46	2.69	3.98	0.008259	5.06	121.89	50.58	0.99
Foce	2	T=500	740.00	-0.03	3.05	1.41	-1.64	3.15	0.10	3.05	4.51	0.007957	5.38	138.98	50.58	0.99
Foce	1	T=50	420.00	-0.06	1.53	0.25	-1.28	3.14	1.61	1.85	2.78	0.019148	5.02	85.33	66.19	1.40
Foce	1	T=200	610.00	-0.06	1.79	0.25	-1.54	3.14	1.35	2.31	3.62	0.022698	6.09	102.06	66.92	1.56
Foce	1	T=500	740.00	-0.06	1.96	0.25	-1.71	3.14	1.18	2.59	4.13	0.023642	6.63	113.68	67.42	1.62

Torrente Maremola e Rio Giustenice Plan: _settembre_2017_portate

Maremola Tovo

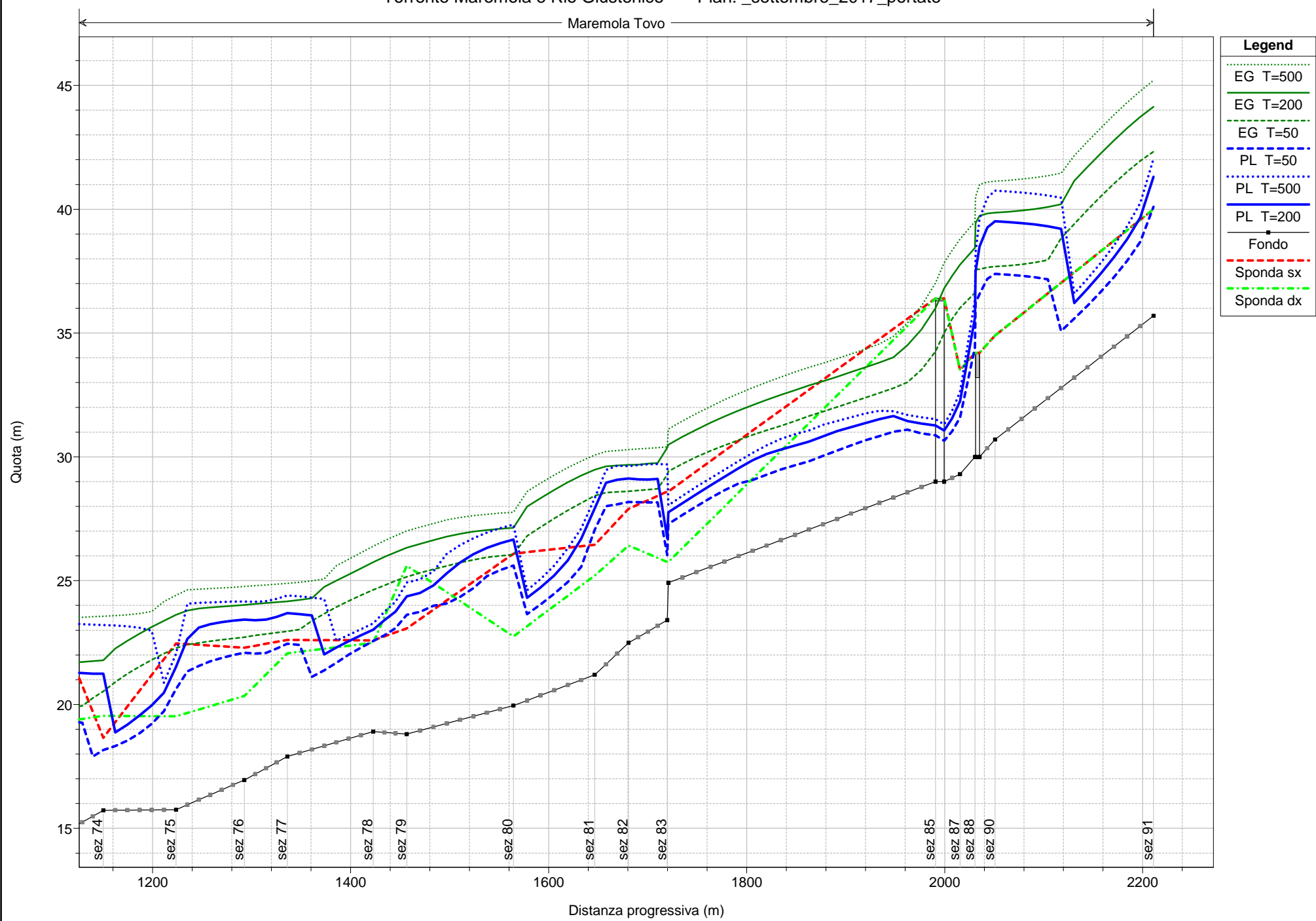

1 cm Horiz. = 50 m 1 cm Vert. = 2 m

Torrente Maremola e Rio Giustenice Plan: _settembre_2017_portate

Maremola Tovo

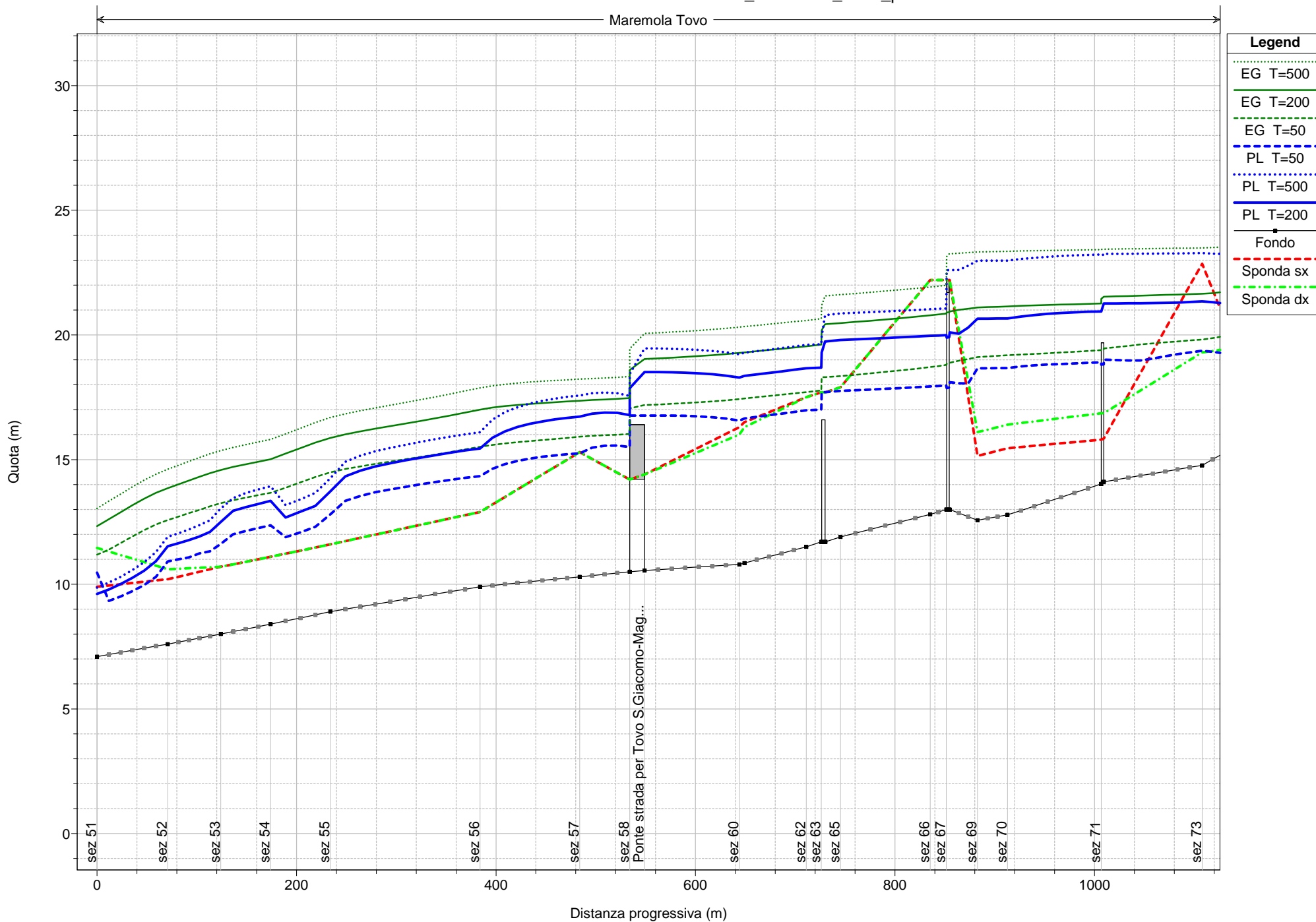

1 cm Horiz. = 50 m 1 cm Vert. = 2 m

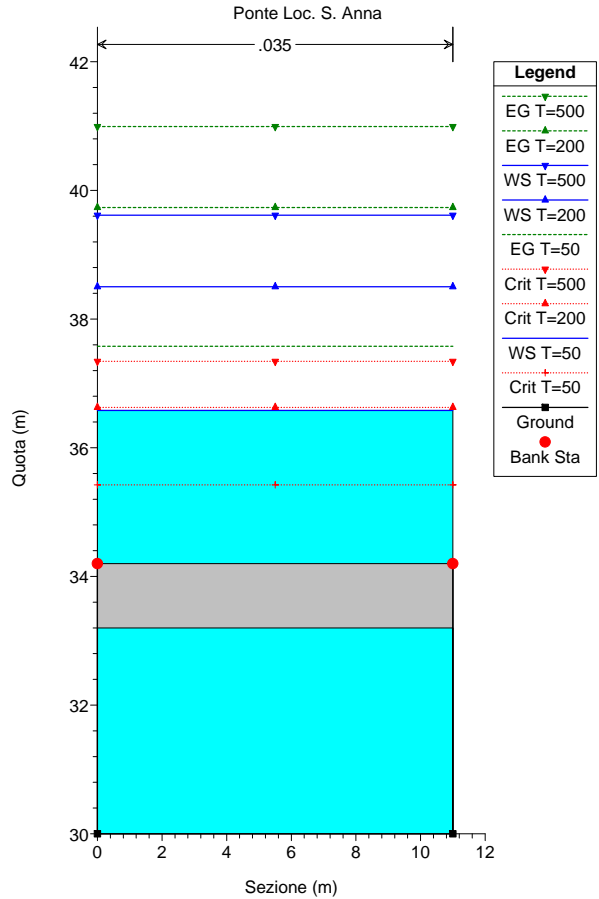
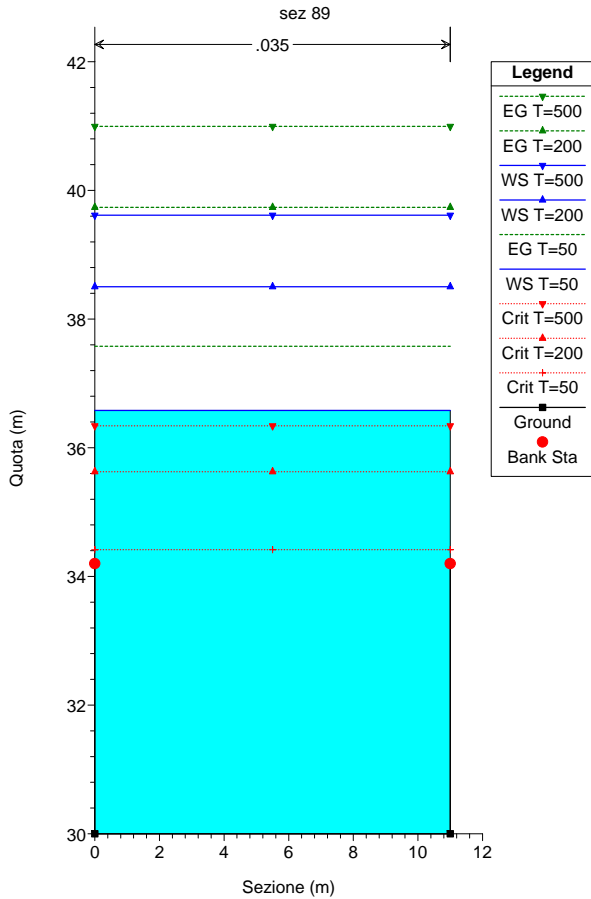
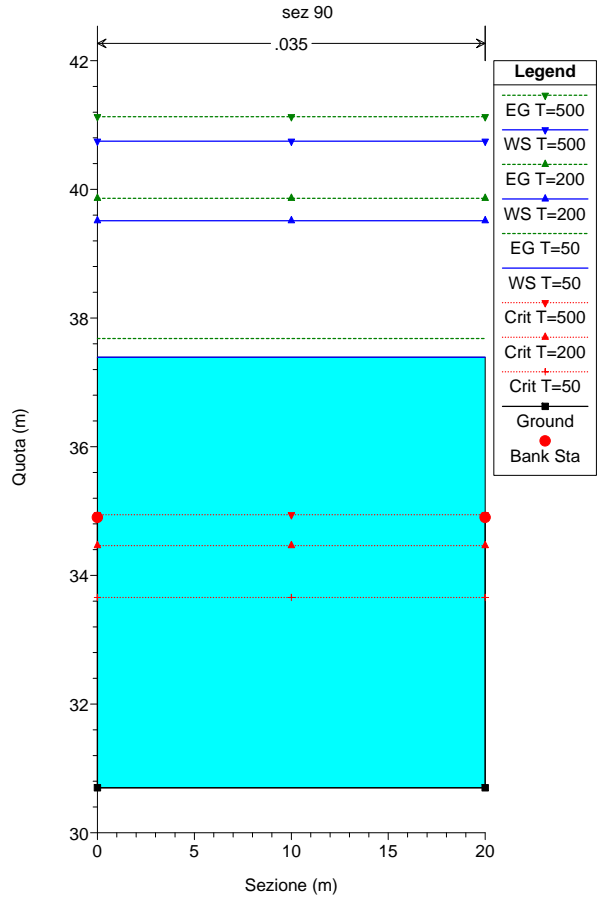
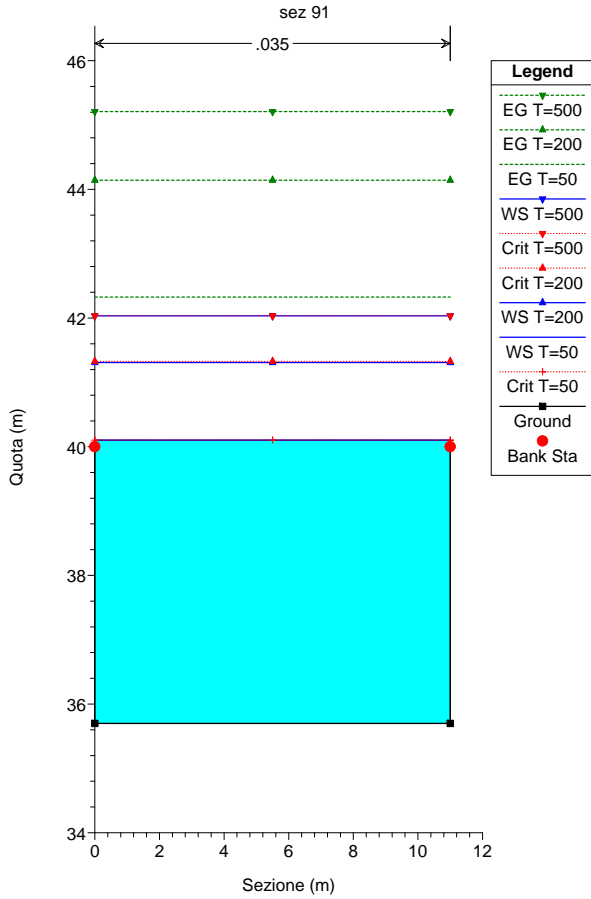

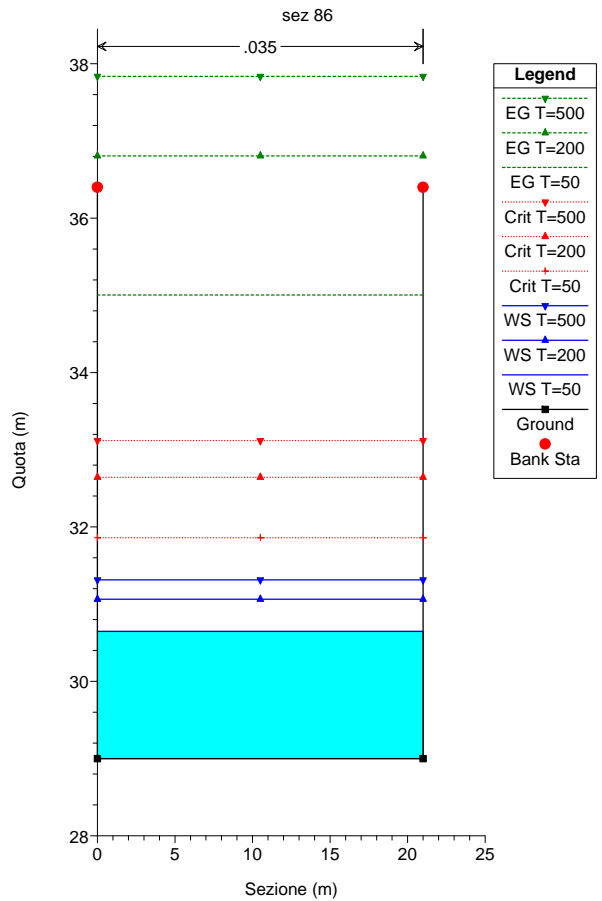
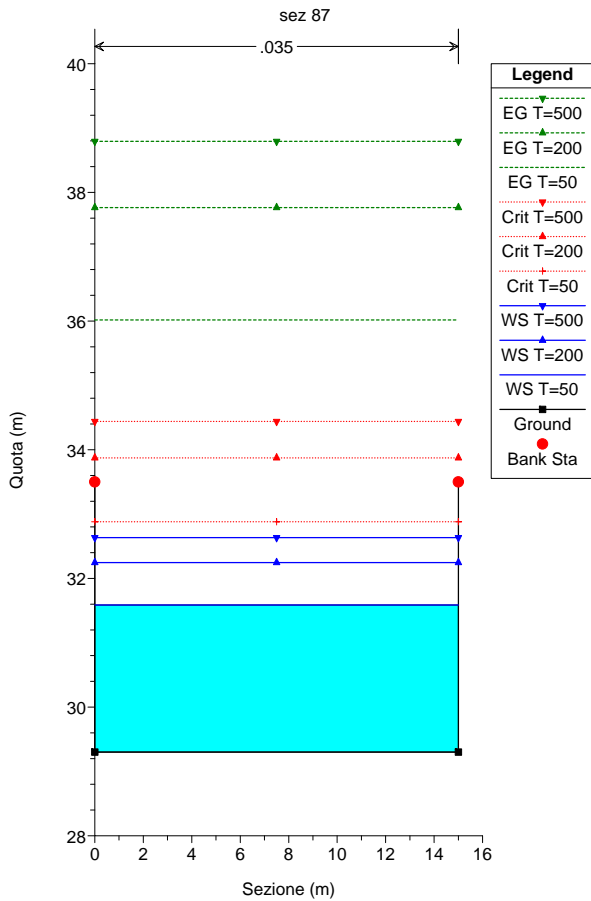
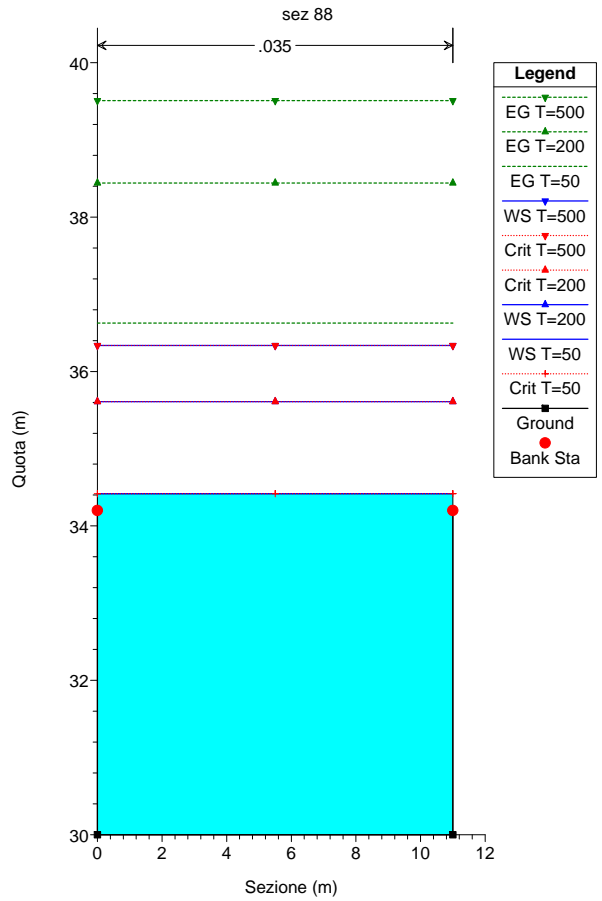
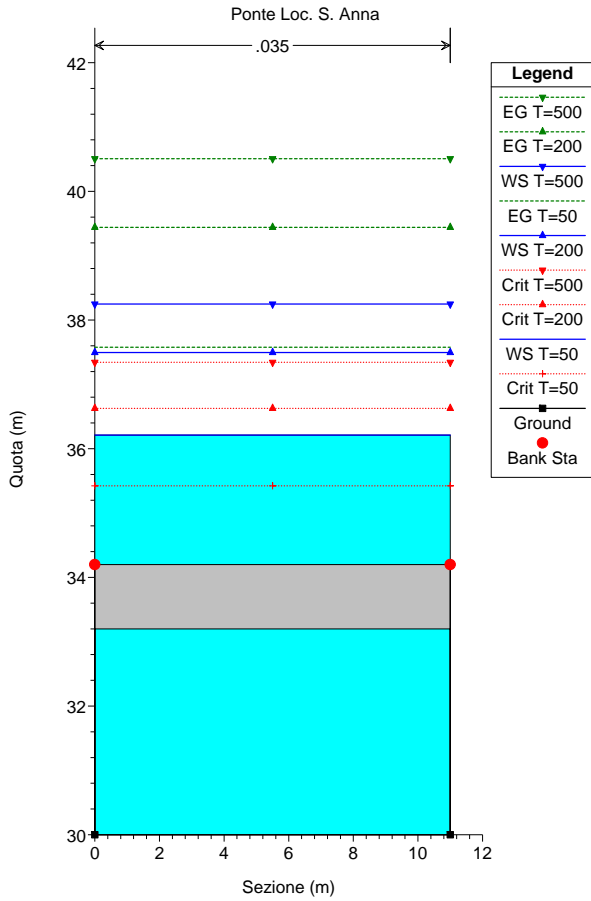

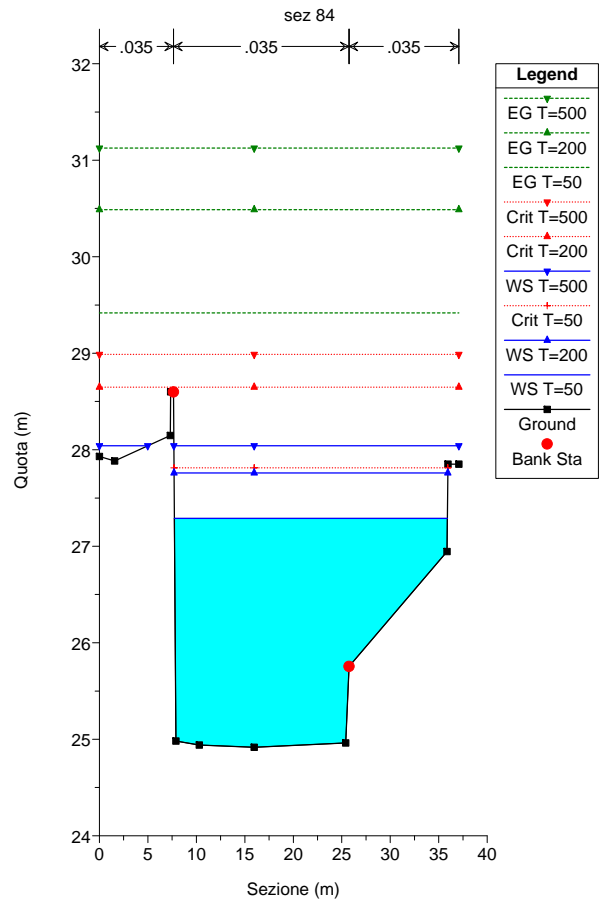
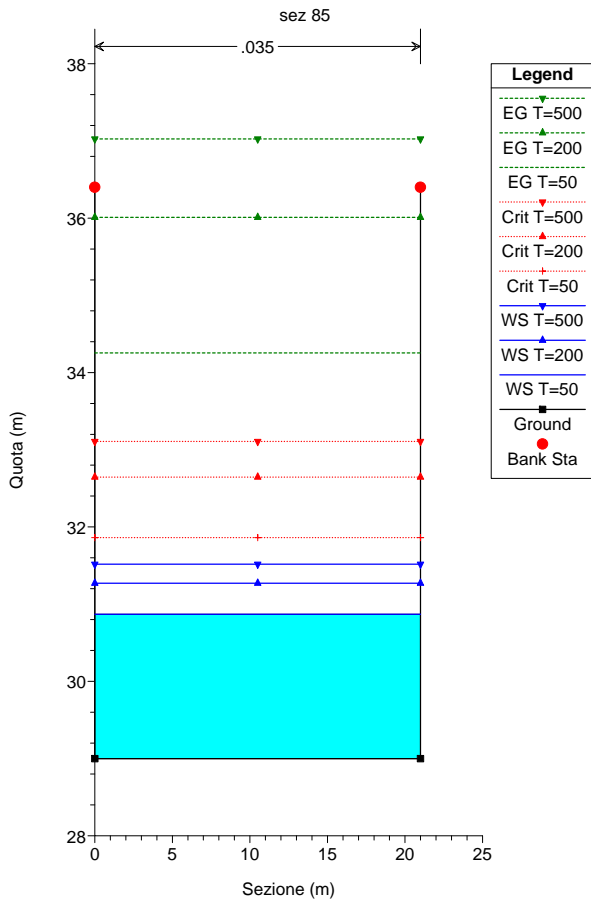
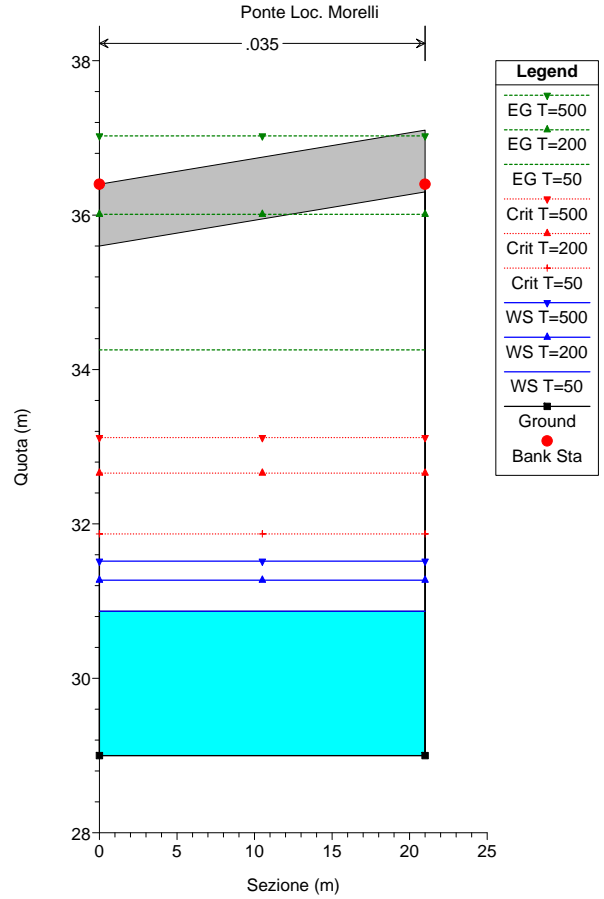
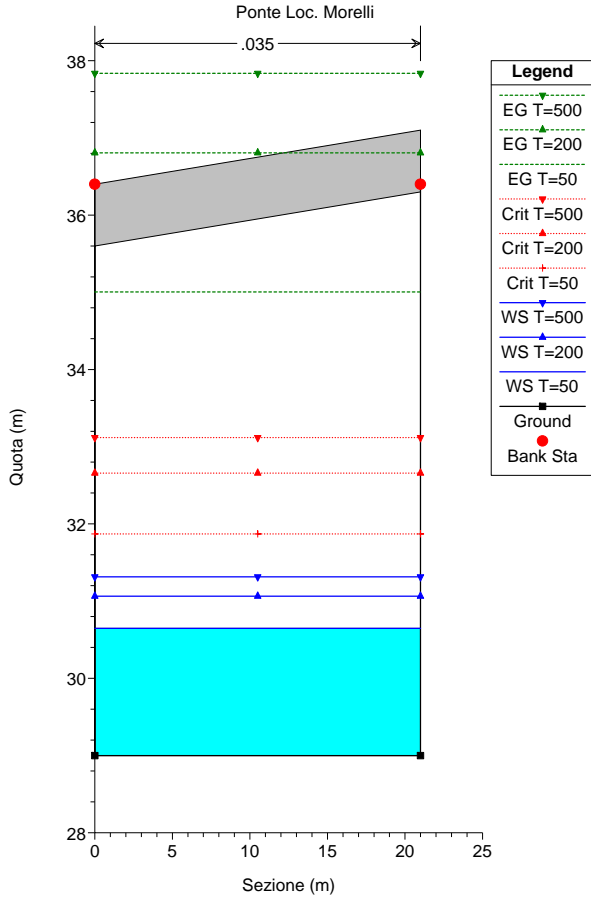

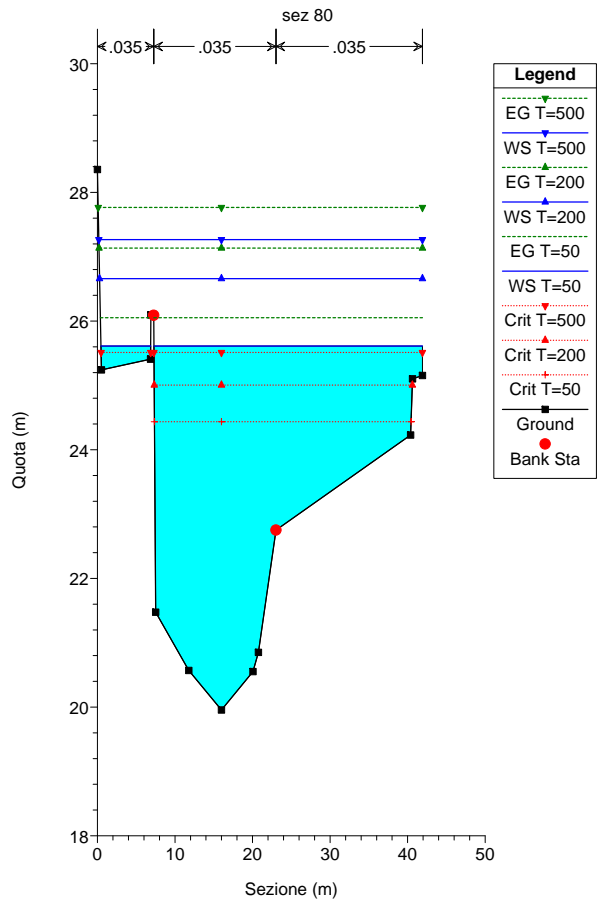
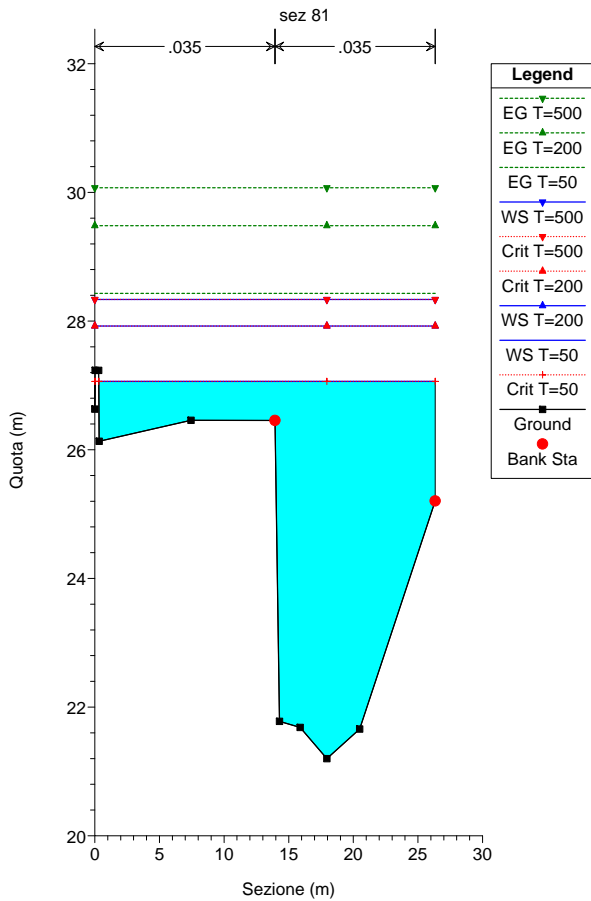
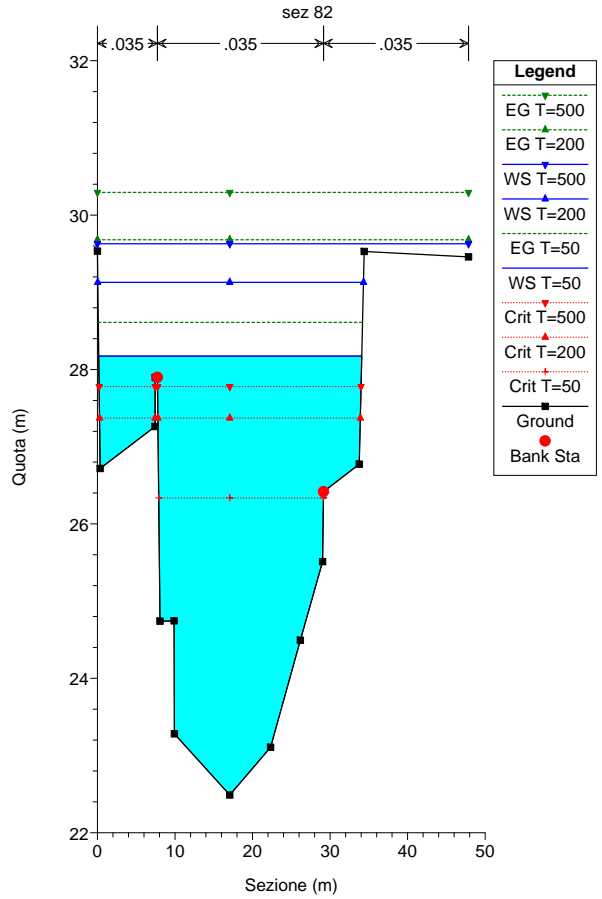
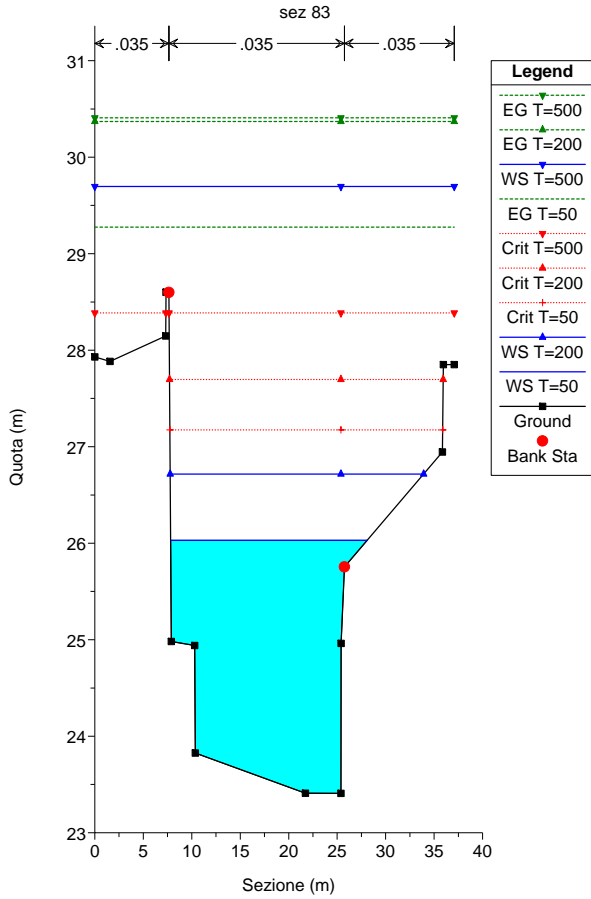

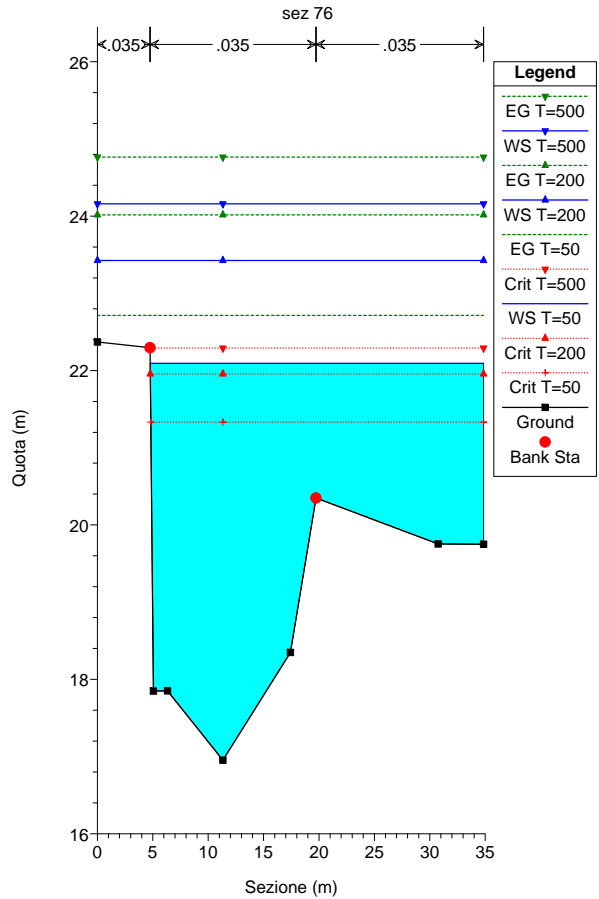
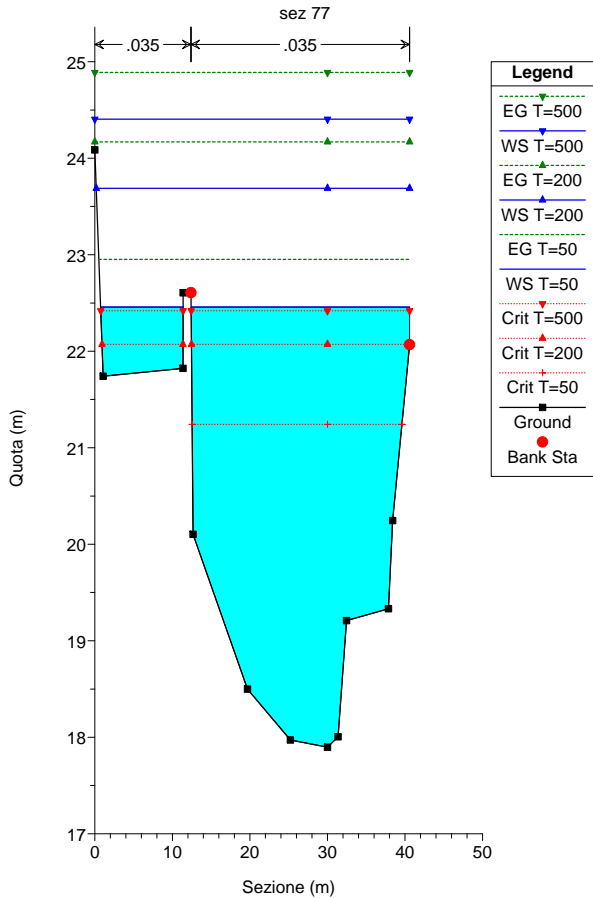
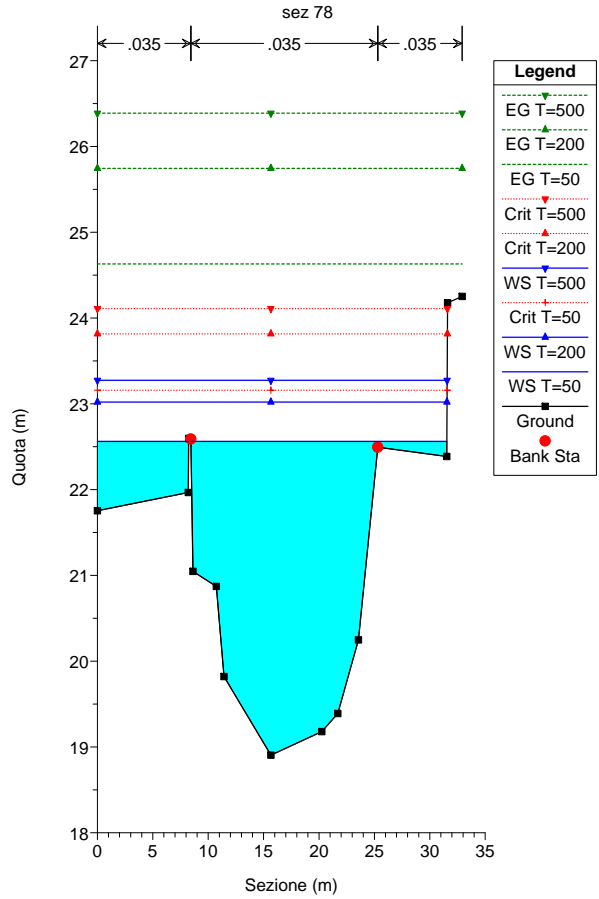
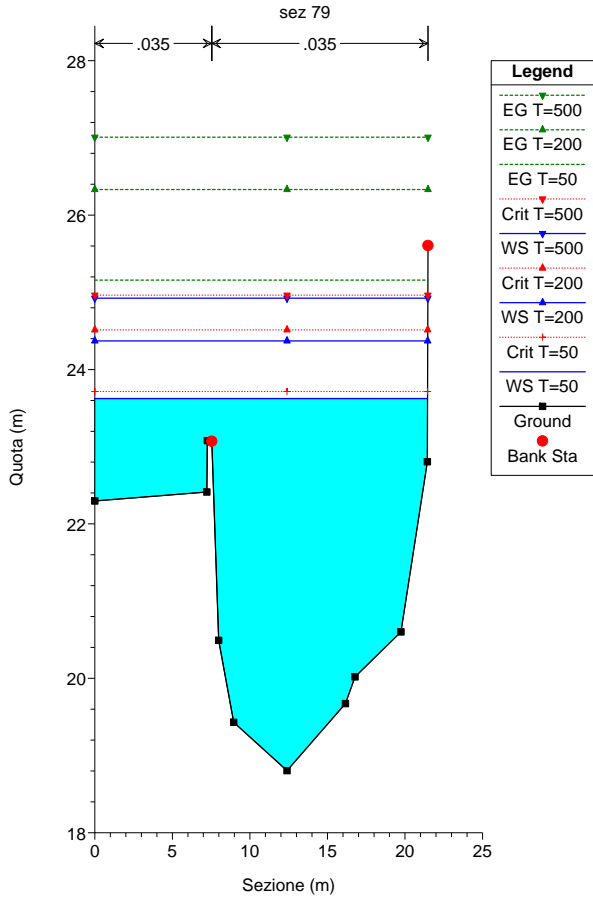

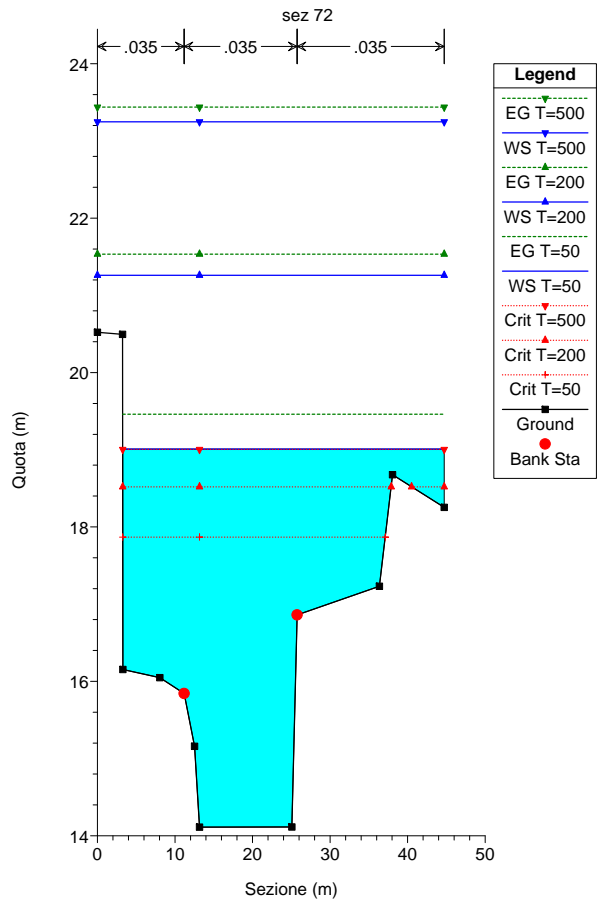
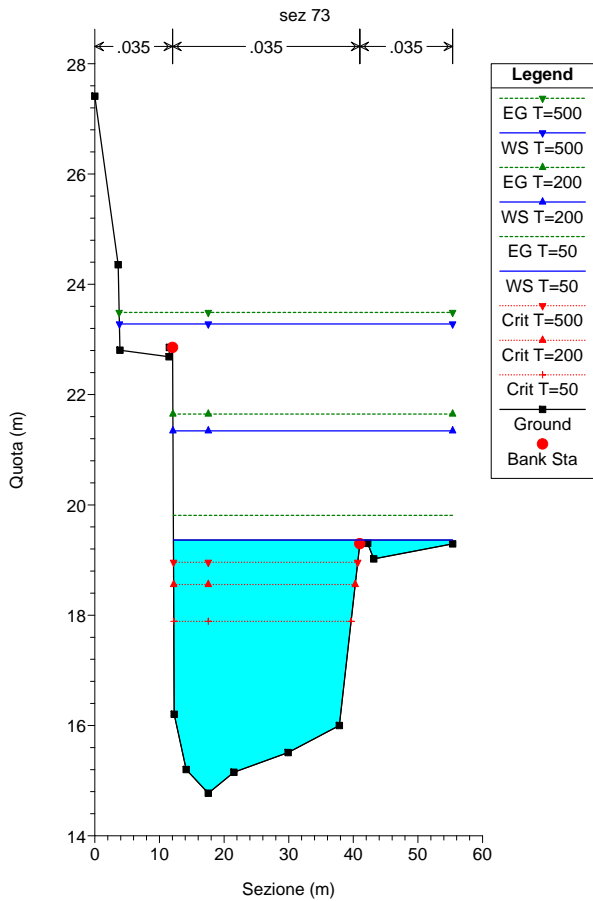
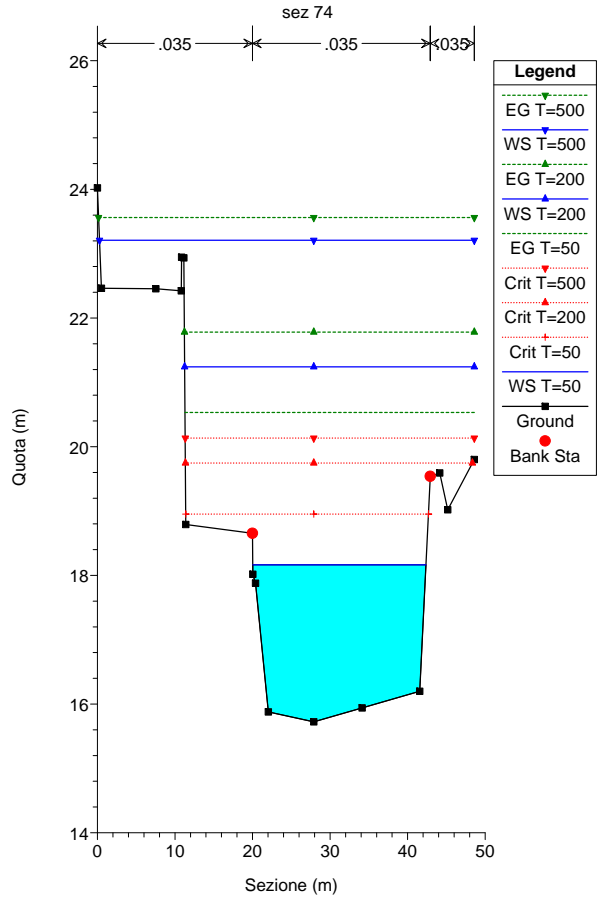
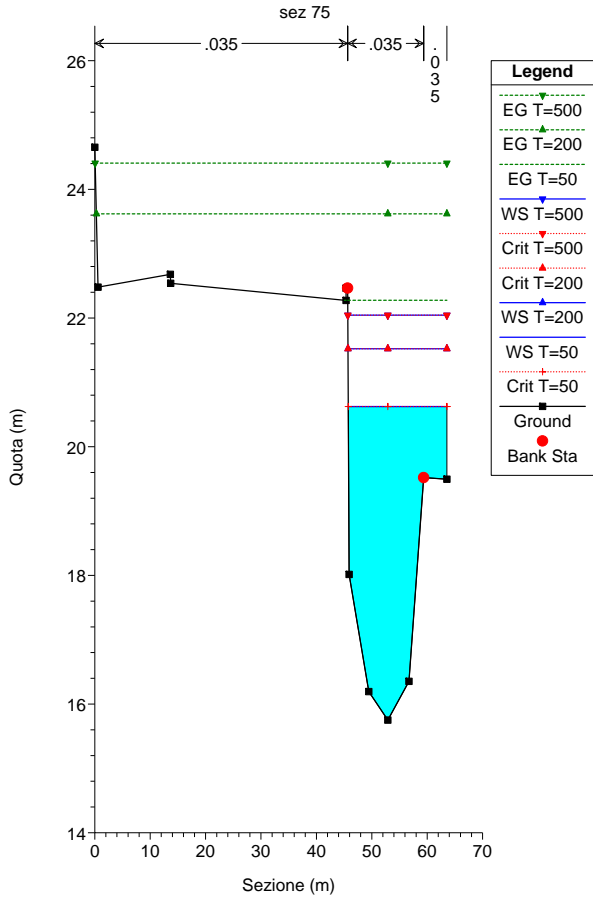

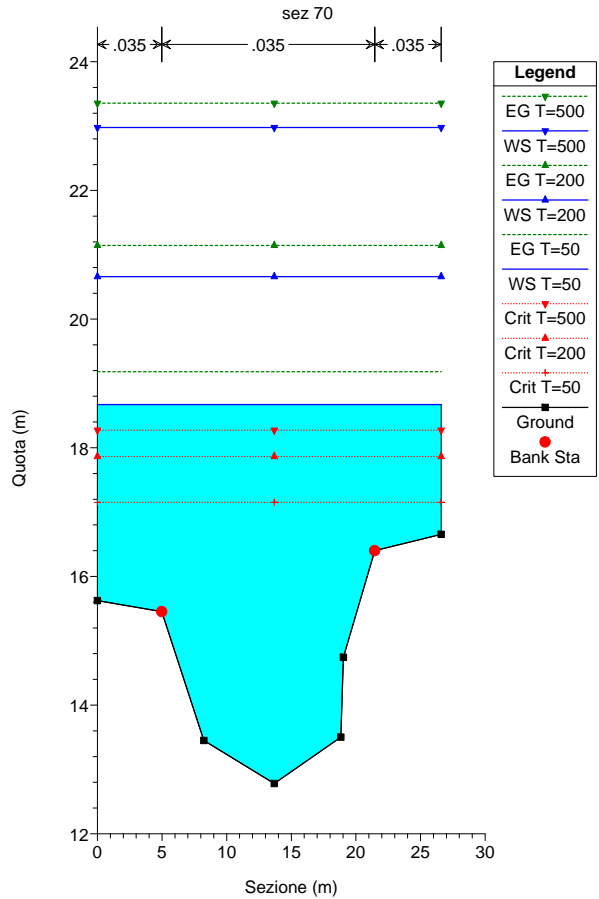
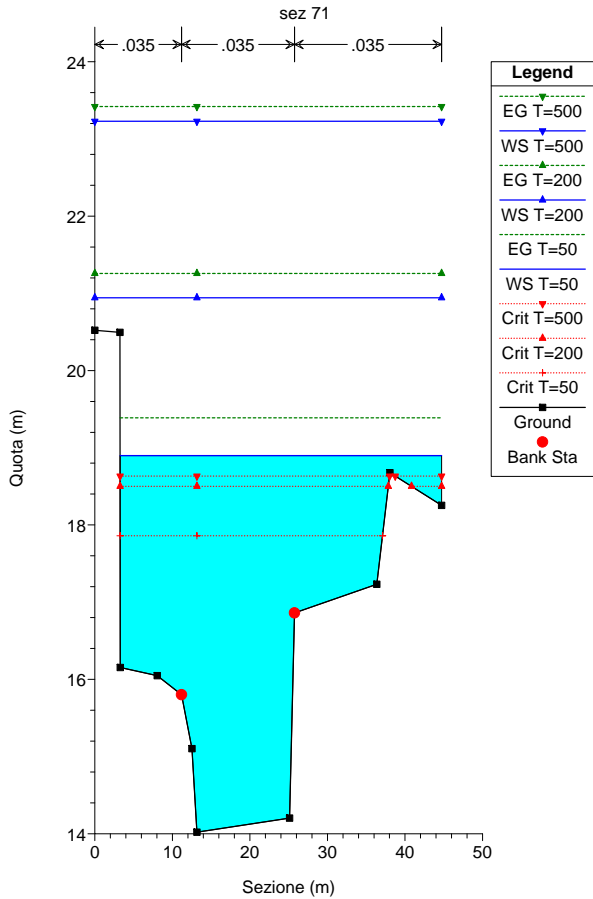
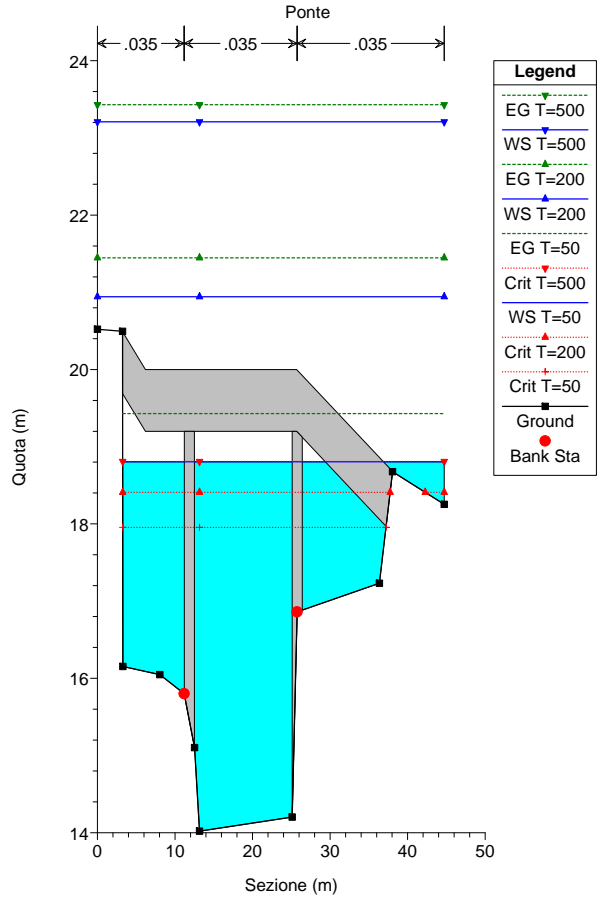
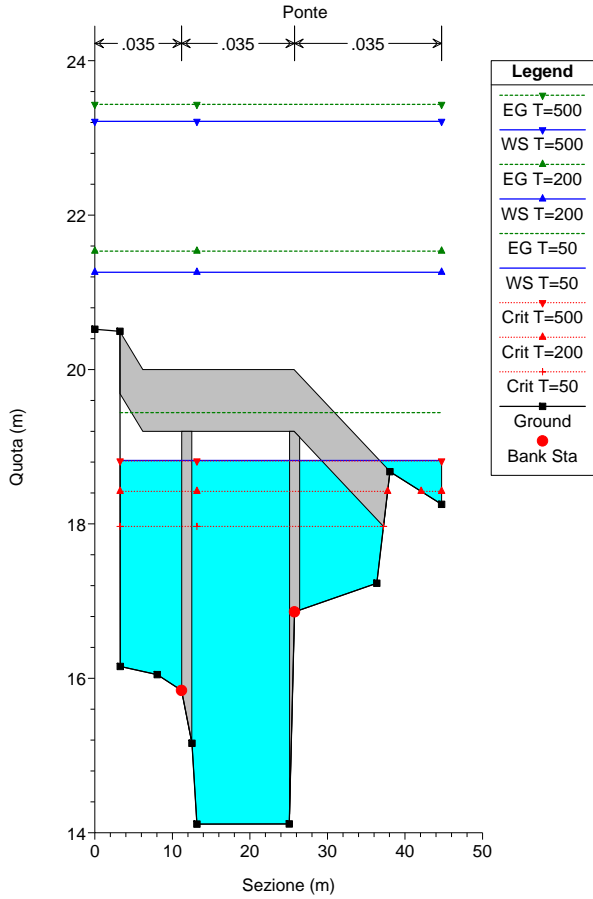

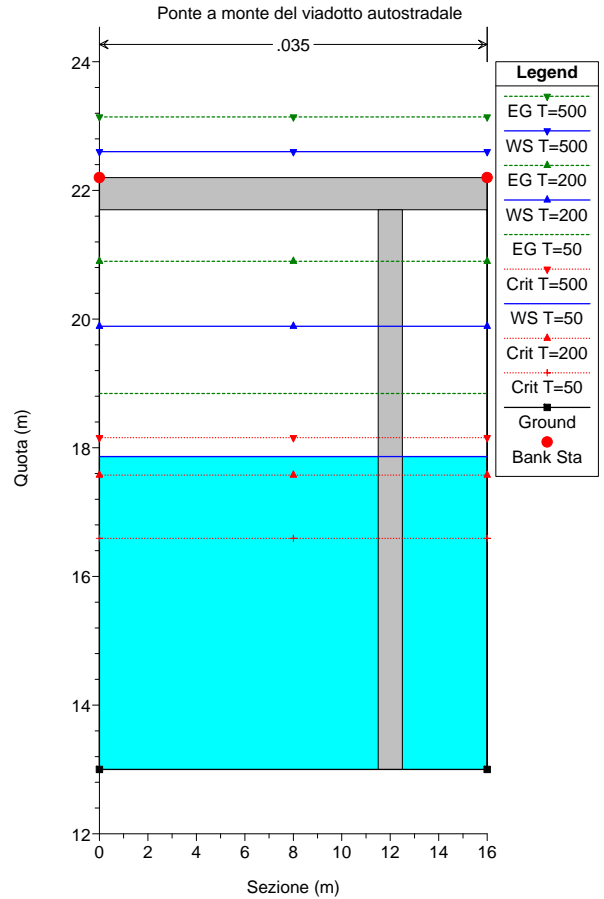
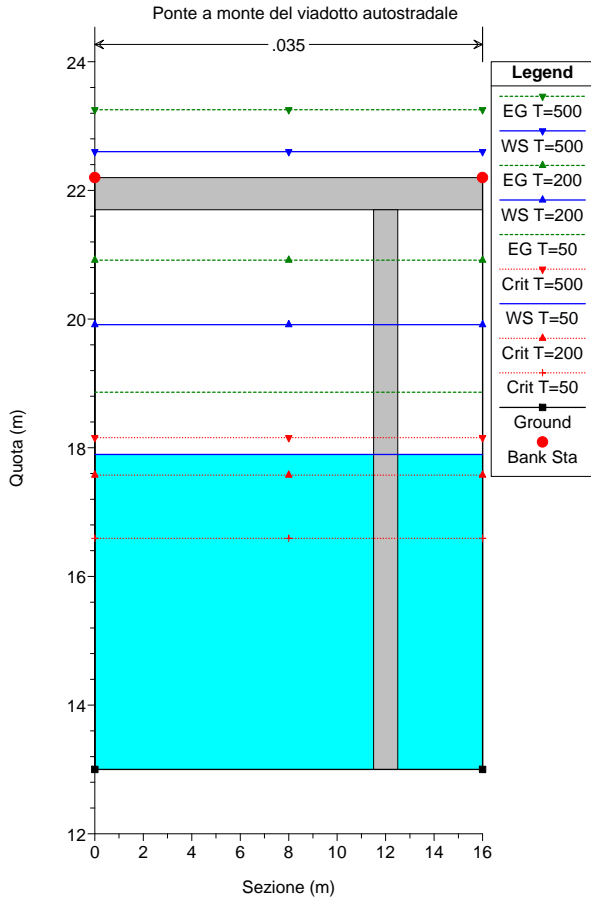
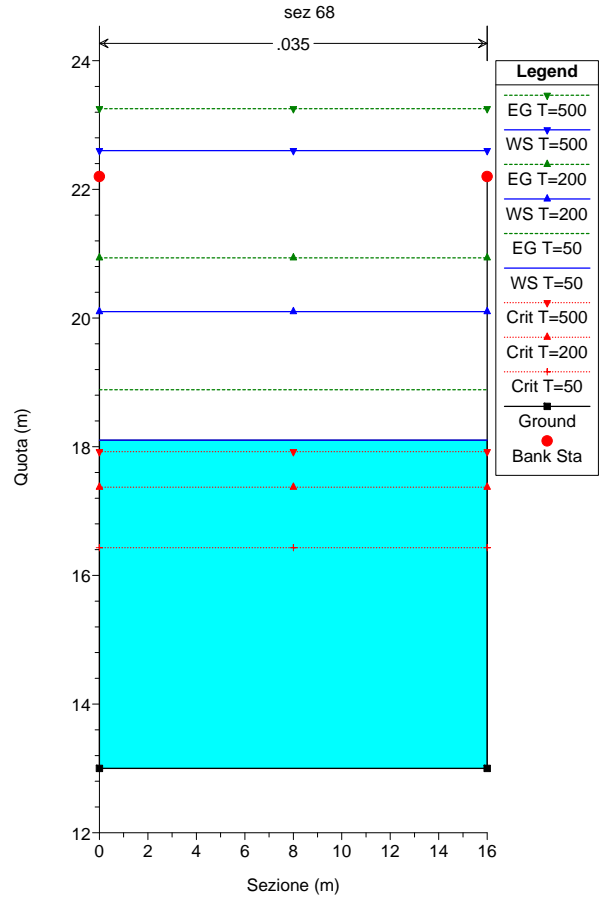
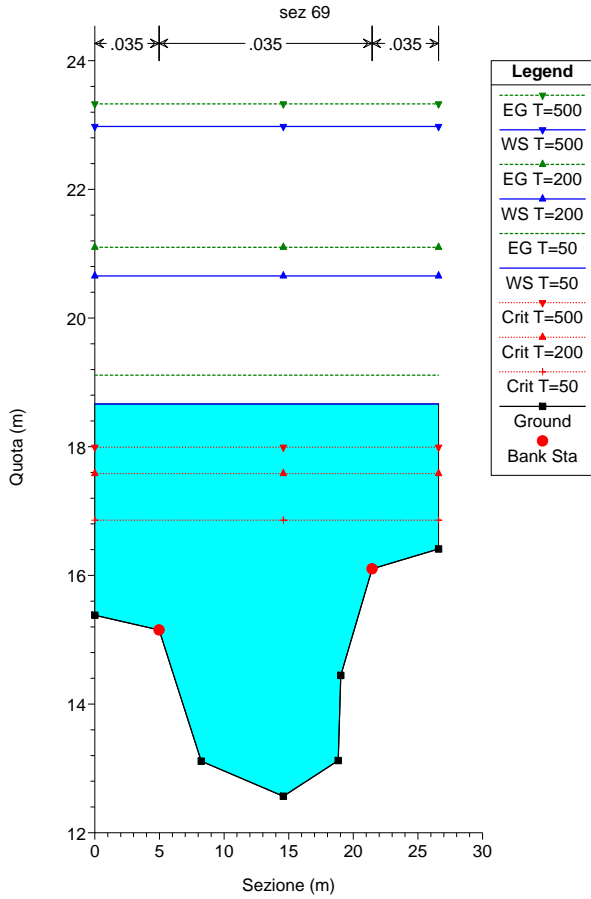

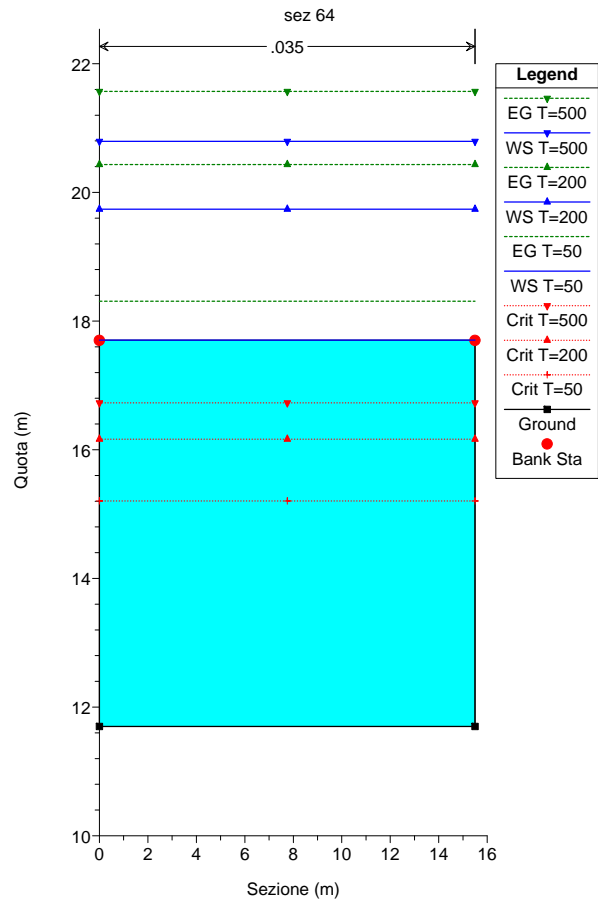
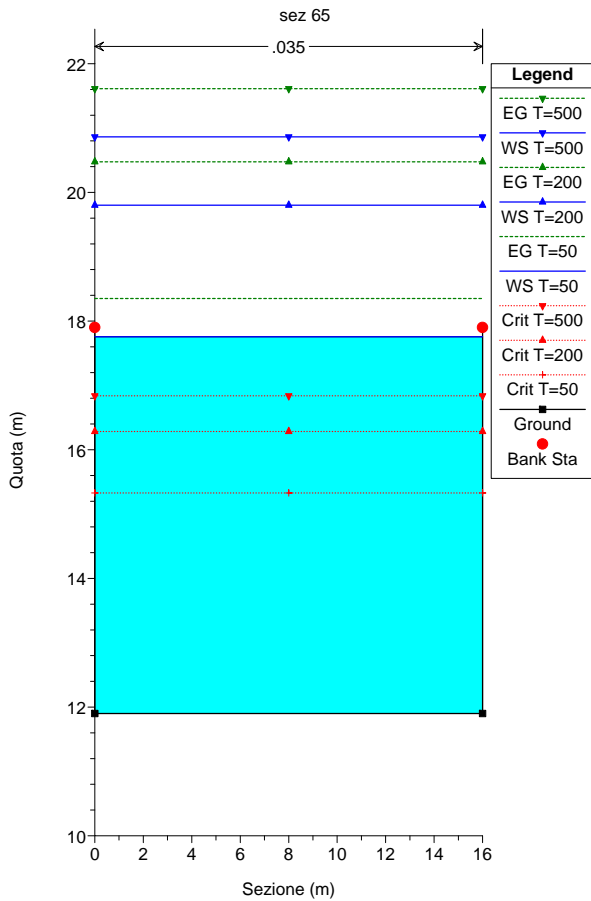
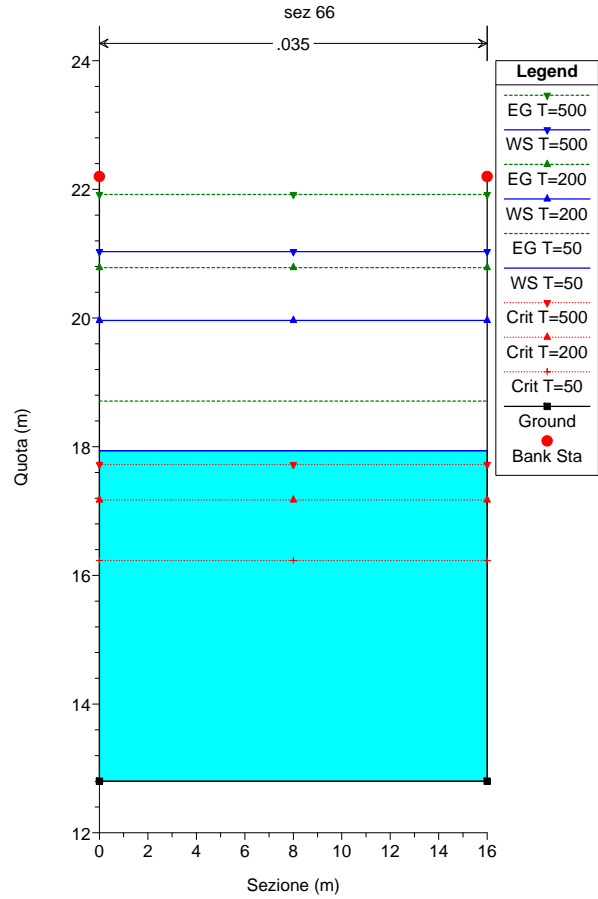
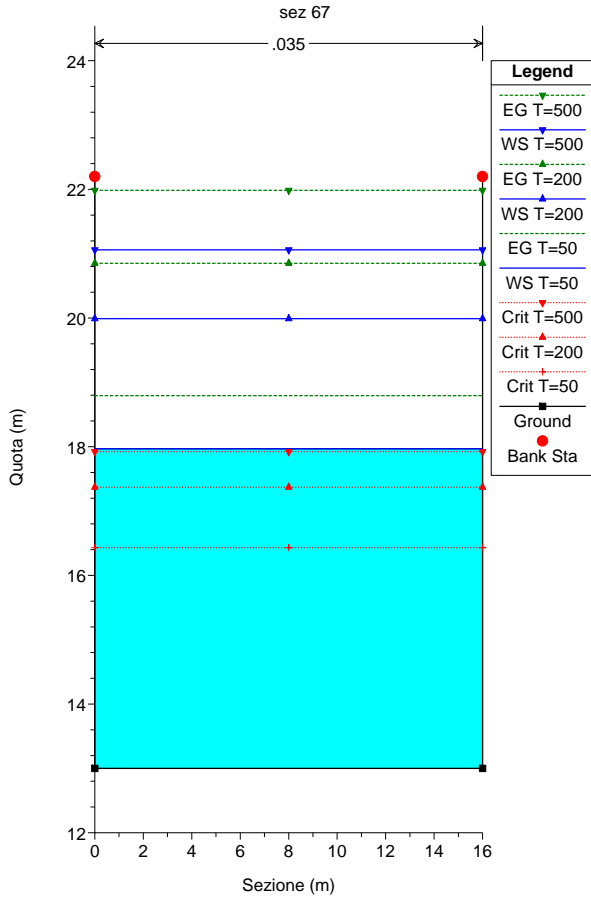

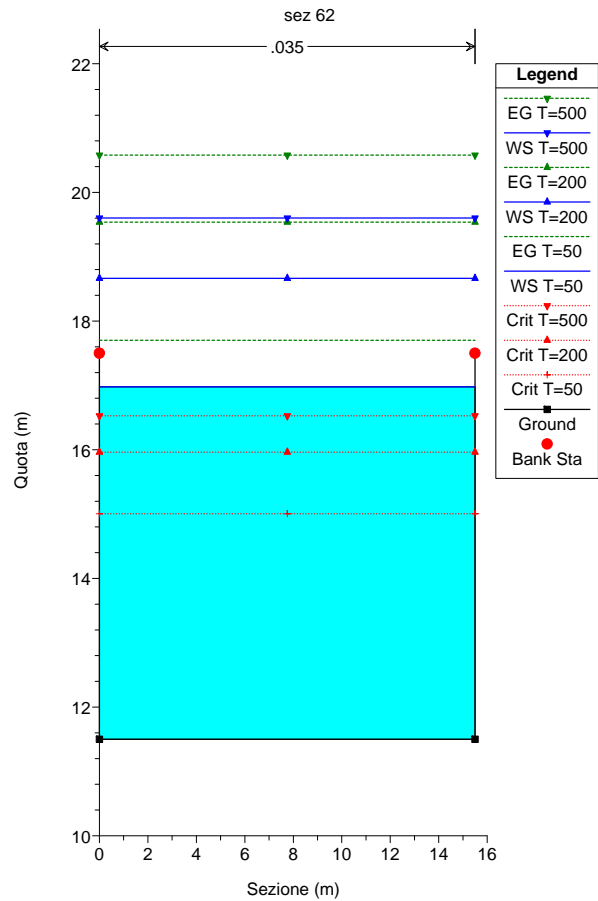
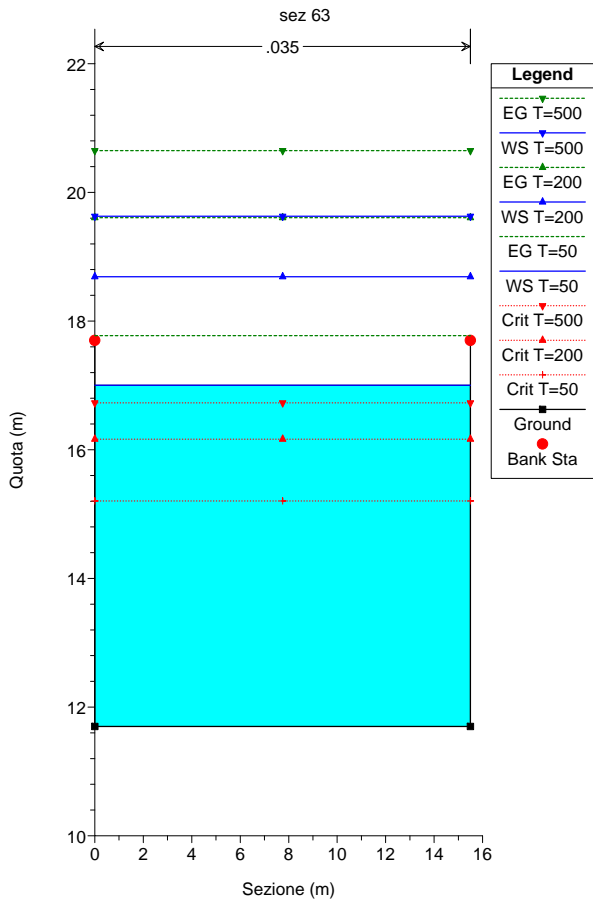
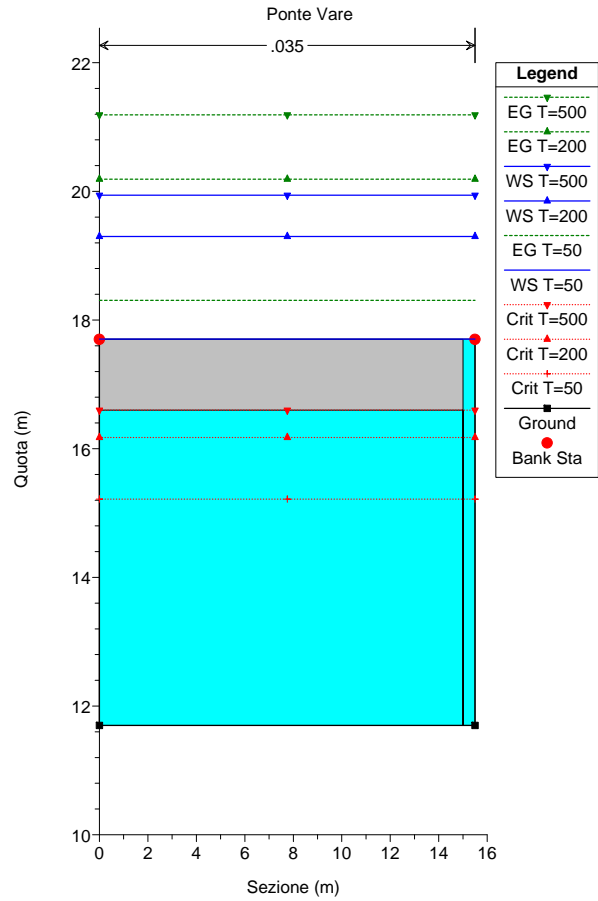
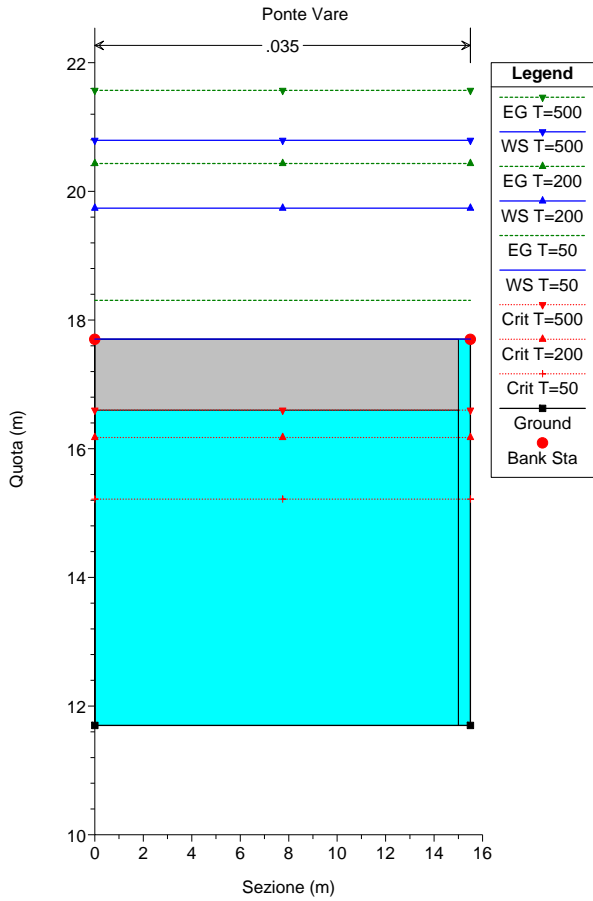

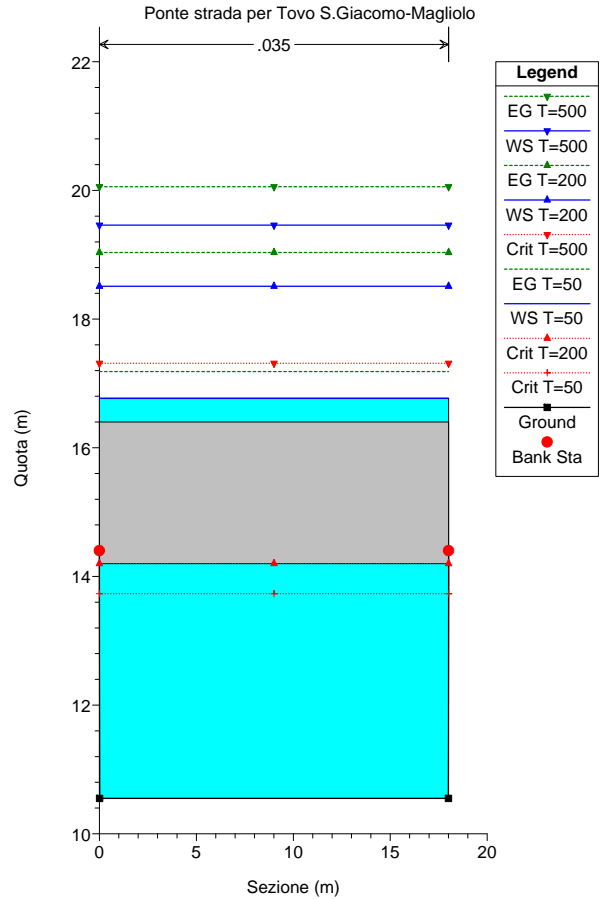
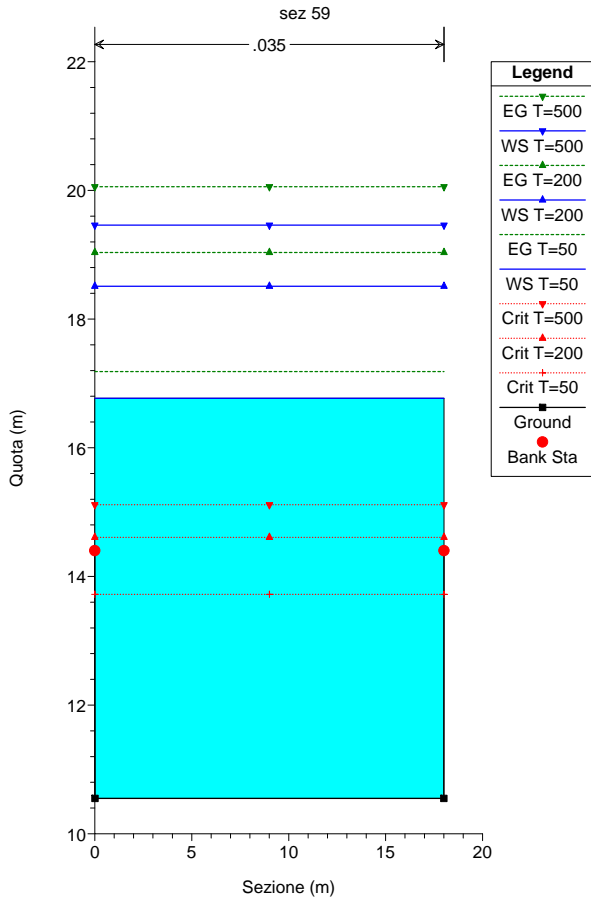
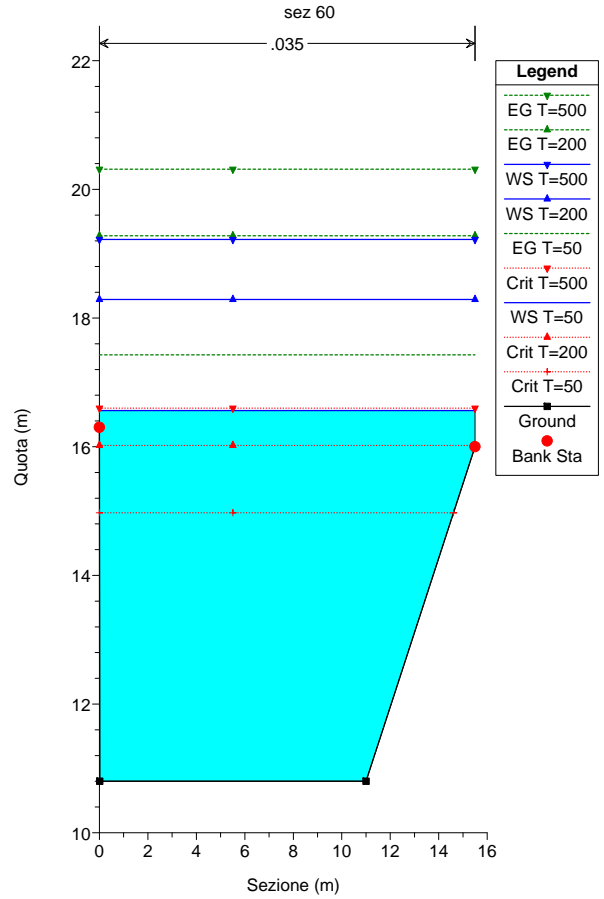
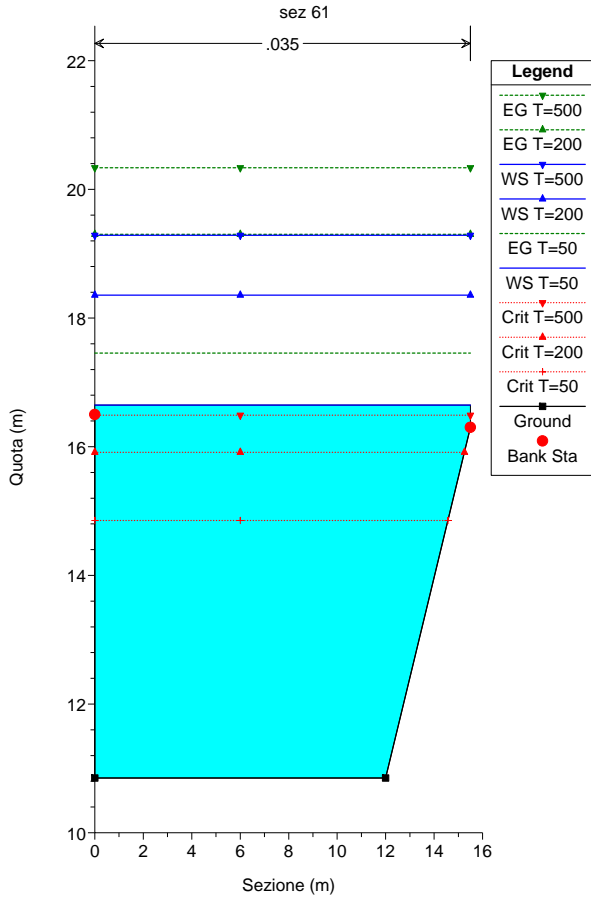

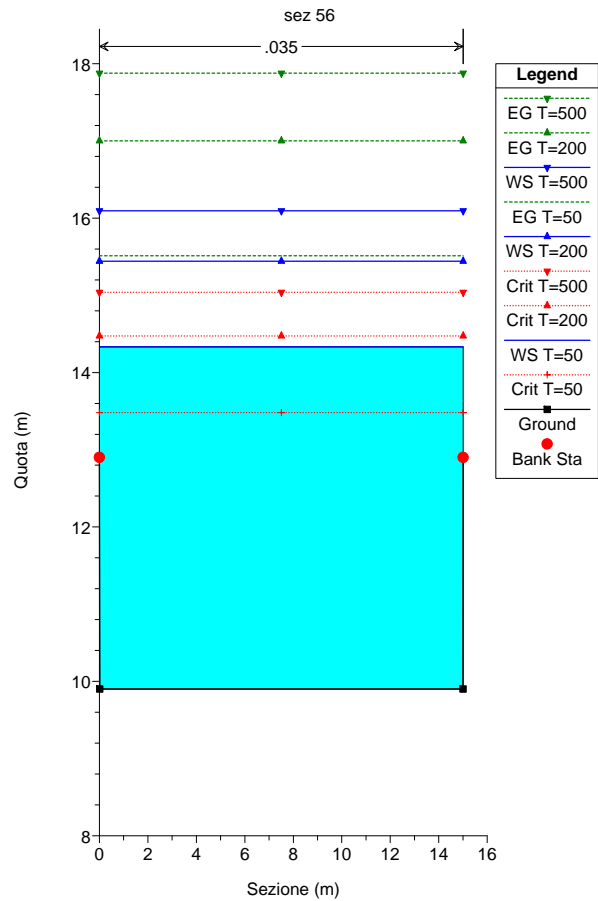
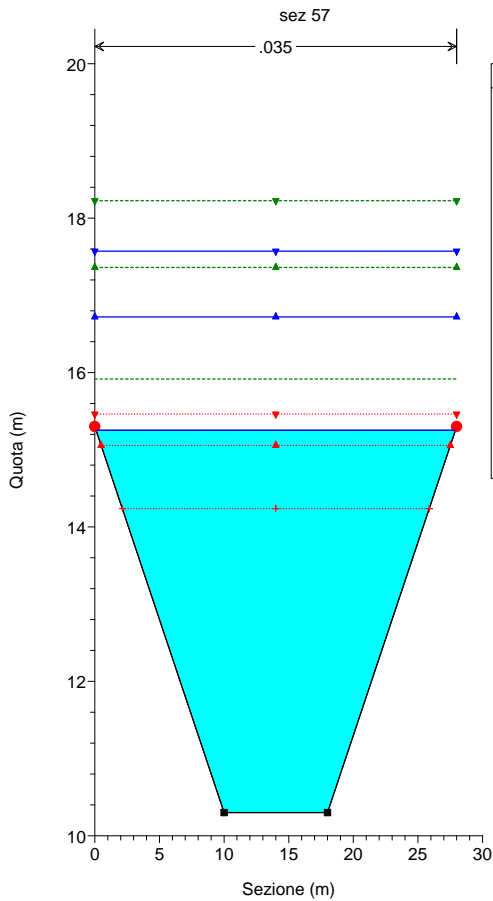
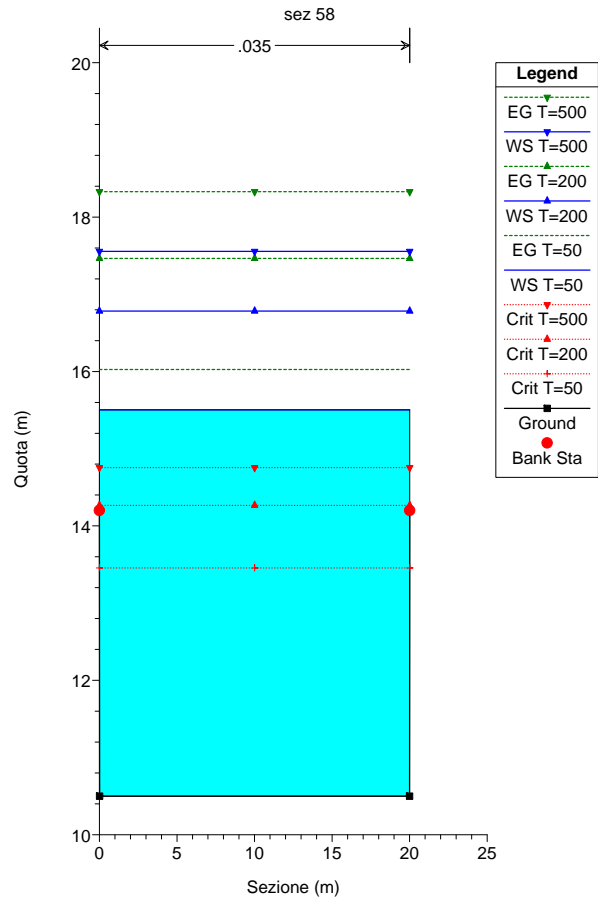
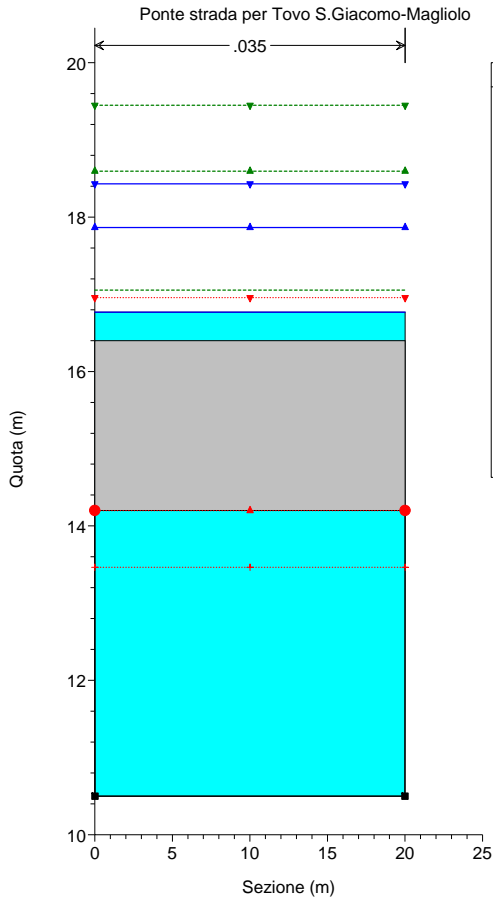

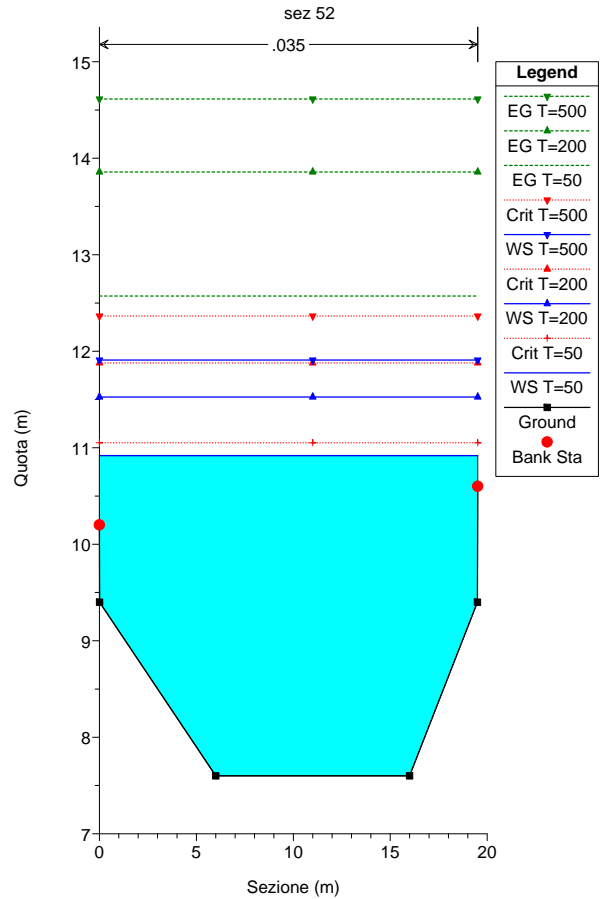
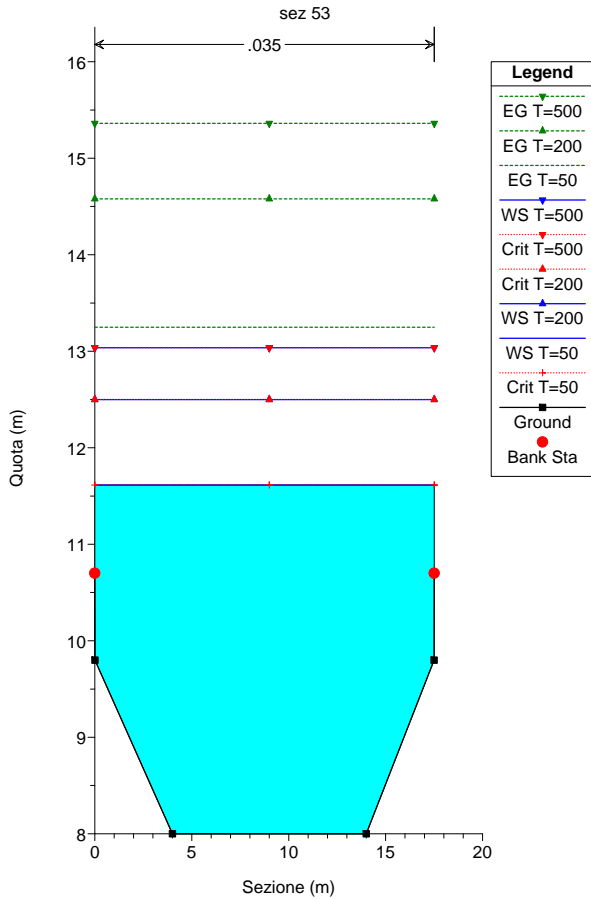
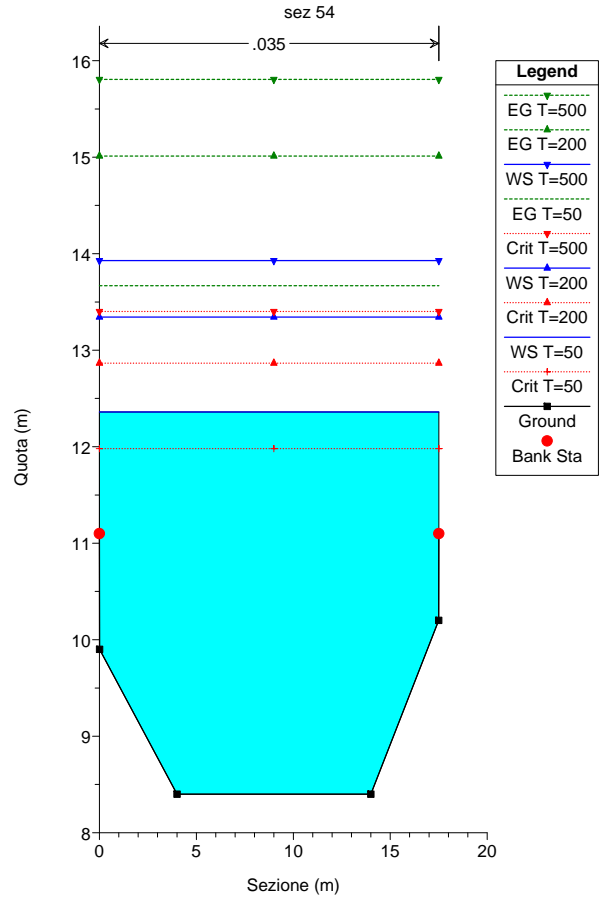
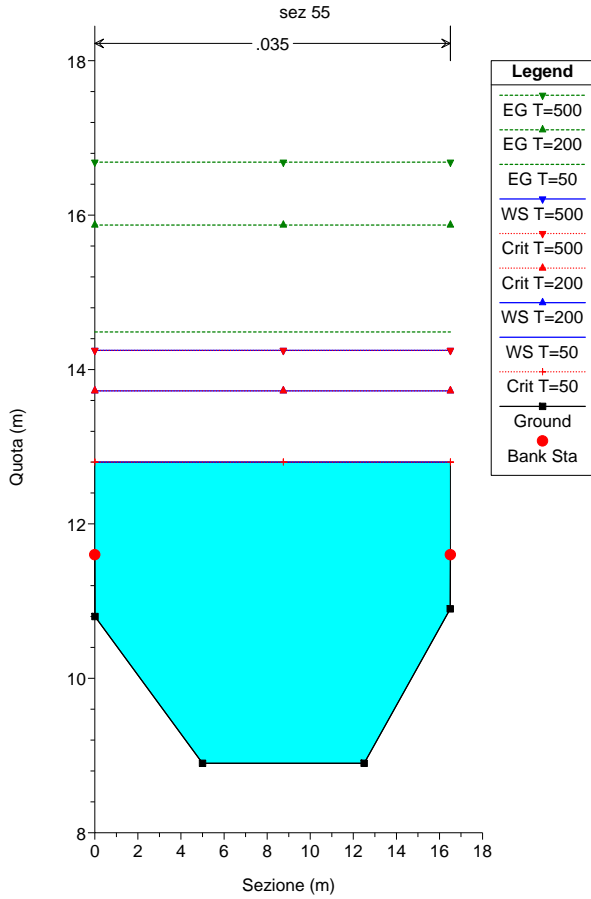

HEC-RAS Plan: attuale_sett_17 River: Maremola Reach: Tovo

Reach	River Sta	Profile	Q Total (m3/s)	Min Ch El (m)	W.S. Elev (m)	LOB Elev (m)	L. Freeboard (m)	ROB Elev (m)	R. Freeboard (m)	Crit W.S. (m)	E.G. Elev (m)	E.G. Slope (m/m)	Vel Chnl (m/s)	Flow Area (m2)	Top Width (m)	Froude # Chl
Tovo	91	T=50	320.00	35.70	40.10	40.00	-0.10	40.00	-0.10	40.10	42.33	0.016238	6.61	48.43	11.00	1.01
Tovo	91	T=200	460.00	35.70	41.31	40.00	-1.31	40.00	-1.31	41.33	44.14	0.017441	7.45	61.70	11.00	1.00
Tovo	91	T=500	550.00	35.70	42.04	40.00	-2.04	40.00	-2.04	42.04	45.21	0.018078	7.89	69.70	11.00	1.00
Tovo	90	T=50	320.00	30.70	37.39	34.90	-2.49	34.90	-2.49	33.66	37.68	0.001100	2.39	133.82	20.00	0.30
Tovo	90	T=200	460.00	30.70	39.51	34.90	-4.61	34.90	-4.61	34.46	39.86	0.001064	2.61	176.26	20.00	0.28
Tovo	90	T=500	550.00	30.70	40.75	34.90	-5.85	34.90	-5.85	34.94	41.13	0.001070	2.74	200.97	20.00	0.28
Tovo	89	T=50	320.00	30.00	36.58	34.20	-2.38	34.20	-2.38	34.41	37.58	0.005544	4.42	72.38	11.00	0.55
Tovo	89	T=200	460.00	30.00	38.50	34.20	-4.30	34.20	-4.30	35.63	39.74	0.005937	4.92	93.52	11.00	0.54
Tovo	89	T=500	550.00	30.00	39.61	34.20	-5.41	34.20	-5.41	36.34	40.99	0.006238	5.20	105.76	11.00	0.54
Tovo	88.5	Bridge														
Tovo	88	T=50	320.00	30.00	34.42	34.20	-0.22	34.20	-0.22	34.42	36.63	0.016088	6.59	48.59	11.00	1.00
Tovo	88	T=200	460.00	30.00	35.61	34.20	-1.41	34.20	-1.41	35.61	38.44	0.017448	7.46	61.70	11.00	1.00
Tovo	88	T=500	550.00	30.00	36.34	34.20	-2.14	34.20	-2.14	36.34	39.51	0.018062	7.89	69.72	11.00	1.00
Tovo	87	T=50	320.00	29.30	31.59	33.50	1.91	33.50	1.91	32.88	36.02	0.050397	9.33	34.32	15.00	1.97
Tovo	87	T=200	460.00	29.30	32.25	33.50	1.25	33.50	1.25	33.87	37.76	0.048822	10.40	44.21	15.00	1.93
Tovo	87	T=500	550.00	29.30	32.64	33.50	0.86	33.50	0.86	34.44	38.79	0.048520	10.99	50.03	15.00	1.92
Tovo	86	T=50	320.00	29.00	30.65	36.40	5.75	36.40	5.75	31.86	35.01	0.065406	9.25	34.60	21.00	2.30
Tovo	86	T=200	460.00	29.00	31.06	36.40	5.34	36.40	5.34	32.64	36.81	0.066797	10.62	43.32	21.00	2.36
Tovo	86	T=500	550.00	29.00	31.31	36.40	5.09	36.40	5.09	33.12	37.84	0.066808	11.32	48.61	21.00	2.37
Tovo	85.5	Bridge														
Tovo	85	T=50	320.00	29.00	30.87	36.40	5.53	36.40	5.53	31.86	34.25	0.043971	8.15	39.26	21.00	1.90
Tovo	85	T=200	460.00	29.00	31.27	36.40	5.13	36.40	5.13	32.65	36.01	0.049540	9.64	47.70	21.00	2.04
Tovo	85	T=500	550.00	29.00	31.52	36.40	4.88	36.40	4.88	33.11	37.03	0.051473	10.40	52.90	21.00	2.09
Tovo	84	T=50	320.00	24.92	27.29	28.60	1.31	25.75	-1.53	27.81	29.42	0.021574	6.73	51.52	28.16	1.41
Tovo	84	T=200	460.00	24.92	27.76	28.60	0.84	25.75	-2.01	28.65	30.49	0.022555	7.66	64.79	28.24	1.46
Tovo	84	T=500	550.00	24.92	28.04	28.60	0.56	25.75	-2.29	28.99	31.13	0.023072	8.19	73.44	34.39	1.49
Tovo	83	T=50	320.00	23.41	26.03	28.60	2.57	25.75	-0.28	27.17	29.28	0.035270	7.99	40.34	20.29	1.71
Tovo	83	T=200	460.00	23.41	26.72	28.60	1.88	25.75	-0.96	27.70	30.37	0.029547	8.56	56.26	26.15	1.60
Tovo	83	T=500	550.00	23.41	29.70	28.60	-1.10	25.75	-3.94	28.39	30.41	0.002787	4.00	155.16	37.08	0.53
Tovo	82	T=50	320.00	22.49	28.17	27.90	-0.28	26.42	-1.76	26.34	28.61	0.001957	3.01	115.31	33.92	0.45
Tovo	82	T=200	460.00	22.49	29.13	27.90	-1.23	26.42	-2.71	27.37	29.68	0.001978	3.43	147.85	34.26	0.46
Tovo	82	T=500	550.00	22.49	29.63	27.90	-1.73	26.42	-3.21	27.78	30.29	0.002139	3.78	166.81	47.85	0.49
Tovo	81	T=50	320.00	21.20	27.06	26.46	-0.61	25.21	-1.86	27.06	28.43	0.008450	5.32	66.13	26.06	0.79

HEC-RAS Plan: attuale_sett_17 River: Maremola Reach: Tovo (Continued)

Reach	River Sta	Profile	Q Total (m3/s)	Min Ch El (m)	W.S. Elev (m)	LOB Elev (m)	L. Freeboard (m)	ROB Elev (m)	R. Freeboard (m)	Crit W.S. (m)	E.G. Elev (m)	E.G. Slope (m/m)	Vel Chnl (m/s)	Flow Area (m2)	Top Width (m)	Froude # Chl
Tovo	81	T=200	460.00	21.20	27.92	26.46	-1.47	25.21	-2.72	27.92	29.48	0.008600	5.85	88.71	26.34	0.80
Tovo	81	T=500	550.00	21.20	28.34	26.46	-1.88	25.21	-3.13	28.34	30.07	0.009052	6.22	99.59	26.34	0.82
Tovo	80	T=50	320.00	19.95	25.61	26.09	0.48	22.75	-2.86	24.44	26.05	0.002154	3.18	115.93	41.05	0.46
Tovo	80	T=200	460.00	19.95	26.66	26.09	-0.57	22.75	-3.91	25.01	27.13	0.001882	3.33	159.34	41.64	0.44
Tovo	80	T=500	550.00	19.95	27.27	26.09	-1.18	22.75	-4.51	25.51	27.77	0.001755	3.44	184.56	41.74	0.43
Tovo	79	T=50	320.00	18.80	23.62	23.07	-0.55	25.61	1.98	23.71	25.16	0.010133	5.66	61.15	21.45	0.94
Tovo	79	T=200	460.00	18.80	24.37	23.07	-1.30	25.61	1.24	24.51	26.33	0.010930	6.47	77.14	21.46	0.98
Tovo	79	T=500	550.00	18.80	24.92	23.07	-1.85	25.61	0.68	24.96	27.01	0.010407	6.70	89.02	21.47	0.96
Tovo	78	T=50	320.00	18.90	22.56	22.59	0.03	22.49	-0.07	23.16	24.63	0.016976	6.51	53.22	31.33	1.25
Tovo	78	T=200	460.00	18.90	23.02	22.59	-0.43	22.49	-0.53	23.82	25.74	0.018943	7.61	67.70	31.55	1.35
Tovo	78	T=500	550.00	18.90	23.27	22.59	-0.68	22.49	-0.78	24.11	26.39	0.019921	8.21	75.67	31.56	1.41
Tovo	77	T=50	320.00	17.90	22.46	22.61	0.15	22.07	-0.39	21.24	22.95	0.002747	3.15	106.35	38.80	0.53
Tovo	77	T=200	460.00	17.90	23.69	22.61	-1.08	22.07	-1.62	22.07	24.17	0.001969	3.16	155.57	40.40	0.46
Tovo	77	T=500	550.00	17.90	24.40	22.61	-1.80	22.07	-2.34	22.42	24.89	0.001710	3.19	184.62	40.58	0.44
Tovo	76	T=50	320.00	16.95	22.09	22.29	0.20	20.35	-1.74	21.33	22.71	0.003726	3.75	94.99	30.09	0.58
Tovo	76	T=200	460.00	16.95	23.43	22.29	-1.13	20.35	-3.08	21.96	24.02	0.002518	3.68	140.28	34.85	0.50
Tovo	76	T=500	550.00	16.95	24.16	22.29	-1.87	20.35	-3.81	22.29	24.76	0.002192	3.73	165.87	34.85	0.48
Tovo	75	T=50	320.00	15.75	20.62	22.46	1.84	19.52	-1.10	20.62	22.28	0.009695	5.78	57.93	17.81	0.93
Tovo	75	T=200	460.00	15.75	21.52	22.46	0.94	19.52	-2.00	21.52	23.62	0.010137	6.57	73.93	17.86	0.96
Tovo	75	T=500	550.00	15.75	22.04	22.46	0.42	19.52	-2.52	22.04	24.41	0.010374	6.99	83.28	17.89	0.97
Tovo	74	T=50	320.00	15.72	18.16	18.65	0.49	19.54	1.38	18.95	20.53	0.024275	6.82	46.94	22.34	1.50
Tovo	74	T=200	460.00	15.72	21.24	18.65	-2.59	19.54	-1.70	19.75	21.78	0.001991	3.41	149.25	37.34	0.48
Tovo	74	T=500	550.00	15.72	23.21	18.65	-4.56	19.54	-3.67	20.13	23.56	0.000878	2.82	230.82	48.32	0.34
Tovo	73	T=50	320.00	14.77	19.36	22.85	3.49	19.30	-0.07	17.89	19.81	0.002302	2.97	110.03	43.19	0.49
Tovo	73	T=200	460.00	14.77	21.34	22.85	1.51	19.30	-2.05	18.56	21.65	0.001021	2.53	195.58	43.27	0.34
Tovo	73	T=500	550.00	14.77	23.28	22.85	-0.43	19.30	-3.98	18.96	23.49	0.000507	2.11	283.91	51.56	0.24
Tovo	72	T=50	320.00	14.11	19.01	15.84	-3.17	16.86	-2.15	17.87	19.46	0.002184	3.31	117.90	41.46	0.49
Tovo	72	T=200	460.00	14.11	21.26	15.84	-5.42	16.86	-4.40	18.52	21.53	0.000840	2.67	213.75	44.72	0.32
Tovo	72	T=500	550.00	14.11	23.25	15.84	-7.41	16.86	-6.39	19.00	23.44	0.000424	2.24	302.64	44.72	0.24
Tovo	71.5		Bridge													
Tovo	71	T=50	320.00	14.02	18.90	15.80	-3.10	16.86	-2.04	17.86	19.39	0.002416	3.43	113.53	41.46	0.51
Tovo	71	T=200	460.00	14.02	20.94	15.80	-5.14	16.86	-4.08	18.50	21.26	0.001025	2.86	199.76	44.72	0.35
Tovo	71	T=500	550.00	14.02	23.23	15.80	-7.43	16.86	-6.37	18.63	23.42	0.000426	2.25	302.01	44.72	0.24

HEC-RAS Plan: attuale_sett_17 River: Maremola Reach: Tovo (Continued)

Reach	River Sta	Profile	Q Total (m3/s)	Min Ch El (m)	W.S. Elev (m)	LOB Elev (m)	L. Freeboard (m)	ROB Elev (m)	R. Freeboard (m)	Crit W.S. (m)	E.G. Elev (m)	E.G. Slope (m/m)	Vel Chnl (m/s)	Flow Area (m2)	Top Width (m)	Froude # Chl
Tovo	70	T=50	320.00	12.78	18.67	15.45	-3.22	16.40	-2.27	17.15	19.18	0.001948	3.35	107.53	26.59	0.48
Tovo	70	T=200	460.00	12.78	20.66	15.45	-5.21	16.40	-4.26	17.86	21.15	0.001208	3.31	160.37	26.59	0.40
Tovo	70	T=500	550.00	12.78	22.98	15.45	-7.53	16.40	-6.58	18.27	23.35	0.000645	2.93	222.03	26.59	0.31
Tovo	69	T=50	320.00	12.57	18.66	15.15	-3.51	16.10	-2.56	16.86	19.11	0.001597	3.14	114.93	26.59	0.44
Tovo	69	T=200	460.00	12.57	20.65	15.15	-5.50	16.10	-4.55	17.58	21.10	0.001054	3.17	167.87	26.59	0.38
Tovo	69	T=500	550.00	12.57	22.98	15.15	-7.82	16.10	-6.88	17.99	23.33	0.000584	2.84	229.61	26.59	0.29
Tovo	68	T=50	320.00	13.00	18.10	22.20	4.10	22.20	4.10	16.43	18.88	0.004137	3.92	81.63	16.00	0.55
Tovo	68	T=200	460.00	13.00	20.10	22.20	2.10	22.20	2.10	17.37	20.94	0.003434	4.05	113.60	16.00	0.49
Tovo	68	T=500	550.00	13.00	22.60	22.20	-0.40	22.20	-0.40	17.92	23.25	0.002202	3.58	153.62	16.00	0.37
Tovo	67.5		Bridge													
Tovo	67	T=50	320.00	13.00	17.97	22.20	4.23	22.20	4.23	16.43	18.79	0.004460	4.03	79.49	16.00	0.58
Tovo	67	T=200	460.00	13.00	19.99	22.20	2.21	22.20	2.21	17.37	20.85	0.003583	4.11	111.83	16.00	0.50
Tovo	67	T=500	550.00	13.00	21.06	22.20	1.14	22.20	1.14	17.92	21.99	0.003492	4.27	128.95	16.00	0.48
Tovo	66	T=50	320.00	12.80	17.94	22.20	4.26	22.20	4.26	16.23	18.71	0.004058	3.89	82.20	16.00	0.55
Tovo	66	T=200	460.00	12.80	19.96	22.20	2.24	22.20	2.24	17.17	20.78	0.003353	4.01	114.60	16.00	0.48
Tovo	66	T=500	550.00	12.80	21.03	22.20	1.17	22.20	1.17	17.72	21.92	0.003301	4.18	131.71	16.00	0.46
Tovo	65	T=50	320.00	11.90	17.76	17.90	0.14	17.90	0.14	15.33	18.35	0.002816	3.42	93.70	16.00	0.45
Tovo	65	T=200	460.00	11.90	19.80	17.90	-1.90	17.90	-1.90	16.28	20.47	0.002577	3.64	126.40	16.00	0.41
Tovo	65	T=500	550.00	11.90	20.86	17.90	-2.96	17.90	-2.96	16.84	21.61	0.002636	3.84	143.42	16.00	0.41
Tovo	64	T=50	320.00	11.70	17.70	17.70	0.00	17.70	0.00	15.20	18.31	0.002851	3.44	93.07	15.50	0.45
Tovo	64	T=200	460.00	11.70	19.74	17.70	-2.04	17.70	-2.04	16.16	20.43	0.002678	3.69	124.60	15.50	0.42
Tovo	64	T=500	550.00	11.70	20.79	17.70	-3.09	17.70	-3.09	16.73	21.57	0.002766	3.90	140.96	15.50	0.41
Tovo	63.5		Bridge													
Tovo	63	T=50	320.00	11.70	17.00	17.70	0.70	17.70	0.70	15.20	17.77	0.004026	3.89	82.17	15.50	0.54
Tovo	63	T=200	460.00	11.70	18.69	17.70	-0.99	17.70	-0.99	16.16	19.61	0.003894	4.25	108.34	15.50	0.51
Tovo	63	T=500	550.00	11.70	19.63	17.70	-1.93	17.70	-1.93	16.73	20.65	0.003969	4.47	122.91	15.50	0.51
Tovo	62	T=50	320.00	11.50	16.98	17.50	0.52	17.50	0.52	15.00	17.70	0.003675	3.77	84.91	15.50	0.51
Tovo	62	T=200	460.00	11.50	18.66	17.50	-1.16	17.50	-1.16	15.96	19.54	0.003644	4.14	111.04	15.50	0.49
Tovo	62	T=500	550.00	11.50	19.60	17.50	-2.10	17.50	-2.10	16.53	20.58	0.003749	4.38	125.58	15.50	0.49
Tovo	61	T=50	320.00	10.85	16.65	16.50	-0.15	16.30	-0.35	14.85	17.46	0.004021	3.98	80.30	15.50	0.56
Tovo	61	T=200	460.00	10.85	18.35	16.50	-1.85	16.30	-2.05	15.91	19.30	0.003821	4.31	106.79	15.50	0.52
Tovo	61	T=500	550.00	10.85	19.29	16.50	-2.79	16.30	-2.99	16.49	20.34	0.003900	4.54	121.23	15.50	0.52
Tovo	60	T=50	320.00	10.80	16.56	16.30	-0.26	16.00	-0.56	14.97	17.43	0.004408	4.13	77.57	15.50	0.59

HEC-RAS Plan: attuale_sett_17 River: Maremola Reach: Tovo (Continued)

Reach	River Sta	Profile	Q Total (m3/s)	Min Ch El (m)	W.S. Elev (m)	LOB Elev (m)	L. Freeboard (m)	ROB Elev (m)	R. Freeboard (m)	Crit W.S. (m)	E.G. Elev (m)	E.G. Slope (m/m)	Vel Chnl (m/s)	Flow Area (m2)	Top Width (m)	Froude # Chl
Tovo	60	T=200	460.00	10.80	18.29	16.30	-1.99	16.00	-2.29	16.02	19.28	0.004052	4.41	104.34	15.50	0.54
Tovo	60	T=500	550.00	10.80	19.22	16.30	-2.92	16.00	-3.22	16.60	20.31	0.004100	4.63	118.80	15.50	0.53
Tovo	59	T=50	320.00	10.55	16.77	14.40	-2.37	14.40	-2.37	13.72	17.18	0.001762	2.86	111.95	18.01	0.37
Tovo	59	T=200	460.00	10.55	18.51	14.40	-4.11	14.40	-4.11	14.61	19.03	0.001848	3.21	143.30	18.01	0.36
Tovo	59	T=500	550.00	10.55	19.46	14.40	-5.06	14.40	-5.06	15.11	20.06	0.001950	3.43	160.41	18.01	0.37
Tovo	58.5	Bridge														
Tovo	58	T=50	320.00	10.50	15.50	14.20	-1.30	14.20	-1.30	13.46	16.03	0.002510	3.20	100.10	20.01	0.46
Tovo	58	T=200	460.00	10.50	16.78	14.20	-2.58	14.20	-2.58	14.27	17.47	0.002709	3.66	125.69	20.01	0.47
Tovo	58	T=500	550.00	10.50	17.56	14.20	-3.36	14.20	-3.36	14.76	18.33	0.002799	3.90	141.14	20.01	0.47
Tovo	57	T=50	320.00	10.30	15.25	15.30	0.05	15.30	0.05	14.24	15.92	0.003785	3.61	88.68	27.81	0.65
Tovo	57	T=200	460.00	10.30	16.72	15.30	-1.42	15.30	-1.42	15.06	17.36	0.002499	3.54	129.79	28.00	0.53
Tovo	57	T=500	550.00	10.30	17.57	15.30	-2.27	15.30	-2.27	15.46	18.23	0.002176	3.58	153.65	28.00	0.49
Tovo	56	T=50	320.00	9.90	14.33	12.90	-1.43	12.90	-1.43	13.48	15.51	0.007226	4.81	66.51	15.01	0.73
Tovo	56	T=200	460.00	9.90	15.44	12.90	-2.54	12.90	-2.54	14.47	17.00	0.007983	5.53	83.16	15.01	0.75
Tovo	56	T=500	550.00	9.90	16.10	12.90	-3.20	12.90	-3.20	15.04	17.88	0.008404	5.92	92.96	15.01	0.76
Tovo	55	T=50	320.00	8.90	12.80	11.60	-1.20	11.60	-1.20	12.80	14.49	0.011214	5.75	55.62	16.51	1.00
Tovo	55	T=200	460.00	8.90	13.72	11.60	-2.12	11.60	-2.12	13.72	15.87	0.011563	6.49	70.84	16.51	1.00
Tovo	55	T=500	550.00	8.90	14.25	11.60	-2.65	11.60	-2.65	14.25	16.69	0.011940	6.92	79.51	16.51	1.01
Tovo	54	T=50	320.00	8.40	12.36	11.10	-1.26	11.10	-1.26	11.98	13.67	0.008092	5.07	63.16	17.51	0.85
Tovo	54	T=200	460.00	8.40	13.34	11.10	-2.24	11.10	-2.24	12.87	15.01	0.008364	5.72	80.36	17.51	0.85
Tovo	54	T=500	550.00	8.40	13.93	11.10	-2.83	11.10	-2.83	13.40	15.81	0.008520	6.07	90.62	17.51	0.85
Tovo	53	T=50	320.00	8.00	11.61	10.70	-0.91	10.70	-0.91	11.61	13.25	0.011138	5.66	56.49	17.51	1.01
Tovo	53	T=200	460.00	8.00	12.50	10.70	-1.80	10.70	-1.80	12.50	14.58	0.011369	6.39	72.01	17.51	1.01
Tovo	53	T=500	550.00	8.00	13.04	10.70	-2.34	10.70	-2.34	13.04	15.36	0.011454	6.76	81.41	17.51	1.00
Tovo	52	T=50	320.00	7.60	10.92	10.20	-0.72	10.60	-0.32	11.05	12.57	0.012252	5.70	56.17	19.51	1.07
Tovo	52	T=200	460.00	7.60	11.53	10.20	-1.33	10.60	-0.93	11.88	13.86	0.014326	6.76	68.00	19.51	1.16
Tovo	52	T=500	550.00	7.60	11.91	10.20	-1.71	10.60	-1.31	12.36	14.61	0.015064	7.29	75.49	19.51	1.18
Tovo	51	T=50	320.00	7.10	10.46	9.90	-0.56	11.46	1.00	9.67	11.18	0.004485	3.76	85.18	26.01	0.66
Tovo	51	T=200	460.00	7.10	9.61	9.90	0.29	11.46	1.85	10.35	12.32	0.023452	7.30	63.03	26.00	1.50
Tovo	51	T=500	550.00	7.10	9.87	9.90	0.03	11.46	1.59	10.75	13.04	0.024589	7.90	69.65	26.00	1.54

T. MAREMOLA – tratto intermedio, loc. Tovo San Giacomo

dalla SEZ. **75** (loc. Bringhiera, quota 75 m slm circa)

alla SEZ. **65** (loc. Tovo San Giacomo, quota 35 m slm circa)

- **PROFILI DI RIGURGITO IN CONDIZIONI DI MOTO PERMANENTE PER LE PORTATE $T = 50, 200, 500$ ANNI**

- **GEOMETRIA DELLE SEZIONI ED ALTEZZA DEL PELO LIBERO IN CONDIZIONI DI MOTO PERMANENTE PER LE PORTATE $T = 50, 200, 500$ ANNI**

- **MODELLAZIONE IDRAULICA IN CONDIZIONI DI MOTO PERMANENTE:
TABELLE DELLE GRANDEZZE IDRAULICHE
SIGNIFICATIVE PER LE PORTATE $T = 50, 200, 500$ ANNI**

[m s.m.]

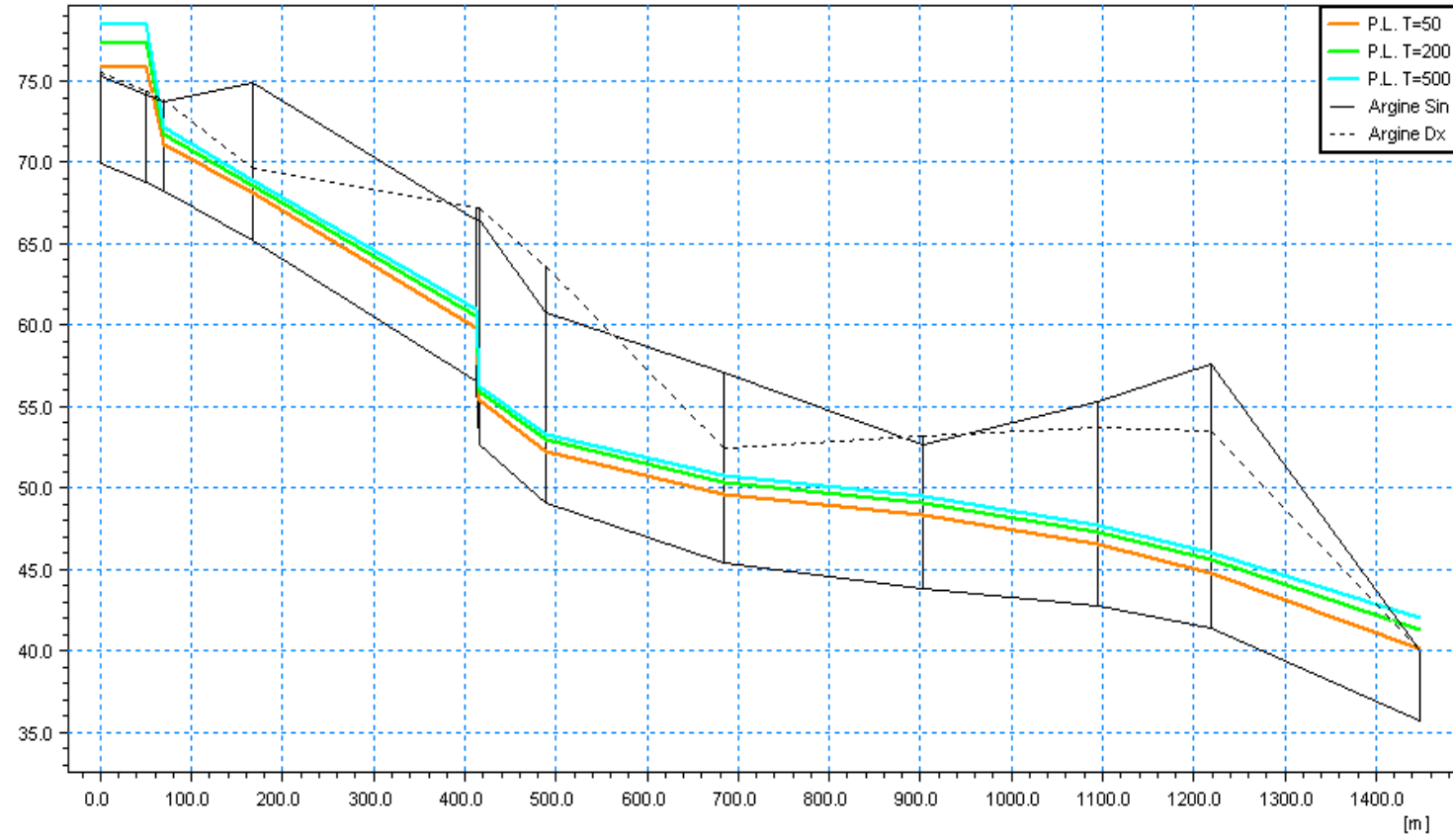

Progressiva	-50.000	0.000	116.920	361.940	438.620	633.790	852.210	1044.330	1168.570	1399.090
ID Sezione	75	73	72	70	69	68	67	66	65	

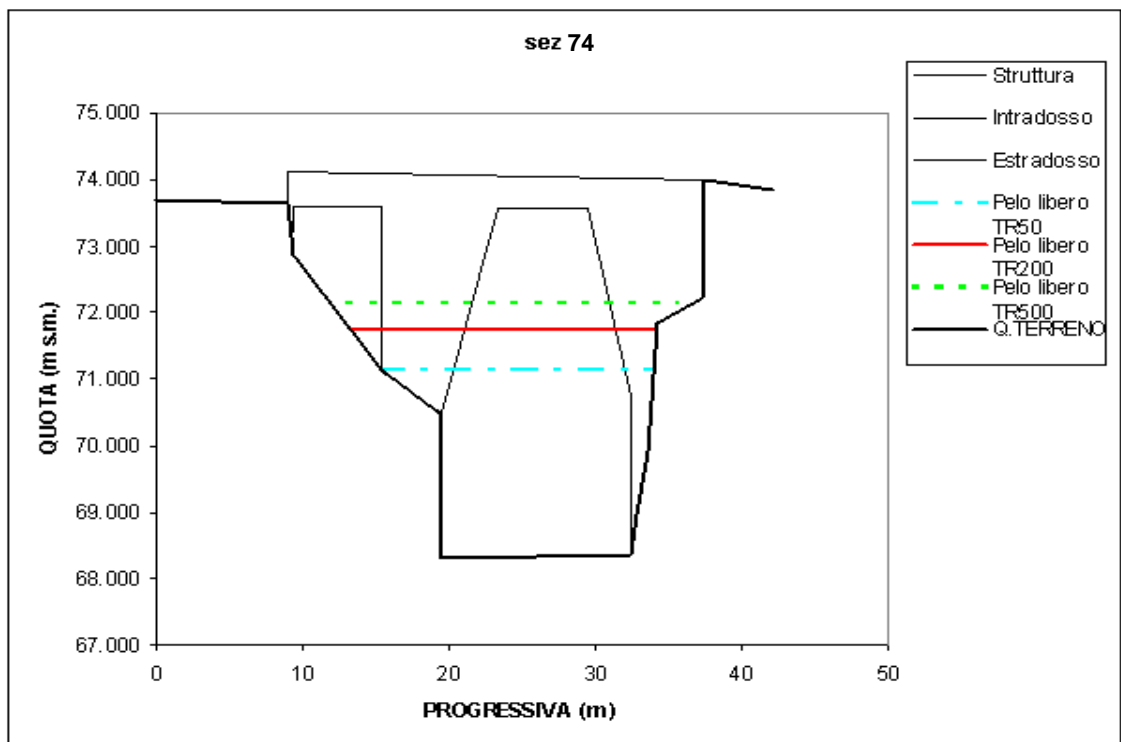
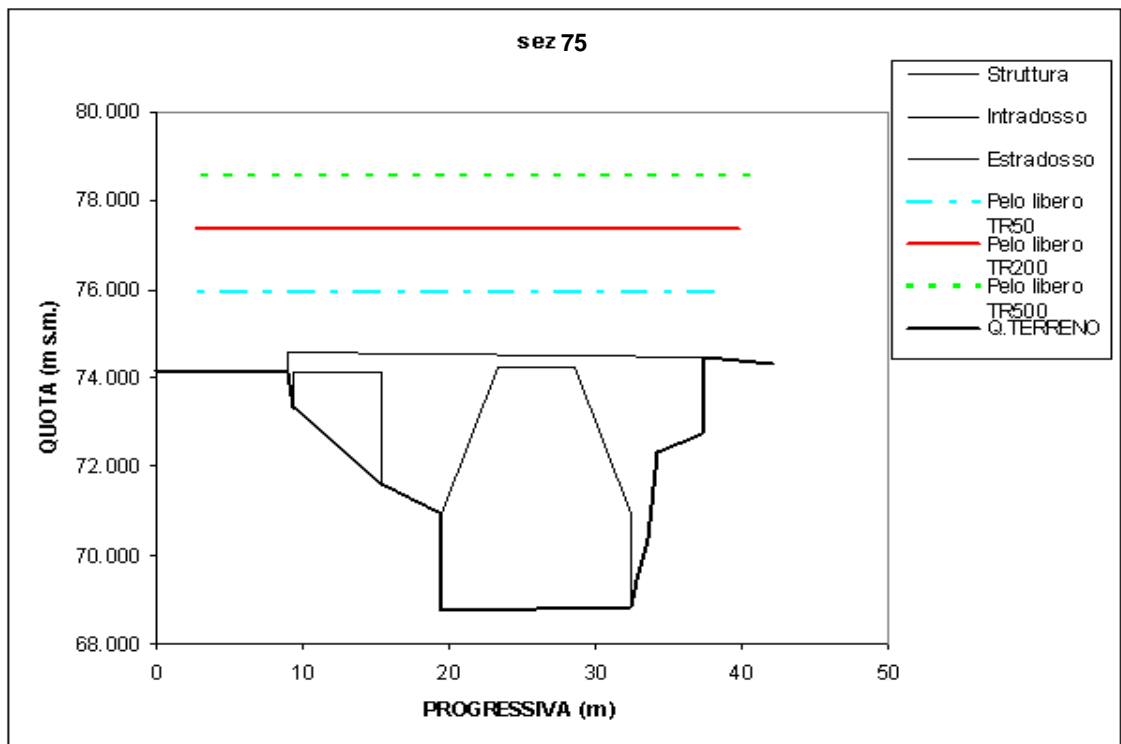

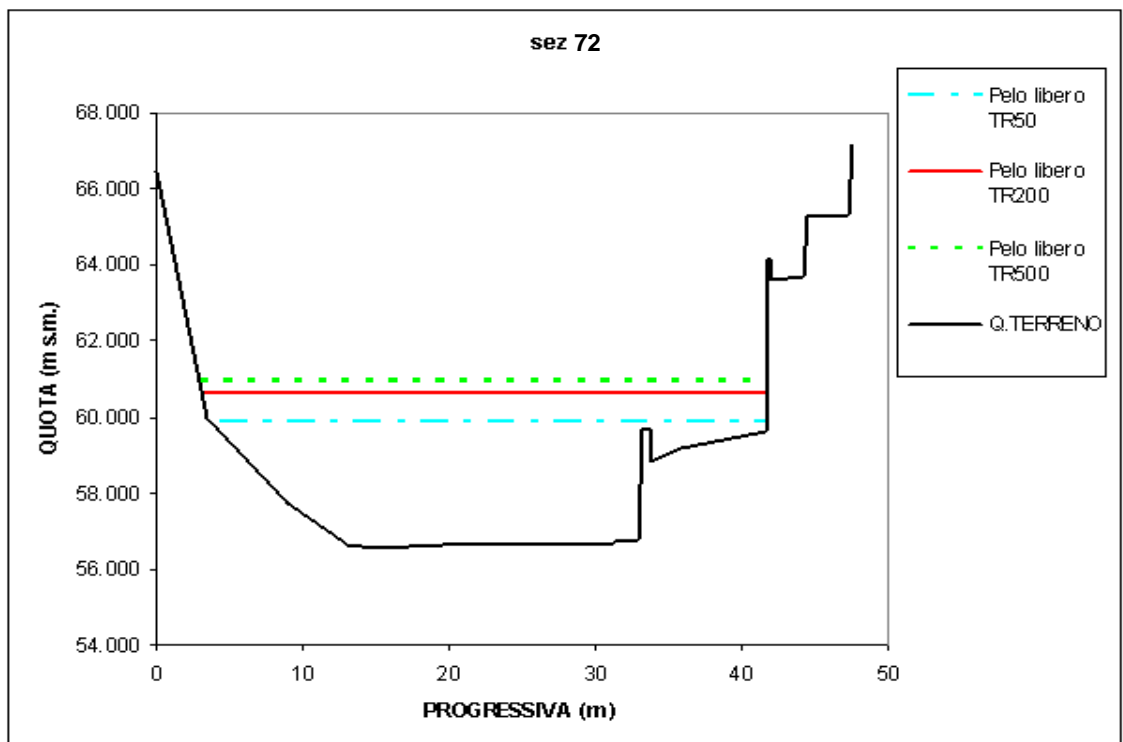
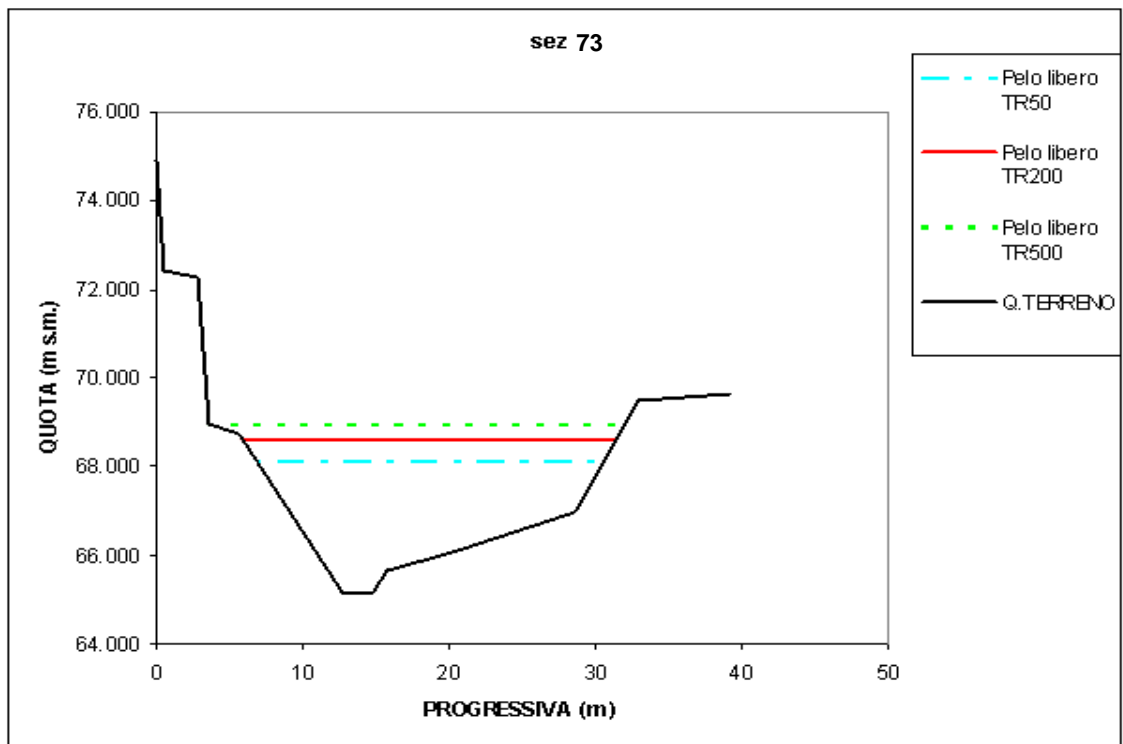

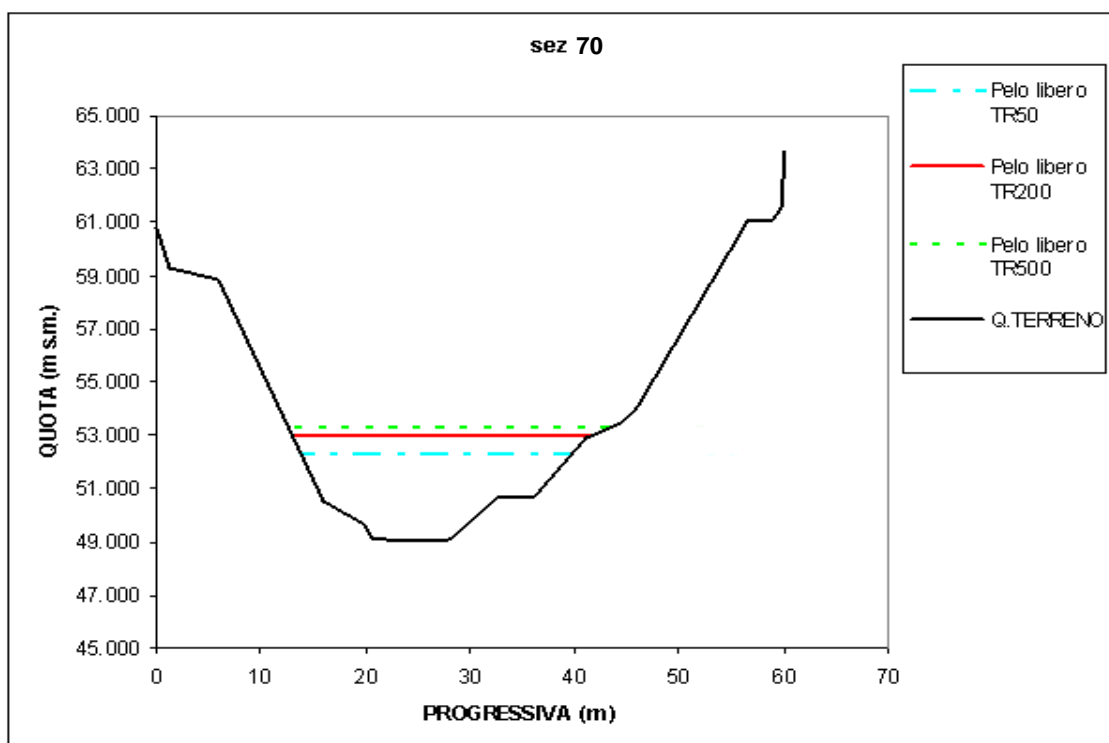
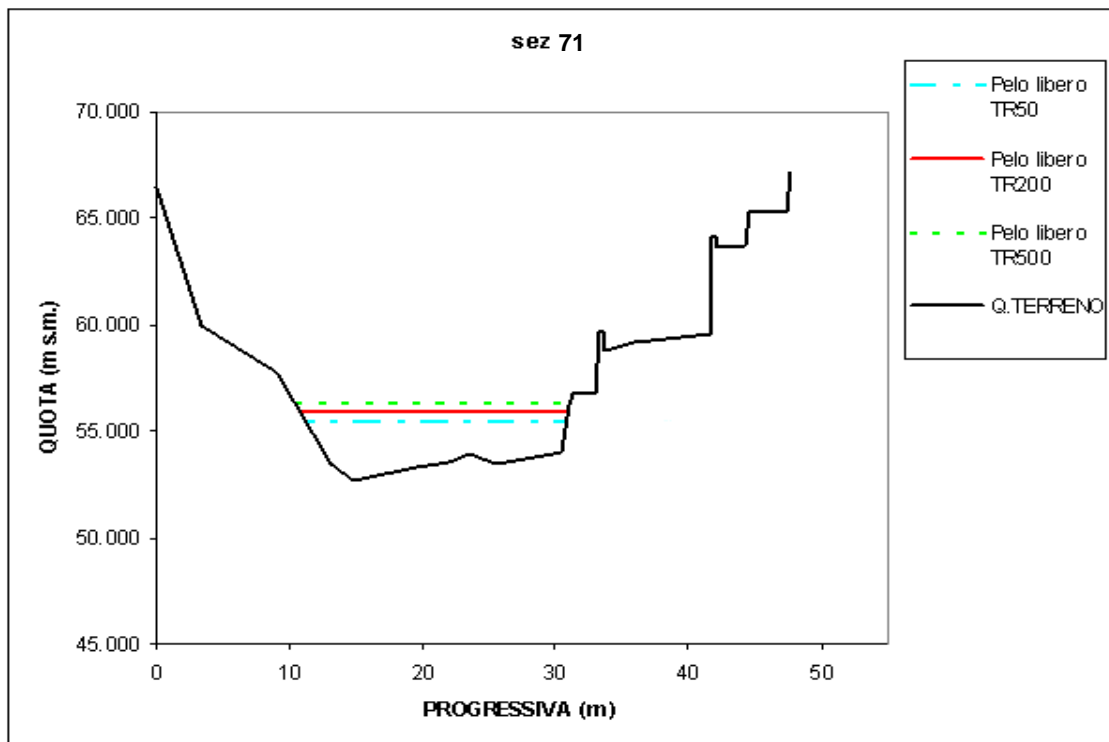

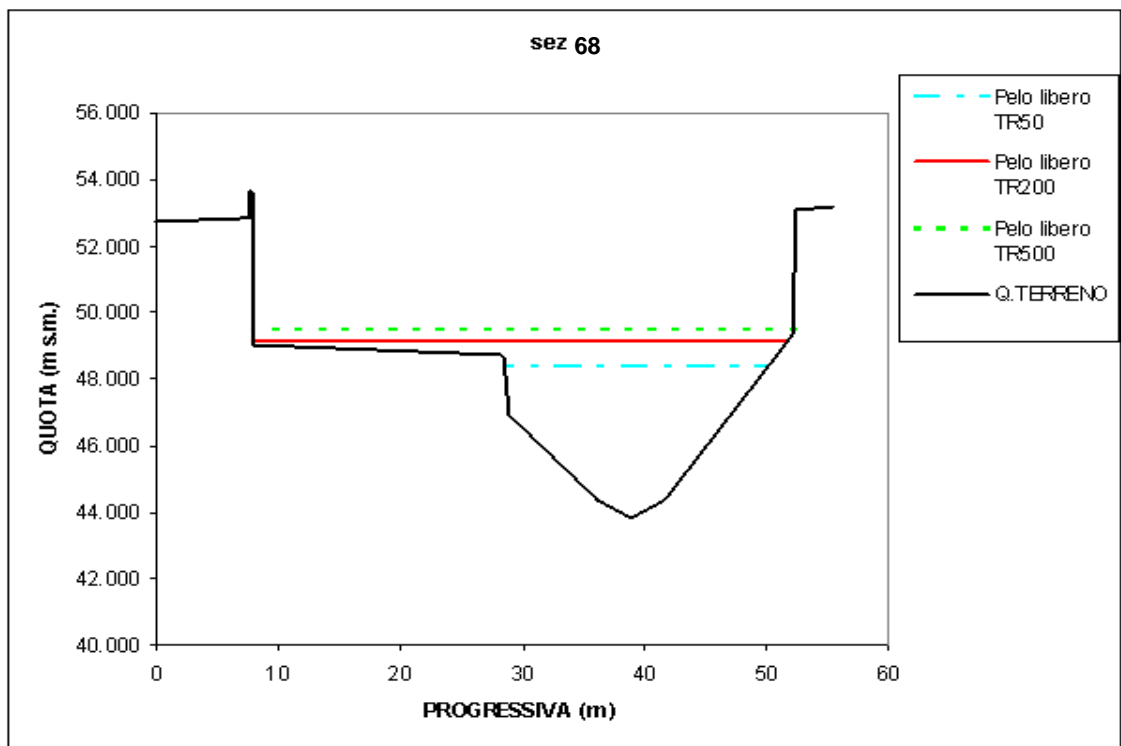
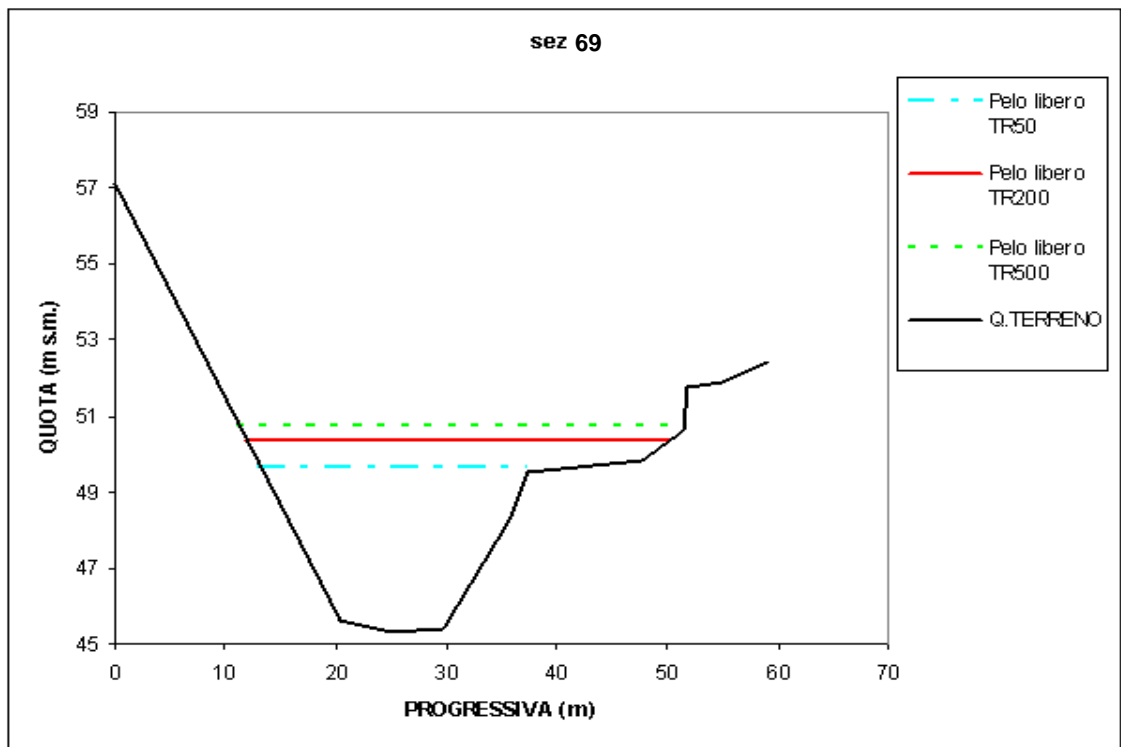

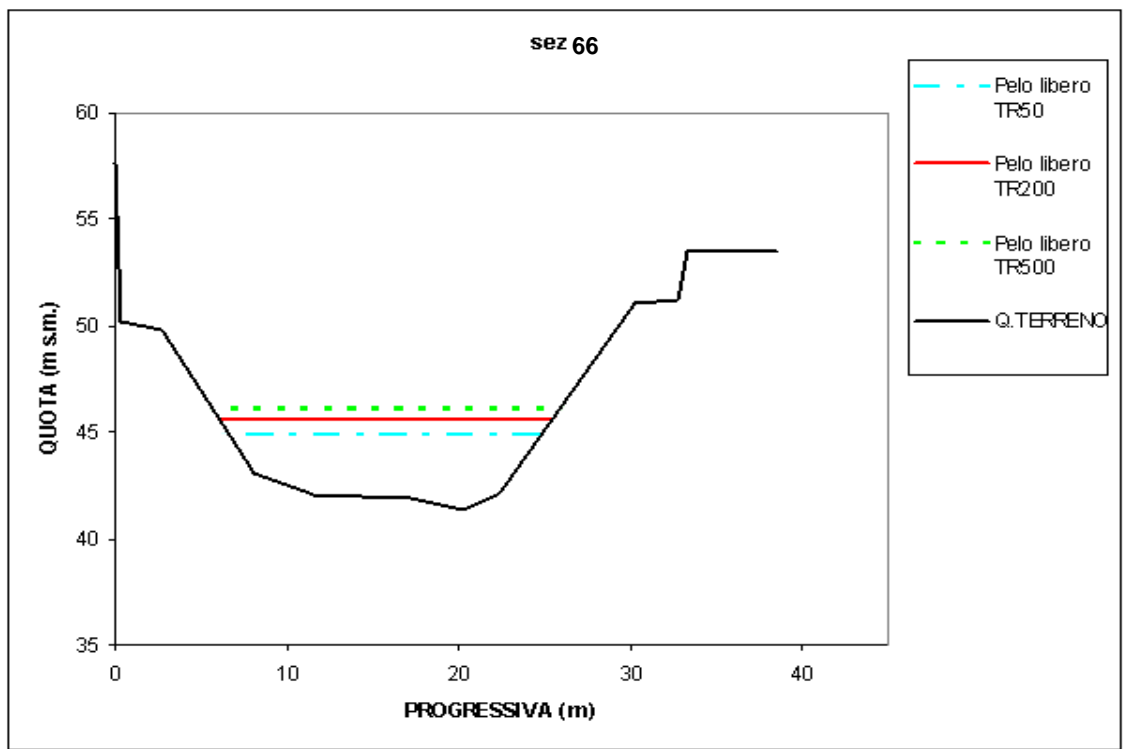
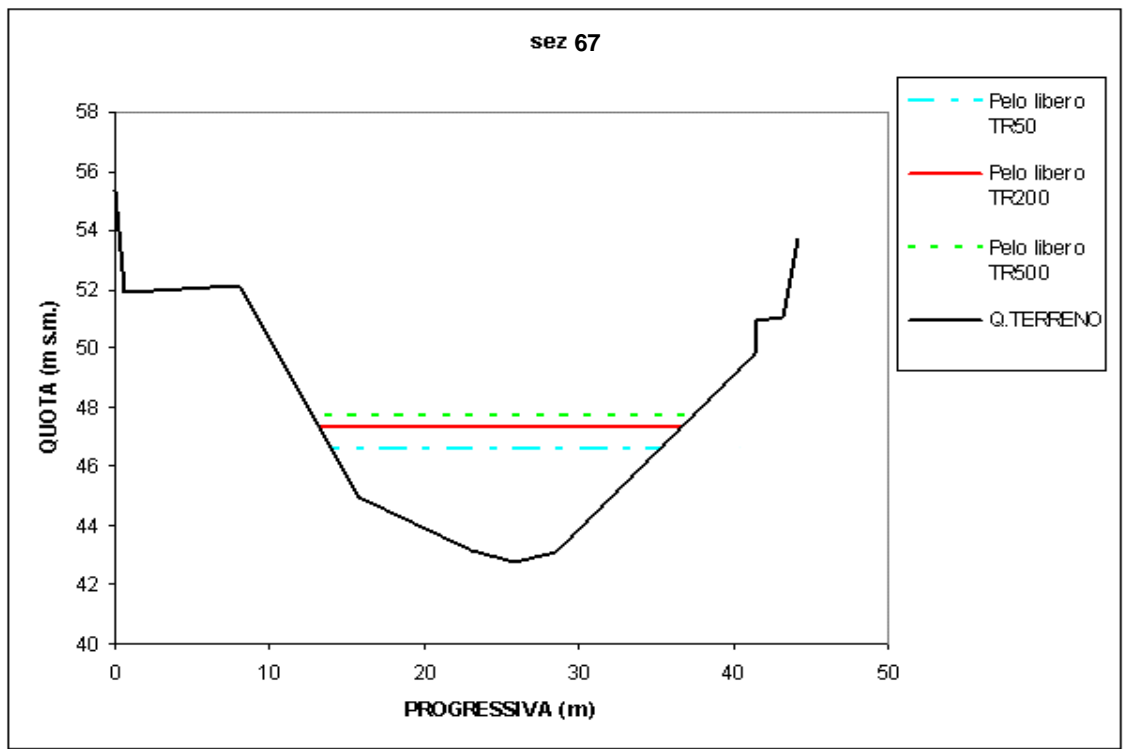

sez 65

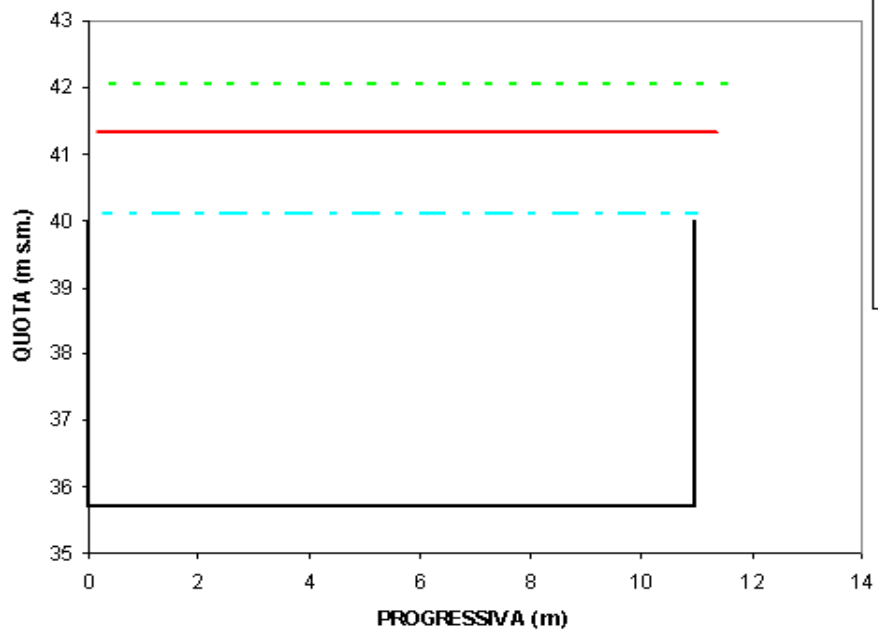

TORRENTE MAREMOLA – PROFILO DI CORRENTE PER T=50 ANNI							
ID Sez.	Progr. (m)	Quota fondo (m s.m.)	P.L. (m s.m.)	A (m ²)	b (m)	v (m/s)	Fr (-)
75	0.00	68.77	75.96	178.44	42.17	1.79	0.28
74	20.00	68.29	71.14	40.61	18.58	7.88	1.70
73	116.92	65.17	68.11	41.36	23.62	7.74	1.87
72	365.94	56.53	59.87	86.41	37.93	3.70	0.78
71	369.94	52.66	55.40	36.63	19.55	8.74	2.04
70	438.62	49.05	52.29	56.41	25.84	5.67	1.23
69	633.79	45.34	49.63	72.15	27.76	4.44	0.88
68	852.21	43.80	48.36	60.36	21.59	5.30	1.01
67	1044.33	42.78	46.60	51.80	21.28	6.18	1.26
66	1168.57	41.35	44.81	44.46	18.04	7.20	1.46
65	1399.09	35.70	40.10	48.40	11.00	6.61	1.01

Torrente Maremola - Risultati delle simulazioni idrauliche – T = 50 anni

TORRENTE MAREMOLA – PROFILO DI CORRENTE PER T=200 ANNI							
ID Sez.	Progr. (m)	Quota fondo (m s.m.)	P.L. (m s.m.)	A (m ²)	b (m)	v (m/s)	Fr (-)
75	0.00	68.77	77.38	238.55	42.17	1.93	0.26
74	20.00	68.29	71.74	52.45	20.90	8.77	1.77
73	116.92	65.17	68.61	53.62	25.52	8.58	1.89
72	365.94	56.53	60.61	114.71	38.61	4.01	0.74
71	369.94	52.66	55.93	47.10	20.15	9.77	2.04
70	438.62	49.05	52.94	73.79	28.42	6.23	1.24
69	633.79	45.34	50.36	97.86	38.55	4.70	0.94
68	852.21	43.80	49.11	81.32	43.74	5.66	1.32
67	1044.33	42.78	47.32	67.93	23.43	6.77	1.27
66	1168.57	41.35	45.59	59.07	19.36	7.79	1.42
65	1399.09	35.70	41.31	61.71	11.00	7.45	1.00

Torrente Maremola -Risultati delle simulazioni idrauliche – T = 200 anni

TORRENTE MAREMOLA – PROFILO DI CORRENTE PER T=500 ANNI							
ID Sez.	Progr. (m)	Quota fondo (m s.m.)	P.L. (m s.m.)	A (m ²)	b (m)	v (m/s)	Fr (-)
75	0.00	68.77	78.57	288.68	42.17	1.91	0.23
74	20.00	68.29	72.13	61.24	24.46	8.98	1.81
73	116.92	65.17	68.92	61.99	27.97	8.87	1.90
72	365.94	56.53	60.96	128.14	38.80	4.29	0.75
71	369.94	52.66	56.24	53.47	20.58	10.29	2.04
70	438.62	49.05	53.31	84.86	30.79	6.48	1.25
69	633.79	45.34	50.74	112.73	40.31	4.88	0.93
68	852.21	43.80	49.47	97.55	44.20	5.64	1.21
67	1044.33	42.78	47.74	78.11	24.69	7.04	1.26
66	1168.57	41.35	46.06	68.45	20.15	8.04	1.39
65	1399.09	35.70	42.04	69.74	11.00	7.89	1.00

Torrente Maremola -Risultati delle simulazioni idrauliche – T = 500 anni

T. MAREMOLA – località Ferriera

dalla SEZ. **1** (quota 310 m slm circa)

alla SEZ. **10** (quota 260 m slm circa)

- PROFILI DI RIGURGITO IN CONDIZIONI DI MOTO PERMANENTE PER LE PORTATE $T = 50, 200, 500$ ANNI

- GEOMETRIA DELLE SEZIONI ED ALTEZZA DEL PELO LIBERO IN CONDIZIONI DI MOTO PERMANENTE PER LE PORTATE $T = 50, 200, 500$ ANNI

- MODELLAZIONE IDRAULICA IN CONDIZIONI DI MOTO PERMANENTE:
TABELLE DELLE GRANDEZZE IDRAULICHE
SIGNIFICATIVE PER LE PORTATE $T = 50, 200, 500$ ANNI

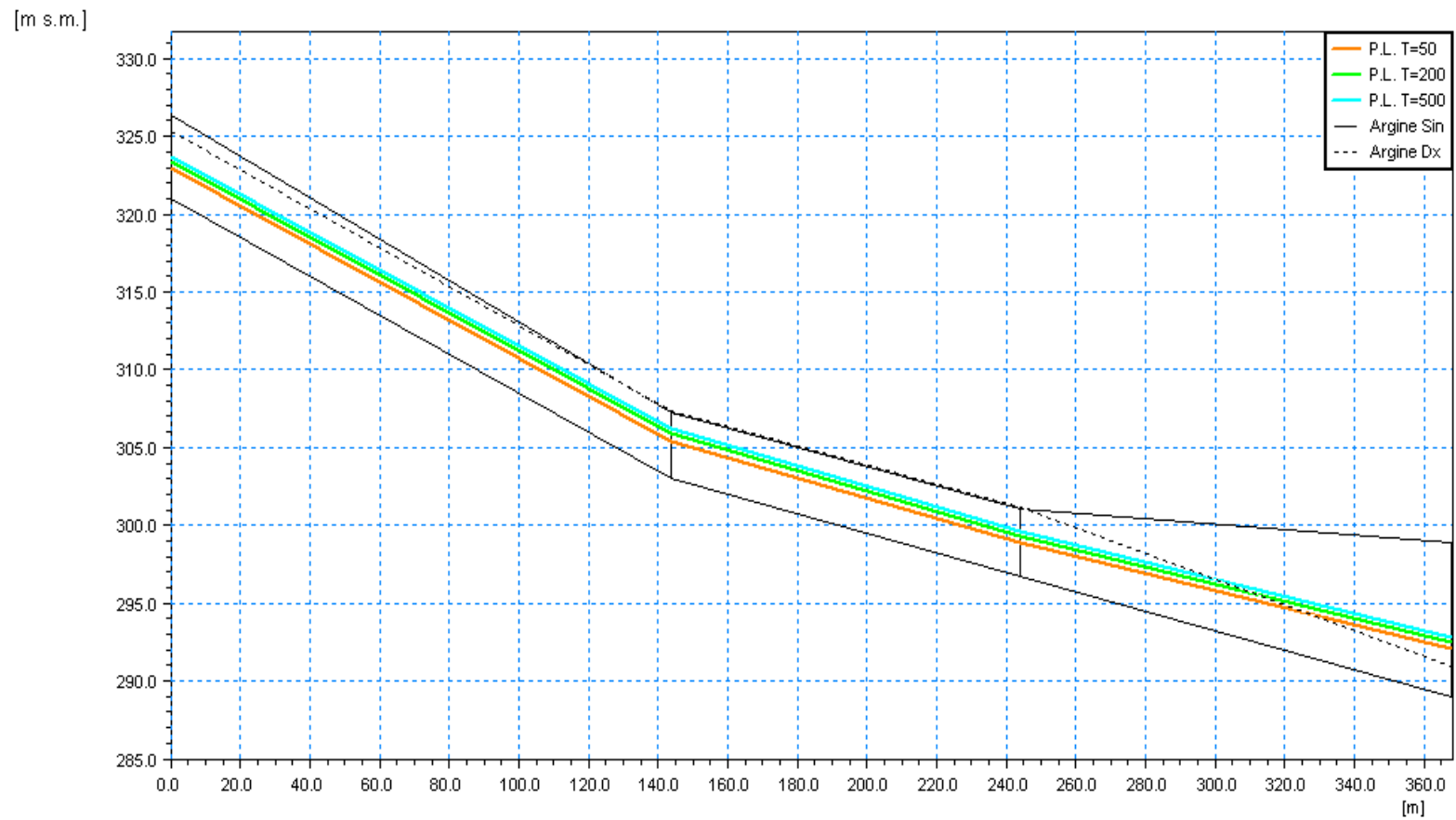

Progressiva	0.000	143.650	243.640	368.080
ID Sezione	1	2	3	4

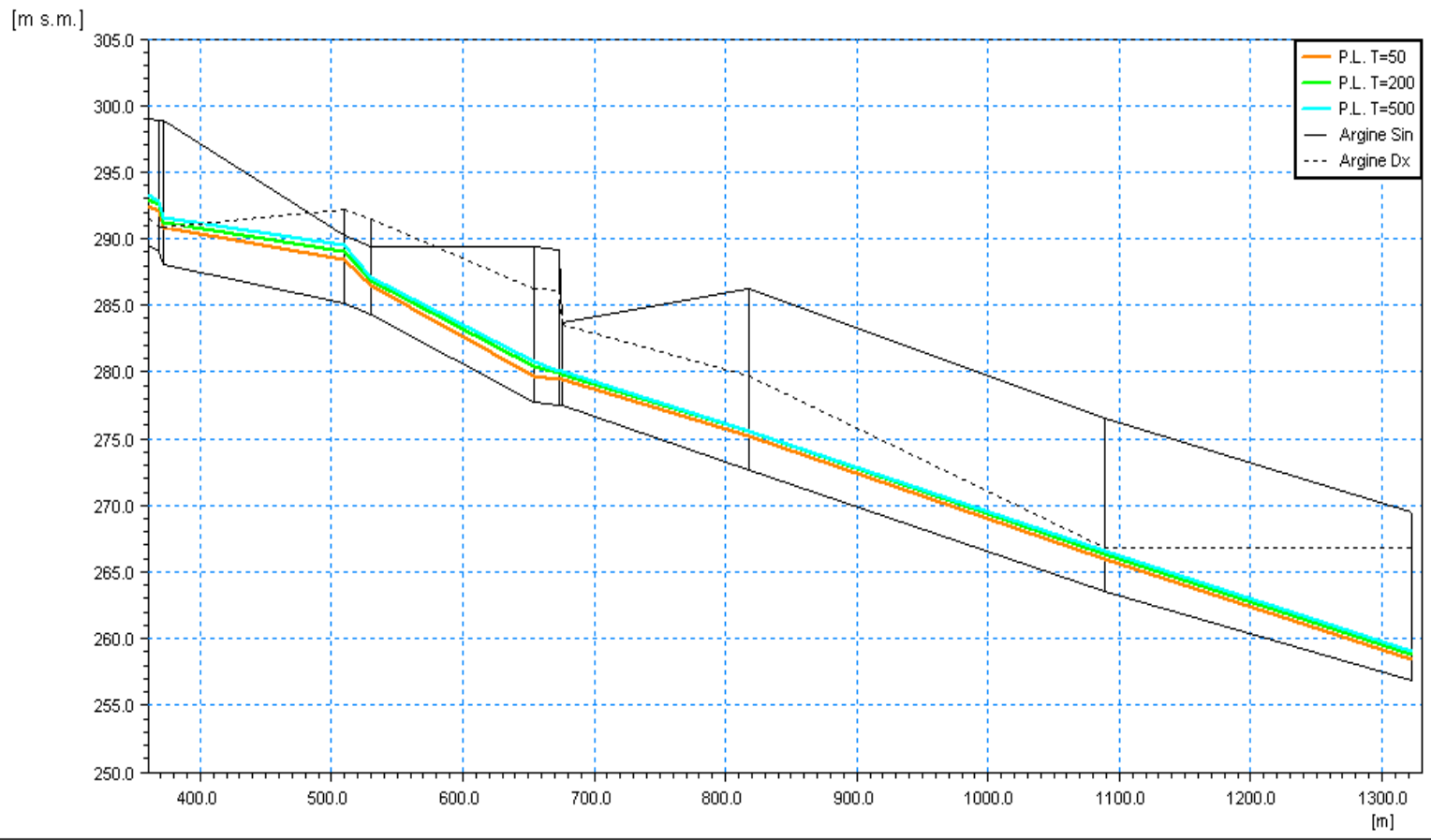

Progressiva	368.080	509.910	529.910	653.850	673.850	817.910	1068.670	1322.350
ID Sezione	4	5m	5v	6m	6v	8	9	10

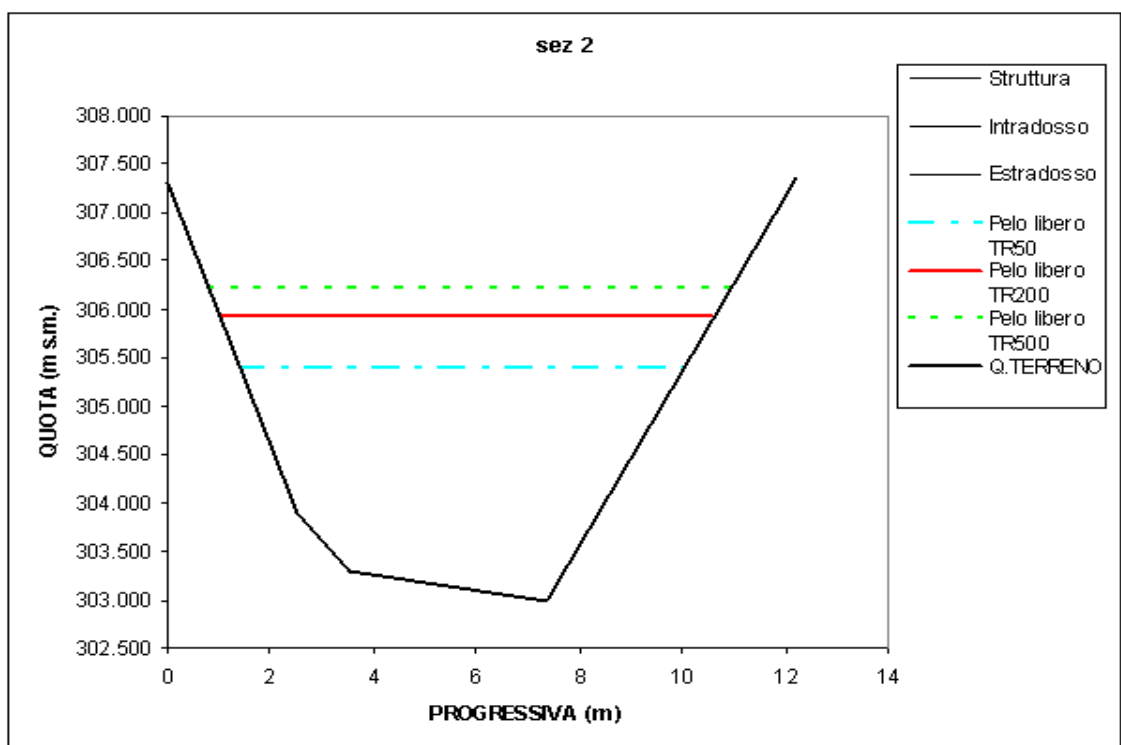
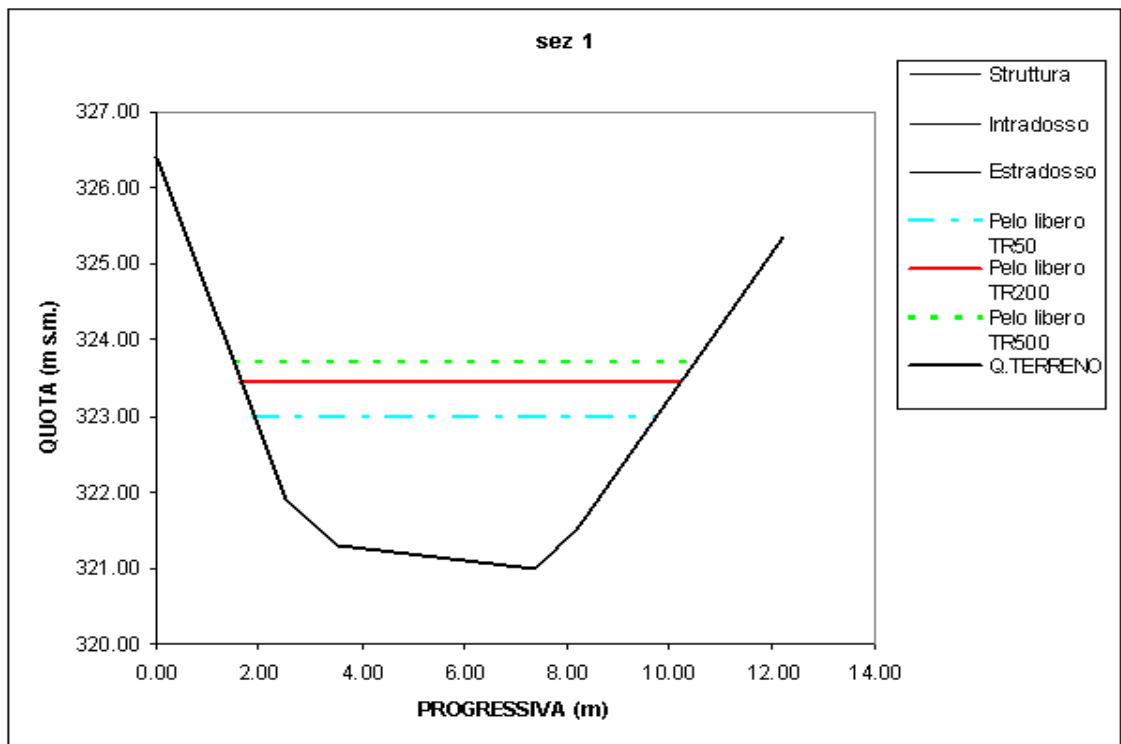

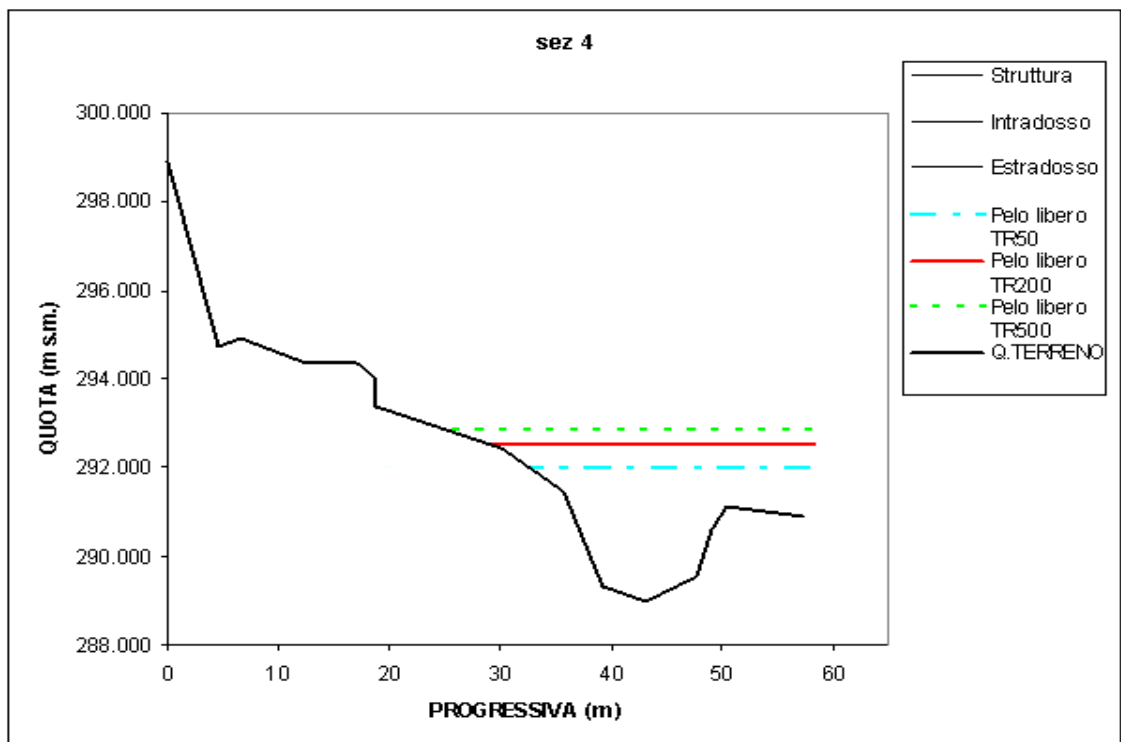
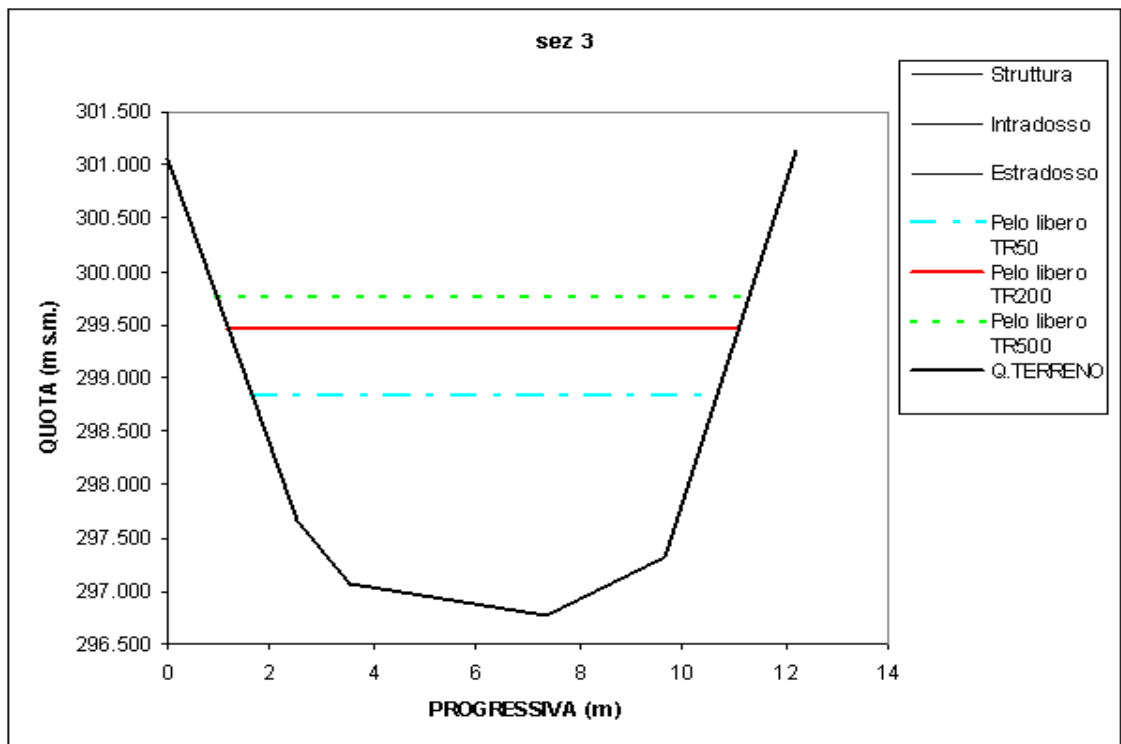

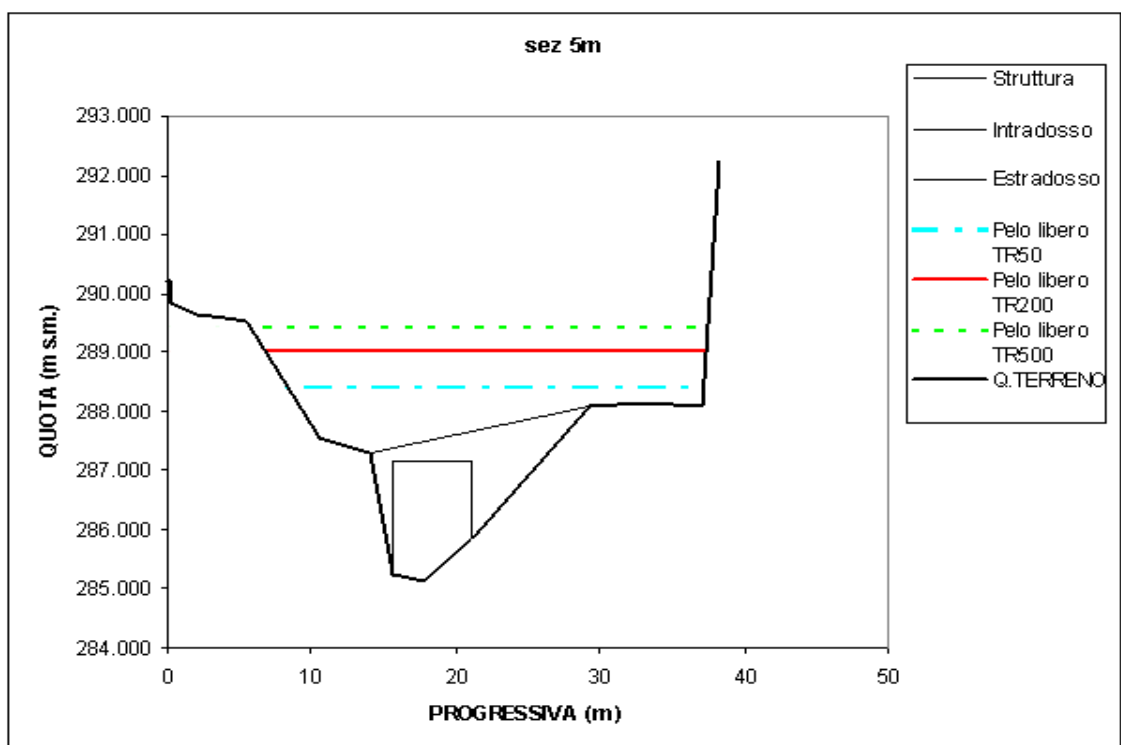
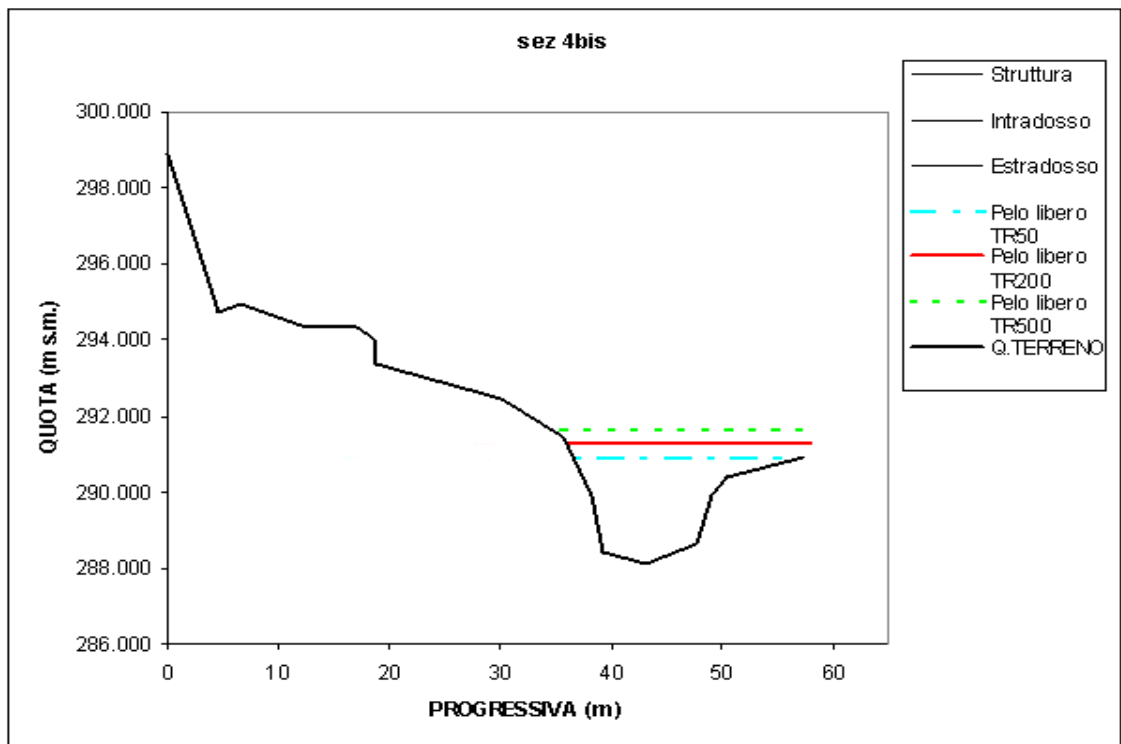

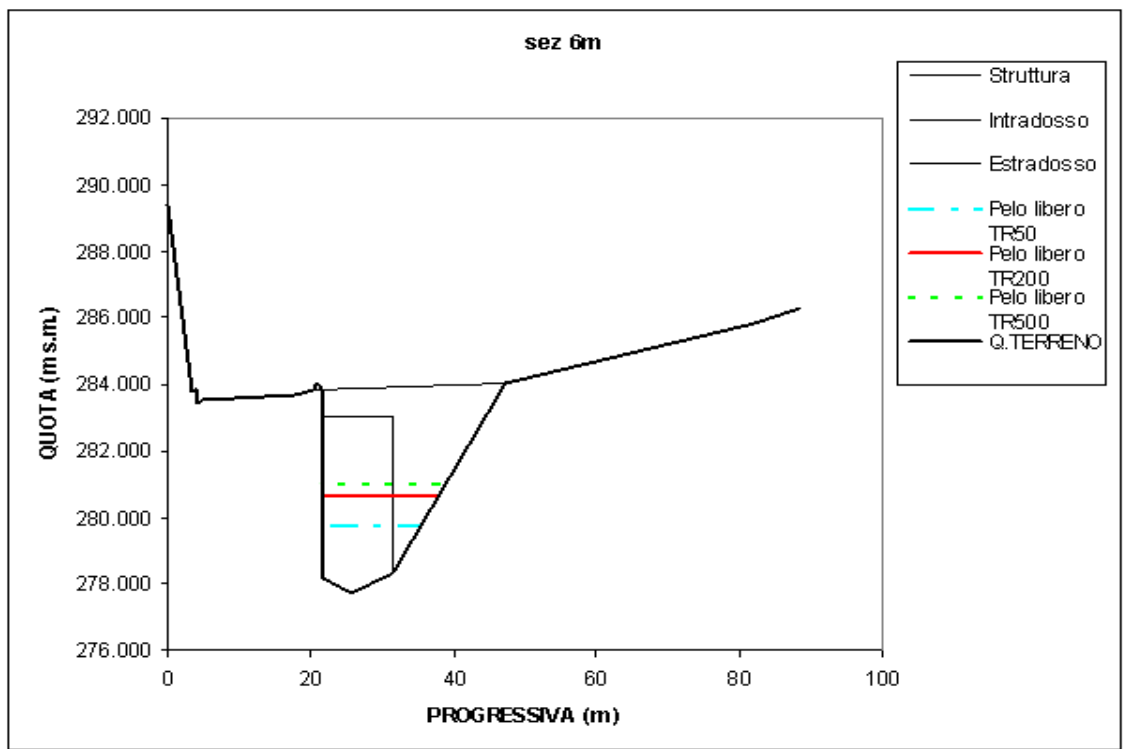
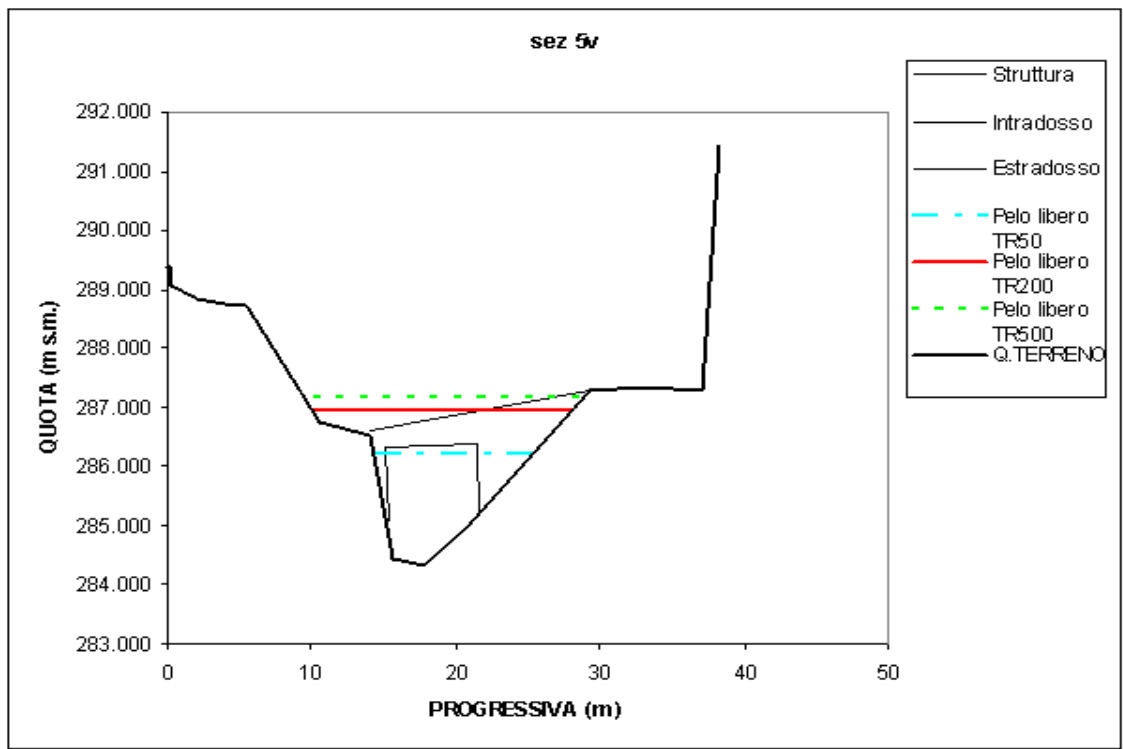

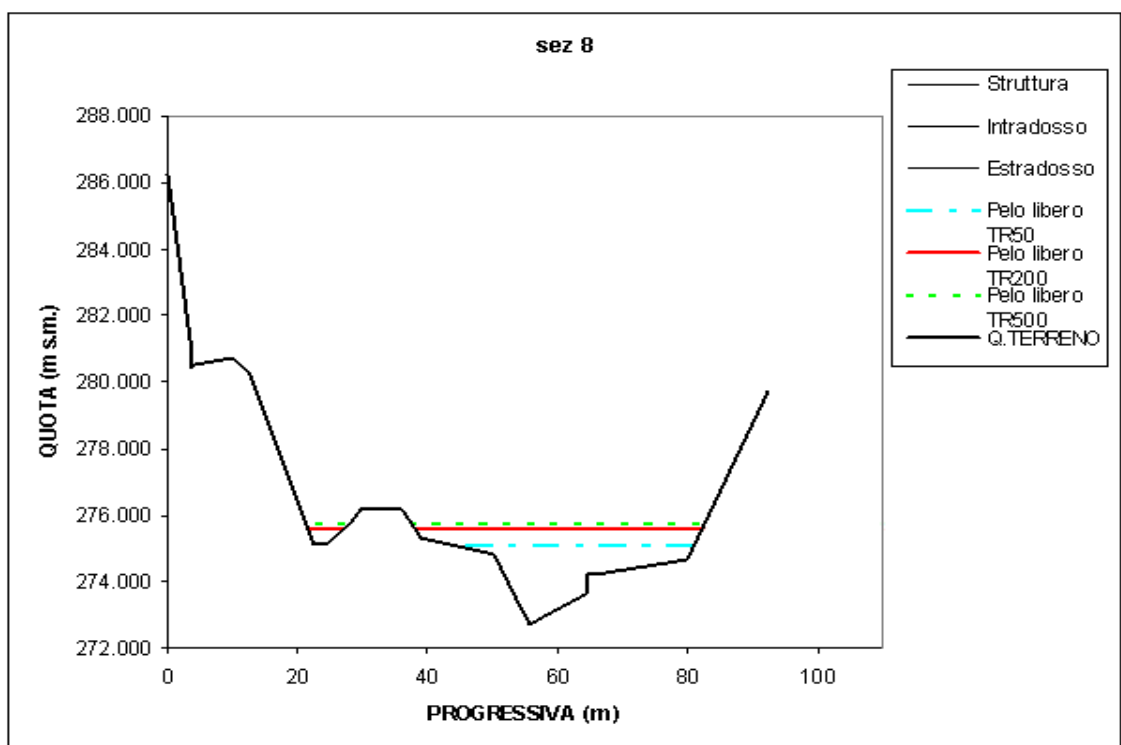
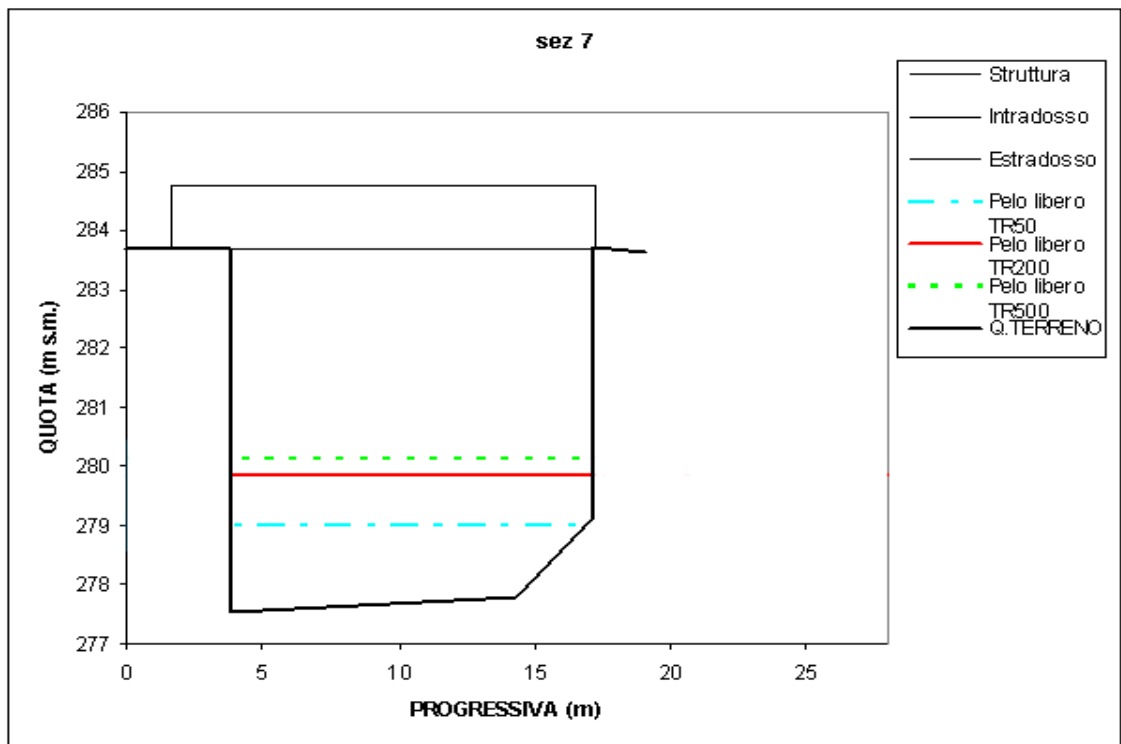

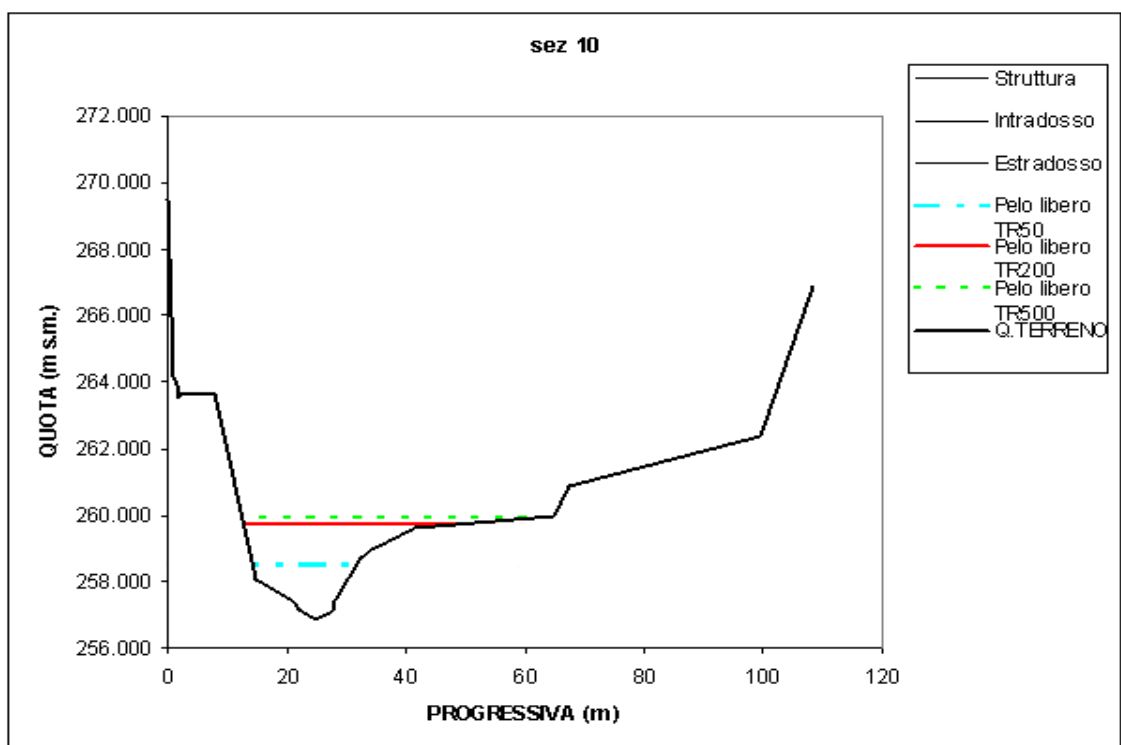
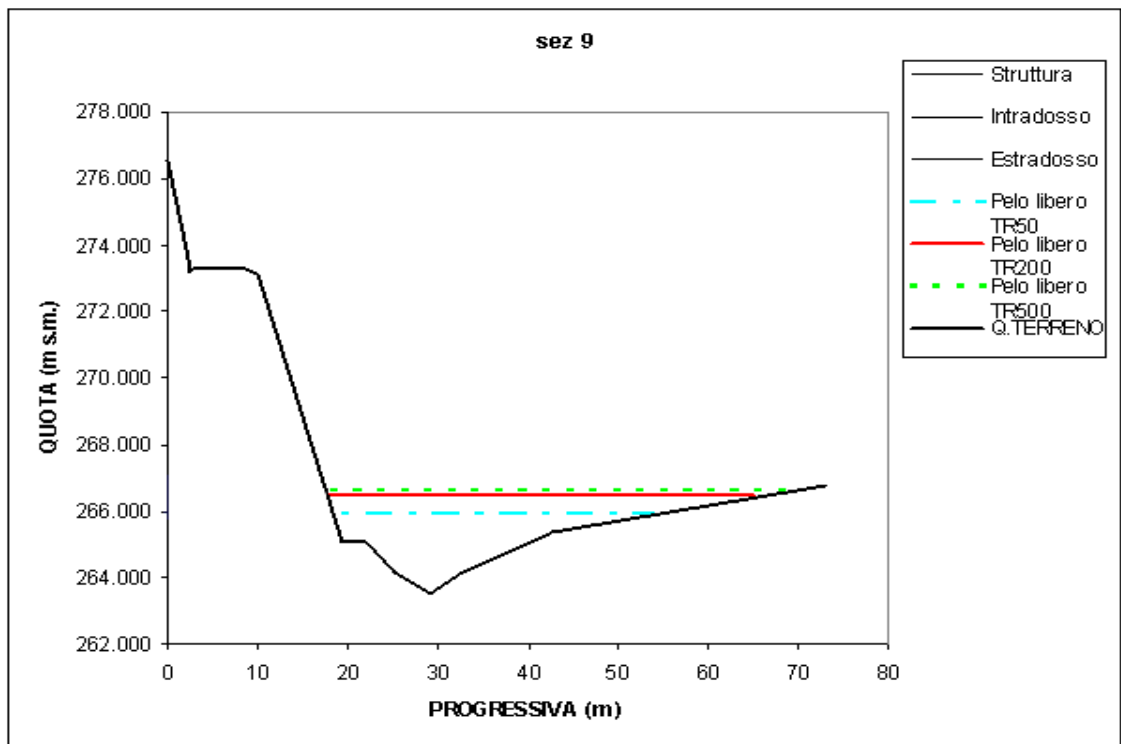

TORRENTE MAREMOLA – PROFILO DI CORRENTE PER T=50 ANNI							
ID Sez.	Progr. (m)	Quota fondo (m s.m.)	P.L. (m s.m.)	A (m ²)	b (m)	v (m/s)	Fr (-)
1	0.00	320.99	322.98	11.60	7.87	10.02	2.64
2	143.65	303.00	305.39	14.68	8.67	7.91	1.94
3	243.84	296.76	298.84	15.57	9.23	7.45	1.83
4	368.08	288.99	291.97	41.66	24.87	2.79	0.69
4bis	372.08	288.11	290.87	31.89	20.75	3.64	0.94
5m	509.91	285.14	288.40	63.15	31.18	1.84	0.41
5v	529.91	284.34	286.22	18.42	15.18	6.30	1.82
6m	653.85	277.76	279.73	45.84	18.31	3.53	0.51
6v	673.85	277.55	279.06	20.11	13.92	4.77	1.53
7	675.55	277.53	279.01	21.64	13.34	4.36	1.34
8	817.91	272.70	275.08	42.16	41.58	3.37	1.07
9	1088.67	263.51	265.91	42.78	39.16	4.49	1.37
10	1322.35	256.86	258.47	30.09	23.17	6.38	1.79

Torrente Maremola - Risultati delle simulazioni idrauliche – T = 50 anni

TORRENTE MAREMOLA – PROFILO DI CORRENTE PER T=200 ANNI							
ID Sez.	Progr. (m)	Quota fondo (m s.m.)	P.L. (m s.m.)	A (m ²)	b (m)	v (m/s)	Fr (-)
1	0.00	320.99	323.45	15.15	8.56	11.09	2.66
2	143.65	303.00	305.93	19.23	9.59	8.74	1.97
3	243.84	296.76	299.47	20.28	9.92	8.28	1.85
4	368.08	288.99	292.52	54.82	28.23	3.06	0.70
4bis	372.08	288.11	291.30	37.40	21.39	4.49	1.08
5m	509.91	285.14	289.00	54.51	30.38	3.08	0.73
5v	529.91	284.34	286.96	23.21	18.06	6.24	2.04
6m	653.85	277.76	280.61	33.26	16.31	5.05	1.13
6v	673.85	277.55	279.94	26.03	15.05	5.45	1.57
7	675.55	277.53	279.87	27.11	13.35	5.30	1.39
8	817.91	272.70	275.56	56.65	49.92	3.63	1.09
9	1088.67	263.51	266.43	58.08	47.29	4.79	1.38
10	1322.35	256.86	259.72	45.67	38.42	6.09	1.78

Torrente Maremola -Risultati delle simulazioni idrauliche – T = 200 anni

TORRENTE MAREMOLA – PROFILO DI CORRENTE PER T=500 ANNI							
ID	Progr.	Quota	P.L.	A	b	v	Fr

Sez.	(m)	fondo (m s.m.)	(m s.m.)	(m ²)	(m)	(m/s)	(-)
1	0.00	320.99	323.70	17.40	8.97	11.67	2.68
2	143.65	303.00	306.22	22.11	10.13	9.18	1.98
3	243.84	296.76	299.76	23.26	10.34	8.73	1.86
4	368.08	288.99	292.83	63.99	31.88	3.17	0.71
4bis	372.08	288.11	291.59	43.74	22.46	4.64	1.06
5m	509.91	285.14	289.41	69.07	31.71	2.94	0.64
5v	529.91	284.34	287.16	27.29	19.41	6.44	2.00
6m	653.85	277.76	280.98	39.52	17.33	5.14	1.09
6v	673.85	277.55	280.18	29.79	15.72	5.81	1.58
7	675.55	277.53	280.12	30.36	13.35	5.69	1.42
8	817.91	272.70	275.71	64.41	51.78	3.86	1.10
9	1088.67	263.51	266.61	67.13	51.15	4.99	1.39
10	1322.35	256.86	259.94	55.32	46.81	6.06	1.78

Torrente Maremola -Risultati delle simulazioni idrauliche – T = 500 anni

T. GIUSTENICE o SCARINCIO – tratto di valle

dalla SEZ. **14** (loc. Fornace, quota 20 m slm circa)
alla SEZ. **1** (confluenza con T. Maremola)

- PROFILI DI RIGURGITO IN CONDIZIONI DI MOTO PERMANENTE PER LE PORTATE $T = 50, 200, 500$ ANNI

- GEOMETRIA DELLE SEZIONI ED ALTEZZA DEL PELO LIBERO IN CONDIZIONI DI MOTO PERMANENTE PER LE PORTATE $T = 50, 200, 500$ ANNI

- MODELLAZIONE IDRAULICA IN CONDIZIONI DI MOTO PERMANENTE:
TABELLE DELLE GRANDEZZE IDRAULICHE
SIGNIFICATIVE PER LE PORTATE $T = 50, 200, 500$ ANNI

Torrente Maremola e Rio Giustenice Plan: _settembre_2017_portate

Giustenice confluenza

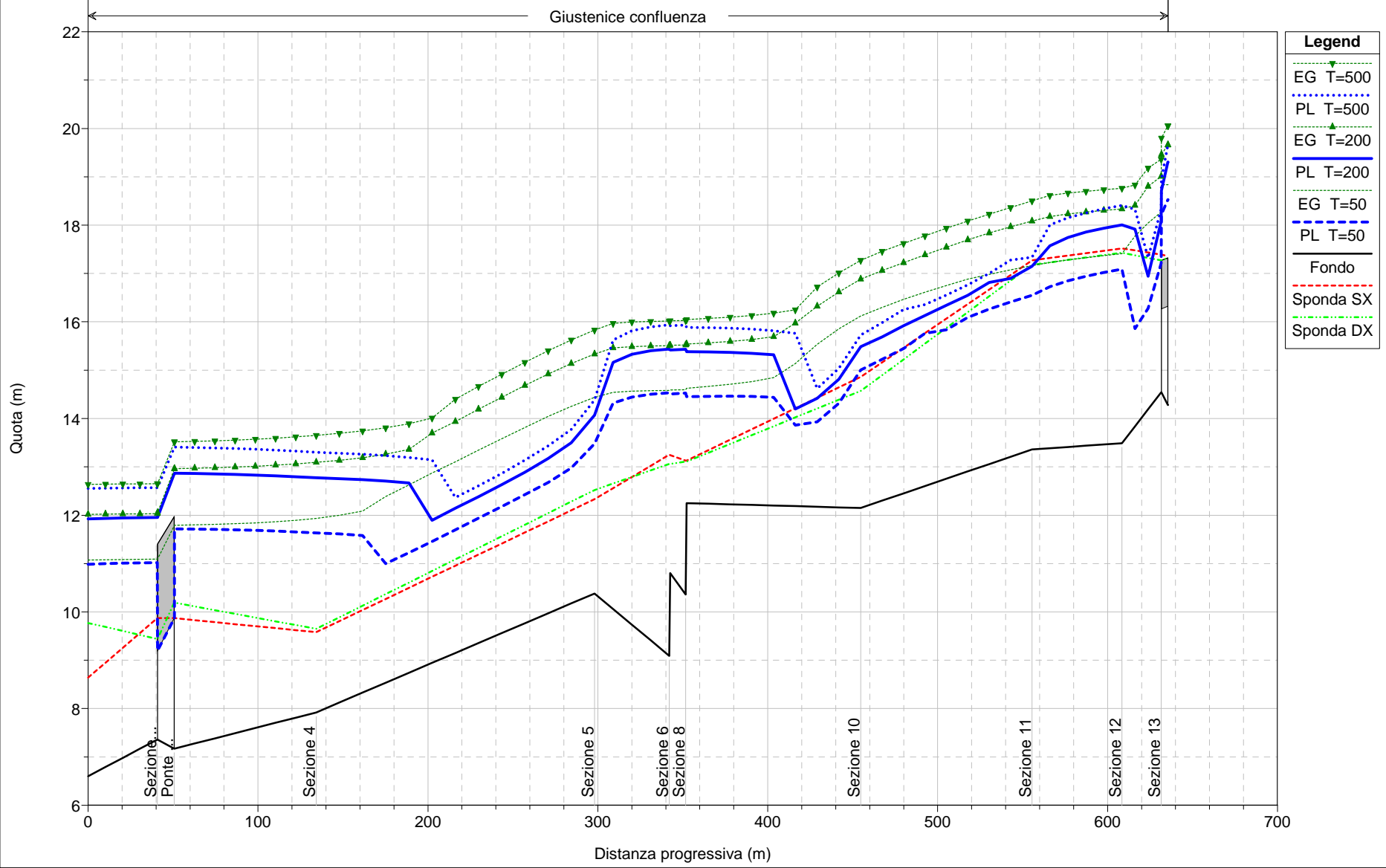

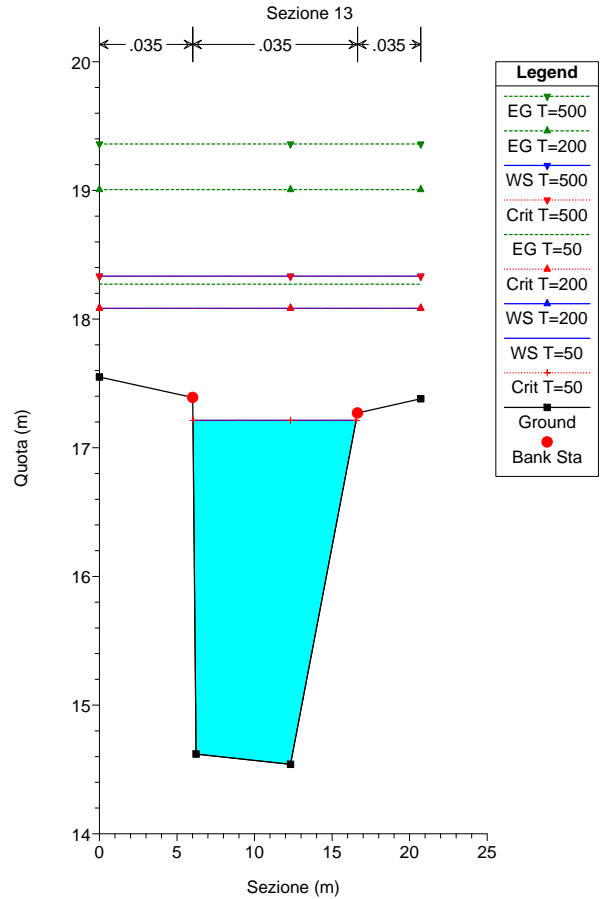
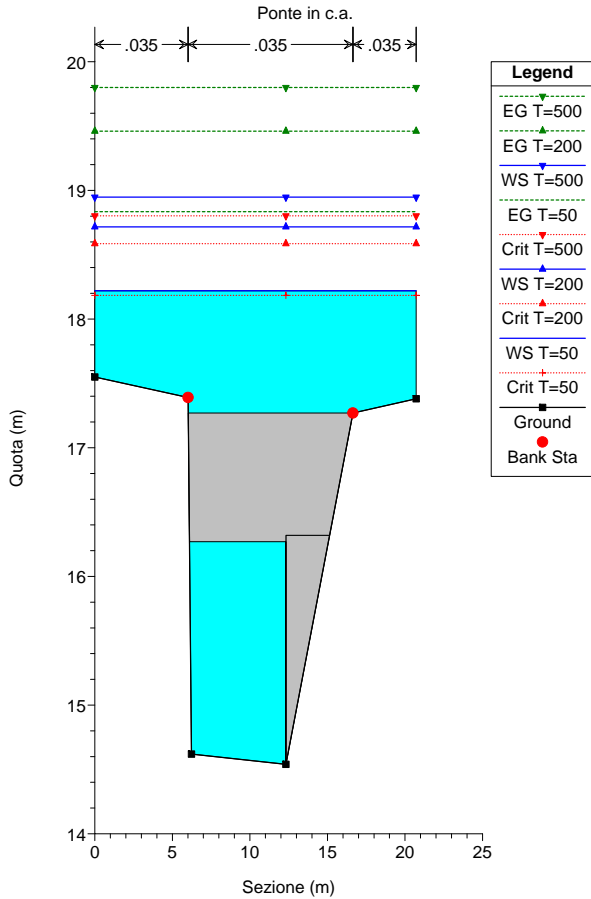
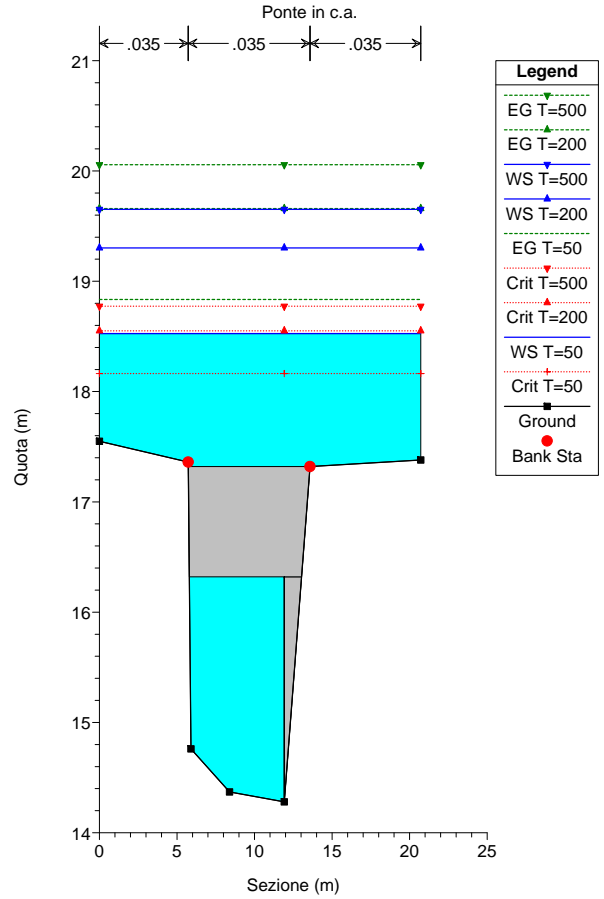
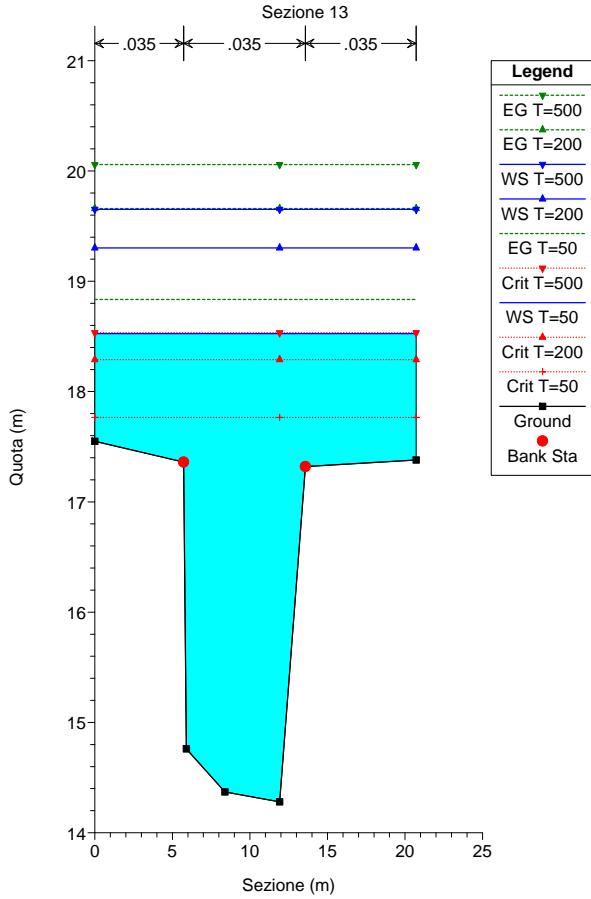

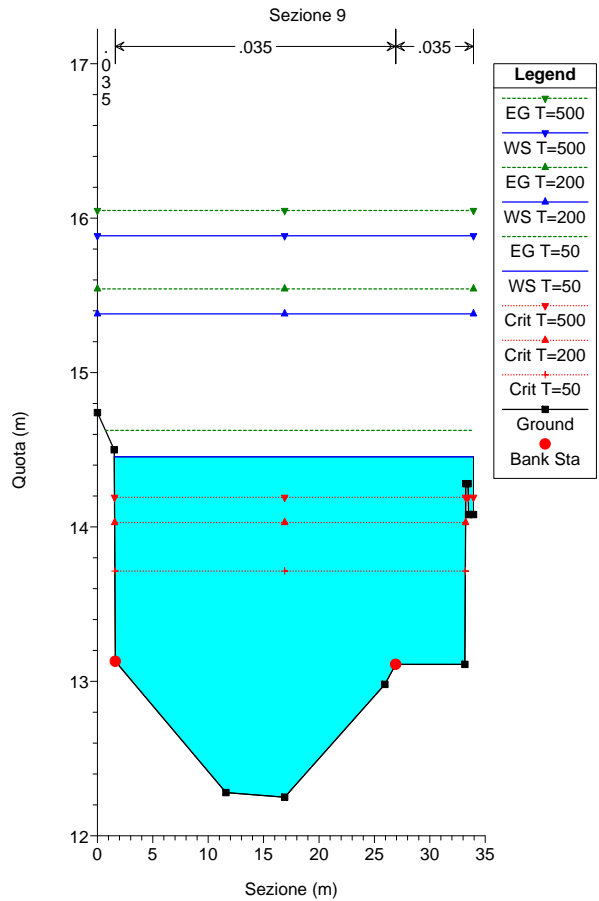
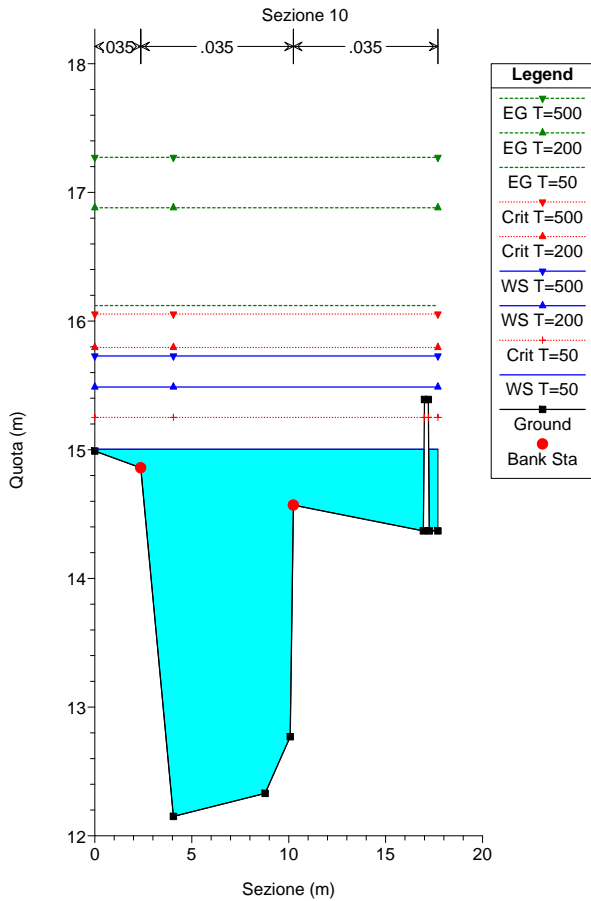
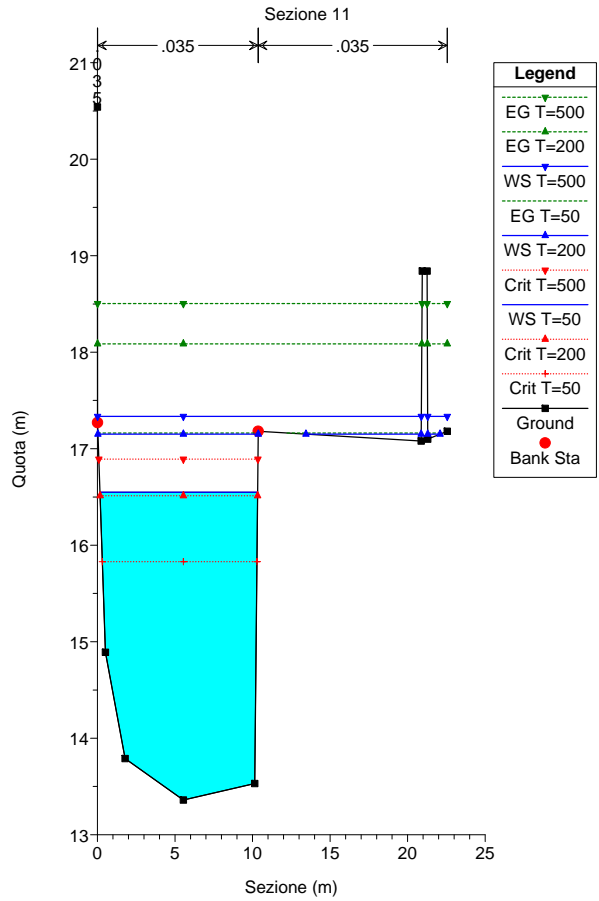
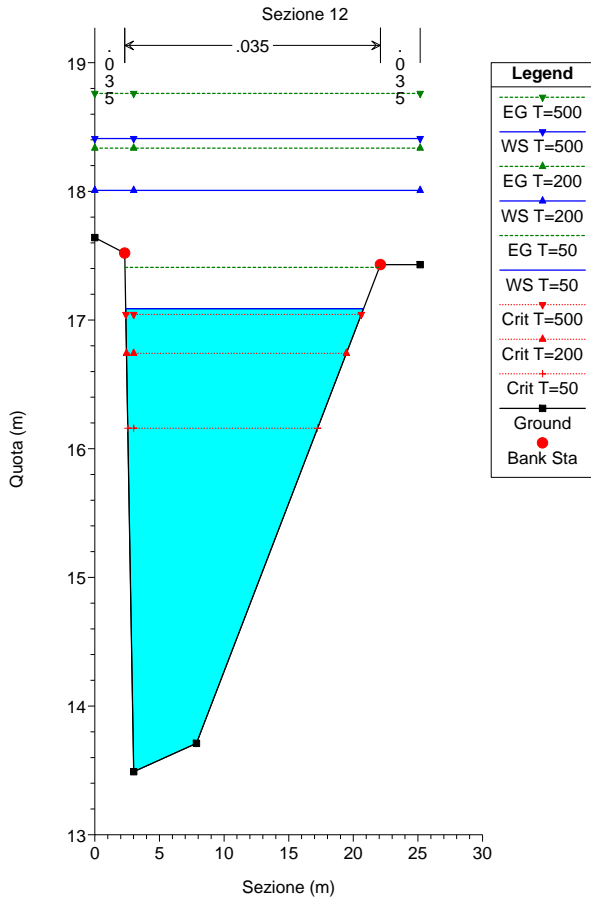

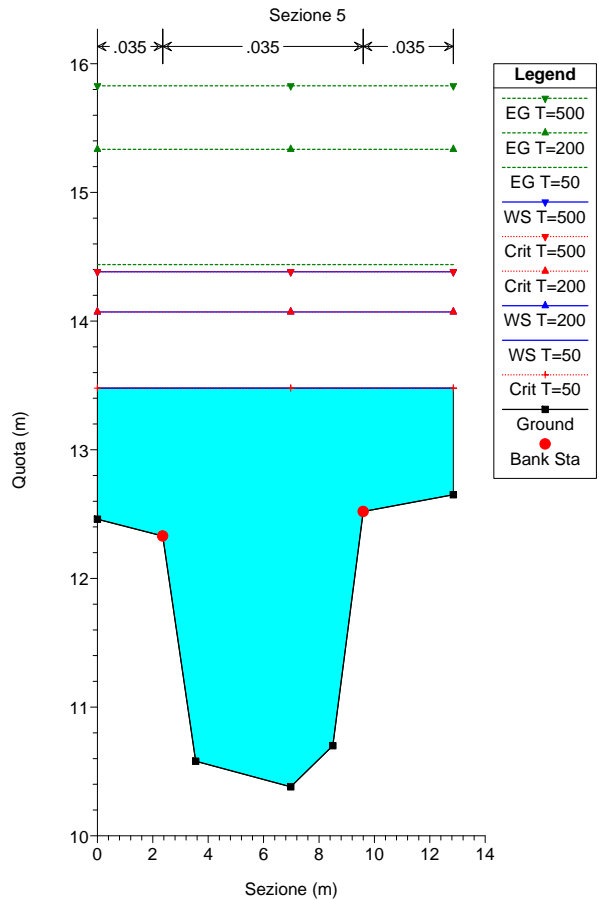
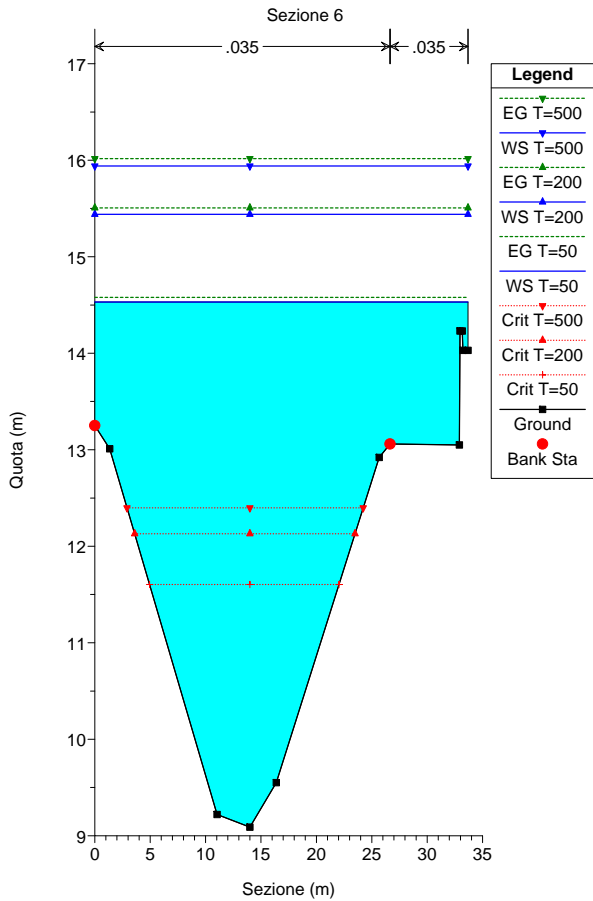
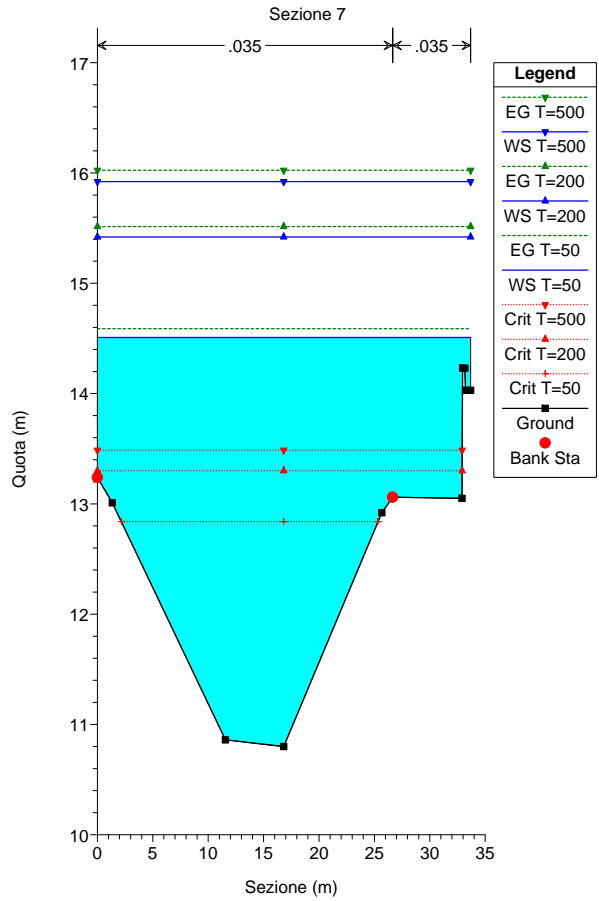
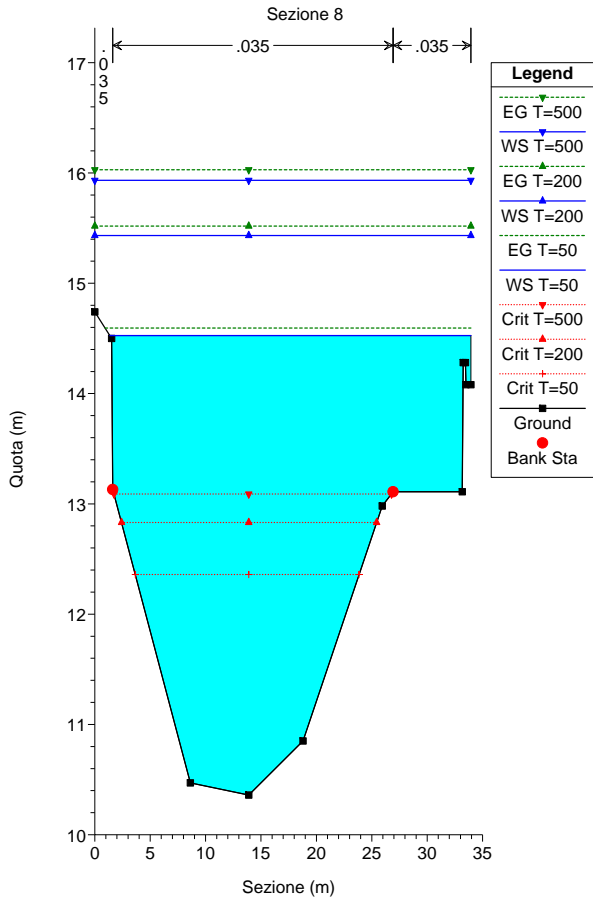

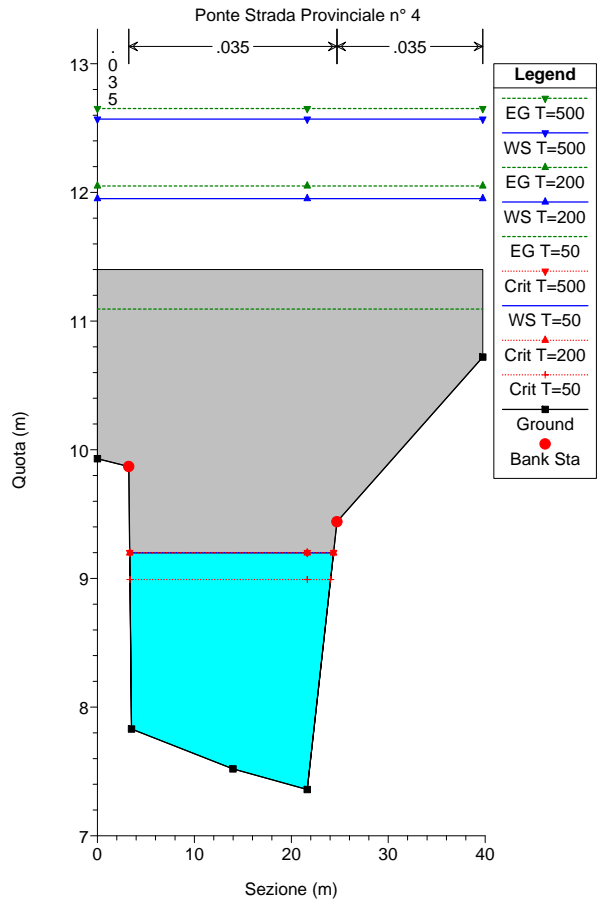
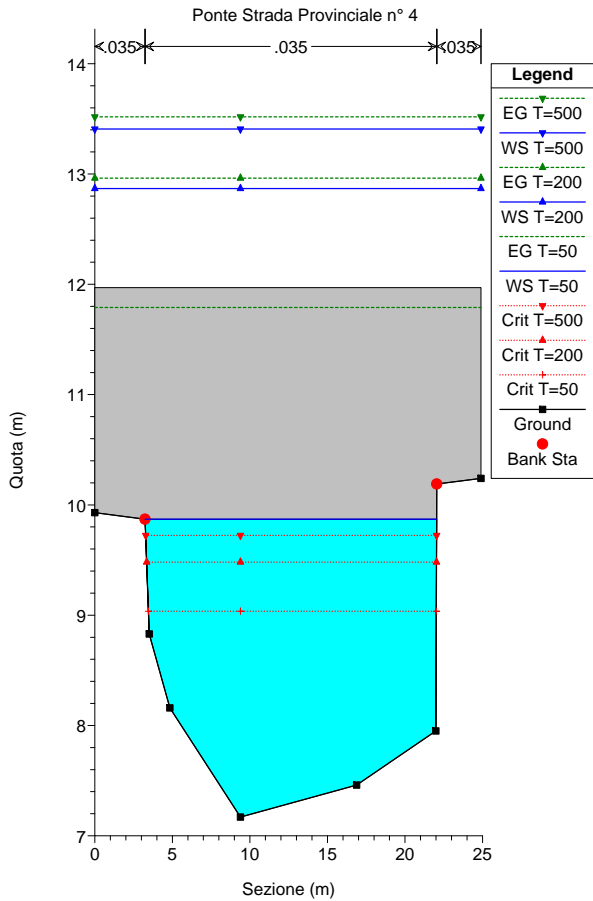
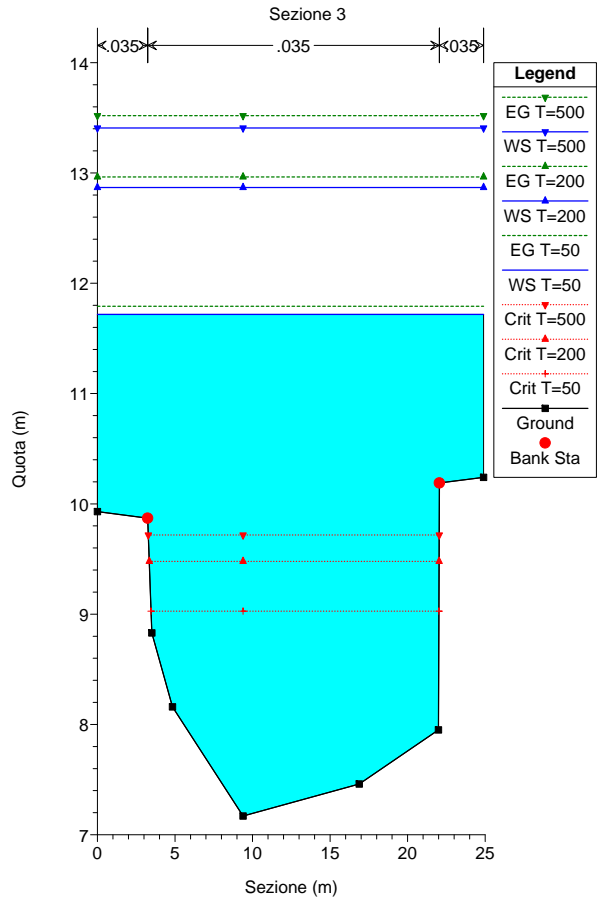
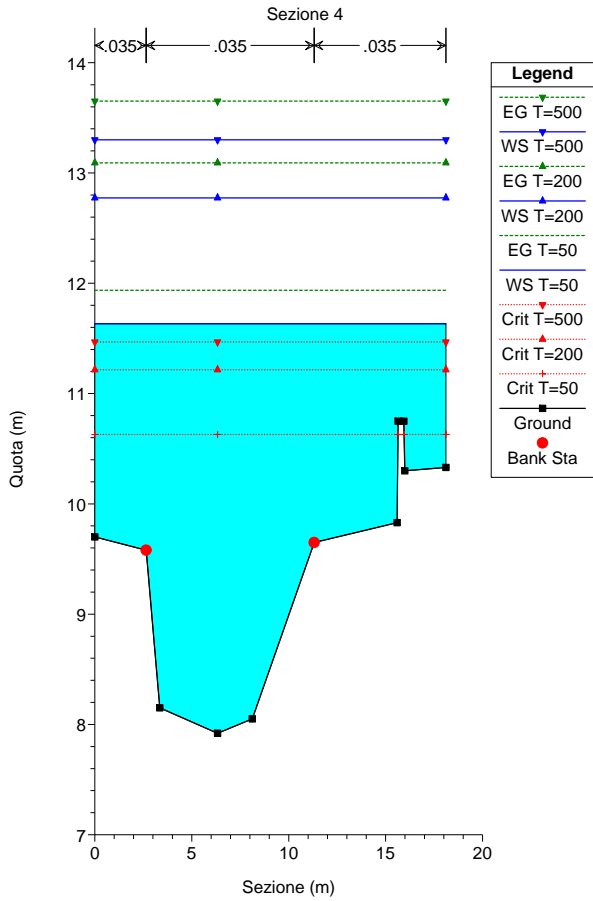

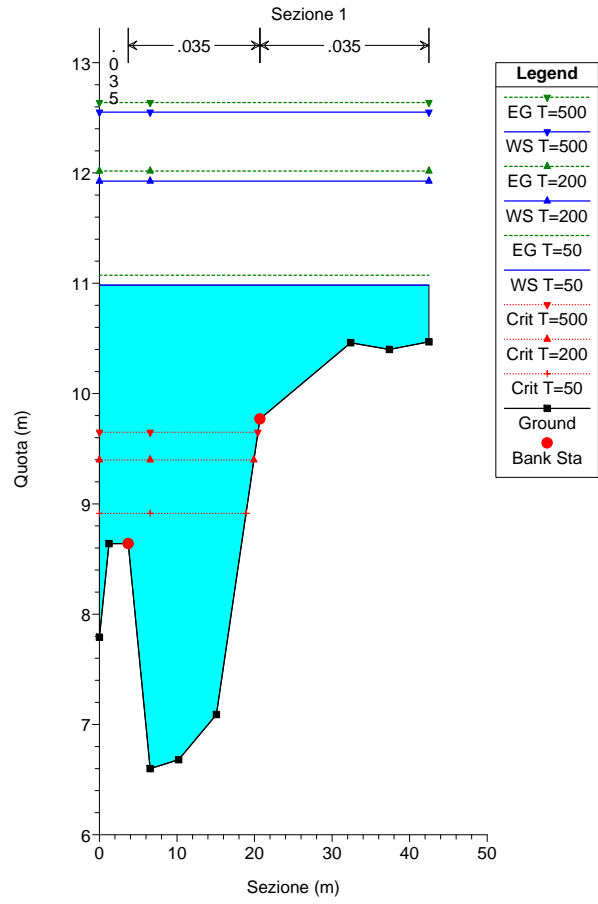
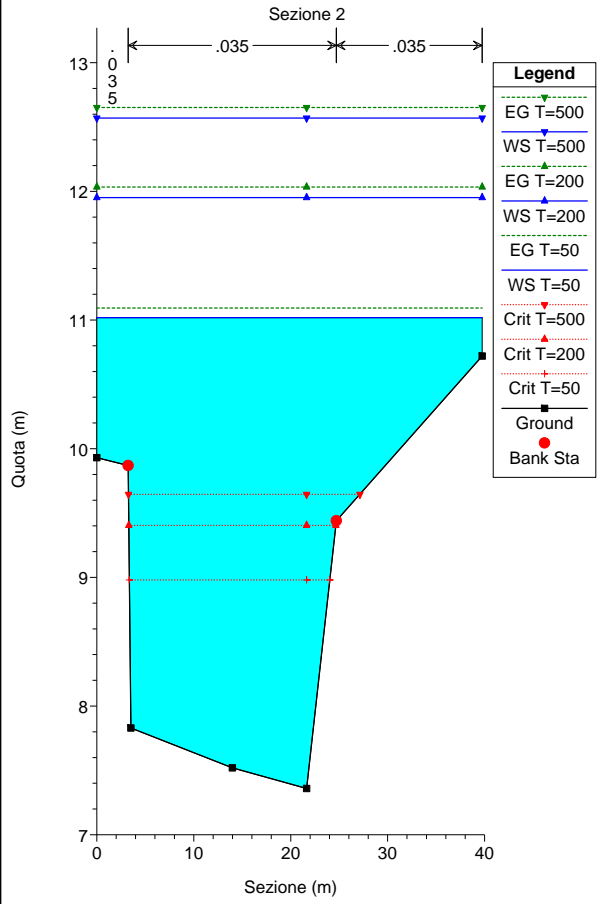

HEC-RAS Plan: attuale_sett_17 River: Giustenice Reach: confluenza

Reach	River Sta	Profile	Q Total (m3/s)	Min Ch El (m)	W.S. Elev (m)	LOB Elev (m)	L. Freeboard (m)	ROB Elev (m)	R. Freeboard (m)	Crit W.S. (m)	E.G. Elev (m)	E.G. Slope (m/m)	Vel Chnl (m/s)	Flow Area (m2)	Top Width (m)	Froude # Chl
confluenza	14	T=50	100.00	14.28	18.53	17.36	-1.17	17.32	-1.21	17.77	18.84	0.002647	2.67	44.16	20.72	0.44
confluenza	14	T=200	150.00	14.28	19.30	17.36	-1.94	17.32	-1.98	18.29	19.66	0.002483	2.93	60.25	20.72	0.44
confluenza	14	T=500	180.00	14.28	19.65	17.36	-2.29	17.32	-2.33	18.53	20.06	0.002572	3.13	67.51	20.72	0.45
confluenza	13.5		Bridge													
confluenza	13	T=50	100.00	14.54	17.21	17.39	0.18	17.27	0.06	17.21	18.27	0.013570	4.56	21.94	10.52	1.01
confluenza	13	T=200	150.00	14.54	18.08	17.39	-0.69	17.27	-0.81	18.08	19.01	0.008174	4.41	37.97	20.72	0.82
confluenza	13	T=500	180.00	14.54	18.33	17.39	-0.94	17.27	-1.06	18.33	19.36	0.008355	4.71	43.14	20.72	0.84
confluenza	12	T=50	100.00	13.49	17.09	17.52	0.43	17.43	0.34	16.16	17.41	0.003461	2.51	39.87	18.40	0.54
confluenza	12	T=200	150.00	13.49	18.01	17.52	-0.49	17.43	-0.58	16.74	18.34	0.002431	2.56	60.57	25.17	0.48
confluenza	12	T=500	180.00	13.49	18.41	17.52	-0.89	17.43	-0.98	17.04	18.76	0.002213	2.66	70.71	25.17	0.47
confluenza	11	T=50	100.00	13.36	16.55	17.27	0.72	17.18	0.63	15.83	17.16	0.006056	3.47	28.82	10.17	0.66
confluenza	11	T=200	150.00	13.36	17.15	17.27	0.12	17.18	0.03	16.51	18.09	0.007925	4.29	35.27	18.55	0.74
confluenza	11	T=500	180.00	13.36	17.33	17.27	-0.06	17.18	-0.15	16.89	18.50	0.009458	4.82	39.28	22.13	0.82
confluenza	10	T=50	100.00	12.15	15.00	14.86	-0.14	14.57	-0.43	15.25	16.12	0.014069	4.85	23.06	17.46	1.00
confluenza	10	T=200	150.00	12.15	15.49	14.86	-0.63	14.57	-0.92	15.79	16.88	0.014547	5.57	31.56	17.70	1.04
confluenza	10	T=500	180.00	12.15	15.73	14.86	-0.87	14.57	-1.16	16.05	17.27	0.014820	5.93	35.81	17.70	1.07
confluenza	9	T=50	100.00	12.25	14.45	13.13	-1.32	13.11	-1.34	13.71	14.63	0.001925	1.89	55.81	32.43	0.44
confluenza	9	T=200	150.00	12.25	15.38	13.13	-2.25	13.11	-2.27	14.03	15.54	0.001068	1.85	87.01	33.95	0.35
confluenza	9	T=500	180.00	12.25	15.89	13.13	-2.76	13.11	-2.78	14.19	16.05	0.000869	1.86	104.18	33.95	0.33
confluenza	8	T=50	100.00	10.36	14.53	13.13	-1.40	13.11	-1.42	12.36	14.59	0.000385	1.18	89.31	32.59	0.21
confluenza	8	T=200	150.00	10.36	15.43	13.13	-2.30	13.11	-2.32	12.83	15.52	0.000354	1.34	119.95	33.95	0.21
confluenza	8	T=500	180.00	10.36	15.93	13.13	-2.80	13.11	-2.82	13.09	16.03	0.000339	1.42	136.94	33.95	0.21
confluenza	7	T=50	100.00	10.80	14.51	13.24	-1.27	13.06	-1.45	12.84	14.59	0.000582	1.29	81.86	33.68	0.25
confluenza	7	T=200	150.00	10.80	15.42	13.24	-2.18	13.06	-2.36	13.30	15.51	0.000494	1.41	112.54	33.68	0.24
confluenza	7	T=500	180.00	10.80	15.92	13.24	-2.68	13.06	-2.86	13.49	16.02	0.000464	1.47	129.45	33.68	0.23
confluenza	6	T=50	100.00	9.09	14.53	13.25	-1.28	13.06	-1.47	11.60	14.58	0.000253	1.00	105.04	33.68	0.17
confluenza	6	T=200	150.00	9.09	15.44	13.25	-2.19	13.06	-2.38	12.13	15.51	0.000266	1.17	135.66	33.68	0.18
confluenza	6	T=500	180.00	9.09	15.94	13.25	-2.69	13.06	-2.88	12.40	16.02	0.000270	1.25	152.55	33.68	0.18
confluenza	5	T=50	100.00	10.38	13.48	12.33	-1.15	12.52	-0.96	13.48	14.44	0.009577	4.56	24.68	12.85	0.89
confluenza	5	T=200	150.00	10.38	14.07	12.33	-1.74	12.52	-1.55	14.07	15.33	0.009930	5.31	32.28	12.85	0.94
confluenza	5	T=500	180.00	10.38	14.38	12.33	-2.05	12.52	-1.86	14.38	15.83	0.010142	5.70	36.30	12.85	0.97
confluenza	4	T=50	100.00	7.92	11.63	9.58	-2.05	9.65	-1.98	10.63	11.94	0.002197	2.68	44.65	18.11	0.47
confluenza	4	T=200	150.00	7.92	12.77	9.58	-3.19	9.65	-3.12	11.21	13.09	0.001590	2.78	65.31	18.11	0.42
confluenza	4	T=500	180.00	7.92	13.30	9.58	-3.72	9.65	-3.65	11.47	13.65	0.001521	2.94	74.85	18.11	0.42
confluenza	3	T=50	100.00	7.17	11.72	9.87	-1.85	10.19	-1.53	9.03	11.79	0.000347	1.22	87.18	24.90	0.19

HEC-RAS Plan: attuale_sett_17 River: Giustenice Reach: confluenza (Continued)

Reach	River Sta	Profile	Q Total (m3/s)	Min Ch El (m)	W.S. Elev (m)	LOB Elev (m)	L. Freeboard (m)	ROB Elev (m)	R. Freeboard (m)	Crit W.S. (m)	E.G. Elev (m)	E.G. Slope (m/m)	Vel Chnl (m/s)	Flow Area (m2)	Top Width (m)	Froude # Chl
confluenza	3	T=200	150.00	7.17	12.87	9.87	-3.00	10.19	-2.68	9.48	12.96	0.000328	1.40	115.84	24.90	0.20
confluenza	3	T=500	180.00	7.17	13.41	9.87	-3.54	10.19	-3.22	9.72	13.52	0.000337	1.52	129.28	24.90	0.20
confluenza	2.5	Bridge														
confluenza	2	T=50	100.00	7.36	11.02	9.87	-1.15	9.44	-1.58	8.98	11.09	0.000459	1.26	88.79	39.76	0.22
confluenza	2	T=200	150.00	7.36	11.95	9.87	-2.08	9.44	-2.51	9.40	12.03	0.000377	1.35	125.88	39.76	0.21
confluenza	2	T=500	180.00	7.36	12.57	9.87	-2.70	9.44	-3.13	9.65	12.65	0.000318	1.36	150.48	39.76	0.20
confluenza	1	T=50	100.00	6.60	10.98	8.64	-2.34	9.77	-1.21	8.91	11.07	0.000511	1.42	84.63	42.49	0.24
confluenza	1	T=200	150.00	6.60	11.93	8.64	-3.29	9.77	-2.16	9.40	12.02	0.000403	1.48	124.72	42.49	0.22
confluenza	1	T=500	180.00	6.60	12.55	8.64	-3.91	9.77	-2.78	9.65	12.64	0.000331	1.46	151.29	42.49	0.21

T. GIUSTENICE o SCARINCIO – tratto di monte

dalla SEZ. **23** (loc. Verrina, quota 50 m slm circa)
alla SEZ. **14** (loc. Fornace, quota 20 m slm circa)

- PROFILI DI RIGURGITO IN CONDIZIONI DI MOTO PERMANENTE PER LE PORTATE $T = 50, 200, 500$ ANNI

- GEOMETRIA DELLE SEZIONI ED ALTEZZA DEL PELO LIBERO IN CONDIZIONI DI MOTO PERMANENTE PER LE PORTATE $T = 50, 200, 500$ ANNI

- MODELLAZIONE IDRAULICA IN CONDIZIONI DI MOTO PERMANENTE:
TABELLE DELLE GRANDEZZE IDRAULICHE SIGNIFICATIVE PER LE PORTATE $T = 50, 200, 500$ ANNI

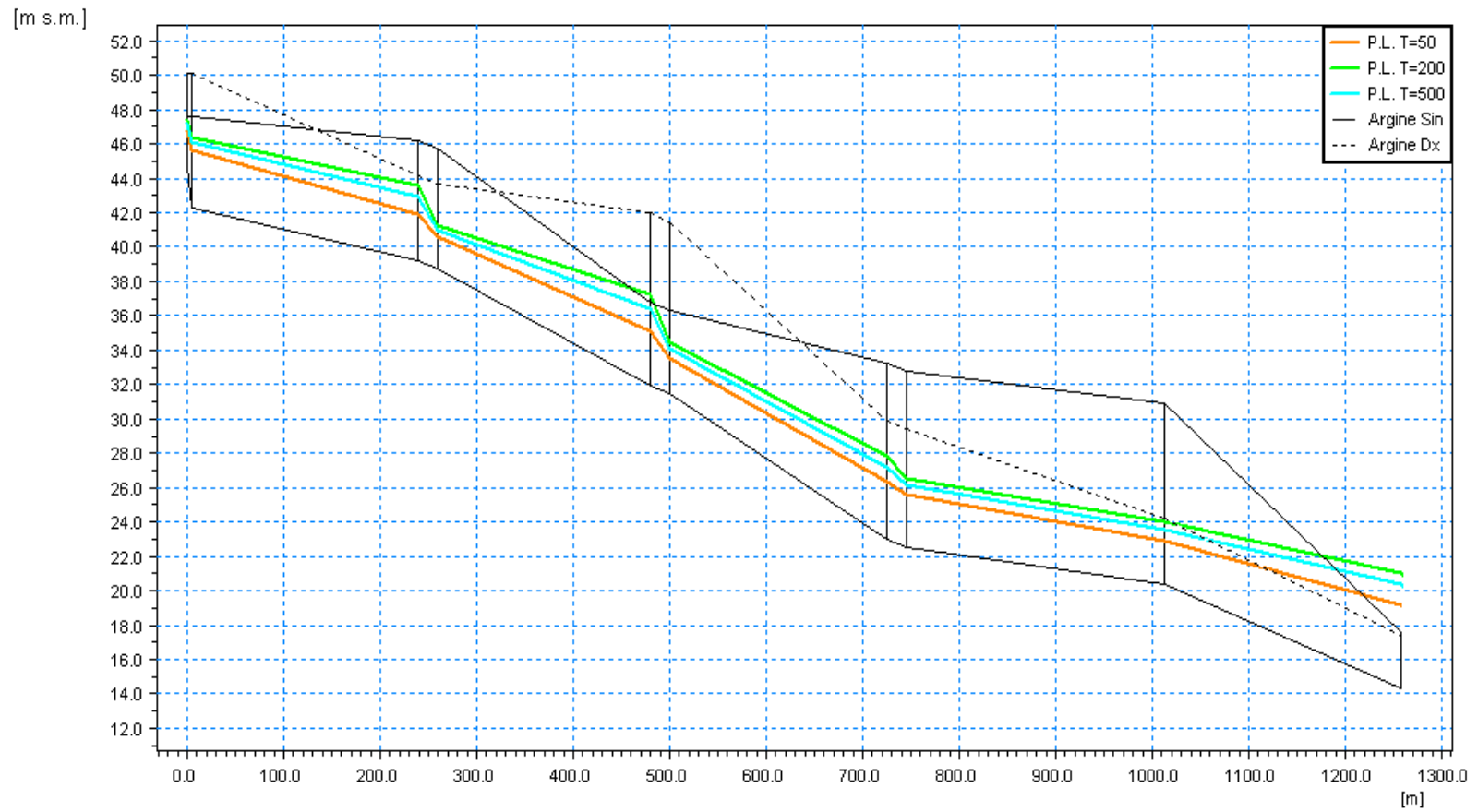

Progressiva	0.000	239.830	479.920	725.120	1013.220	1278.300
ID Sezione	23	21	19	17	15	14

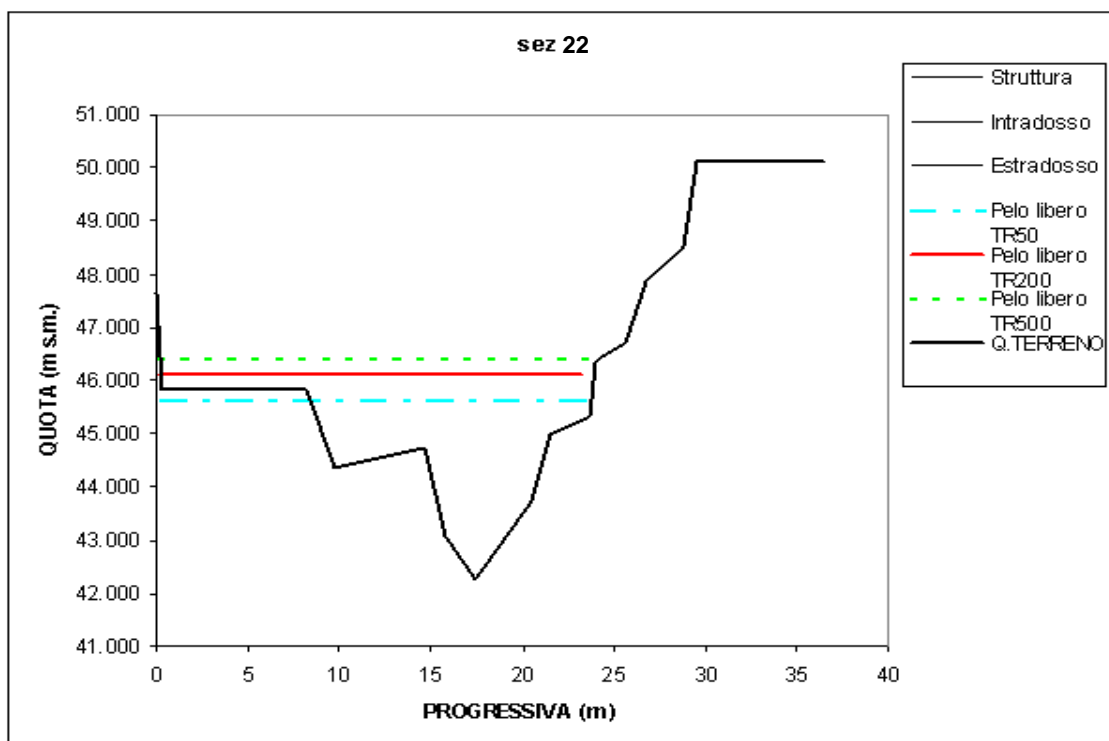
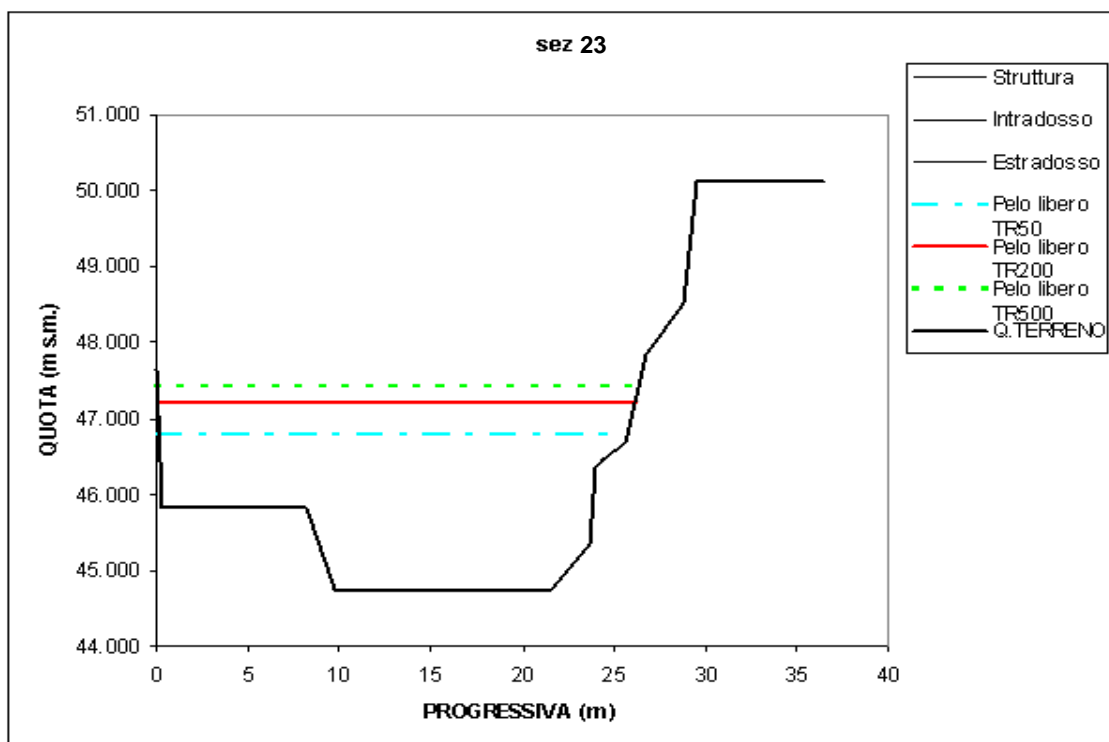

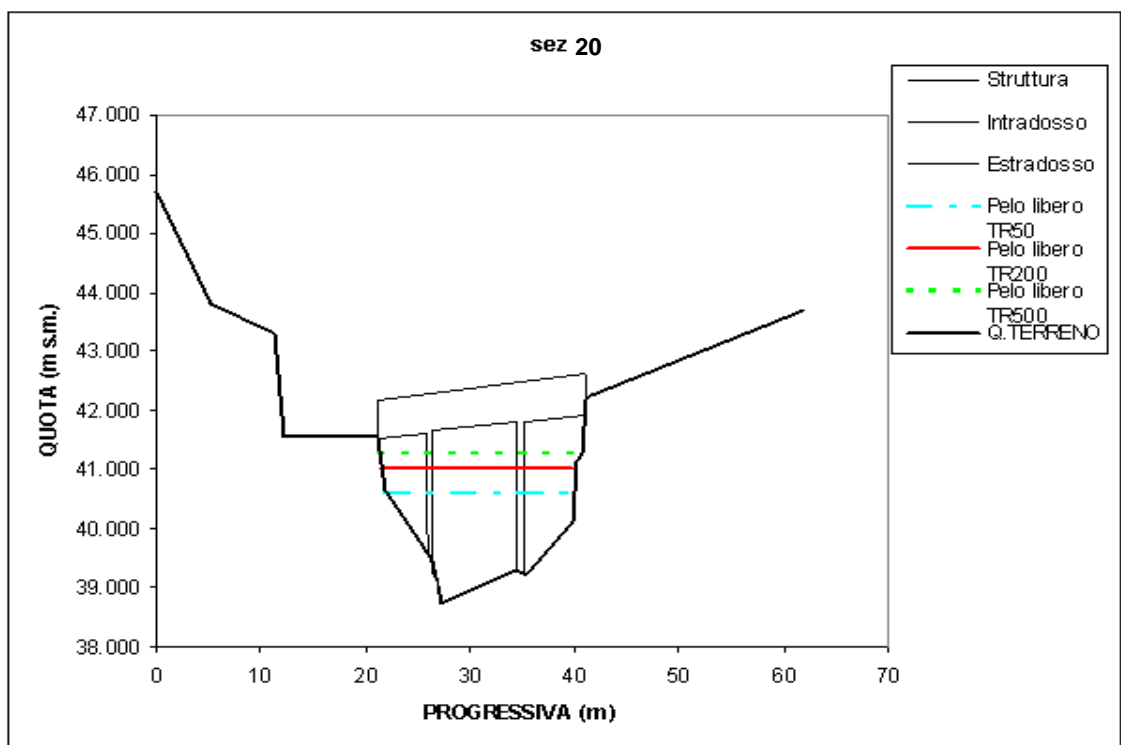
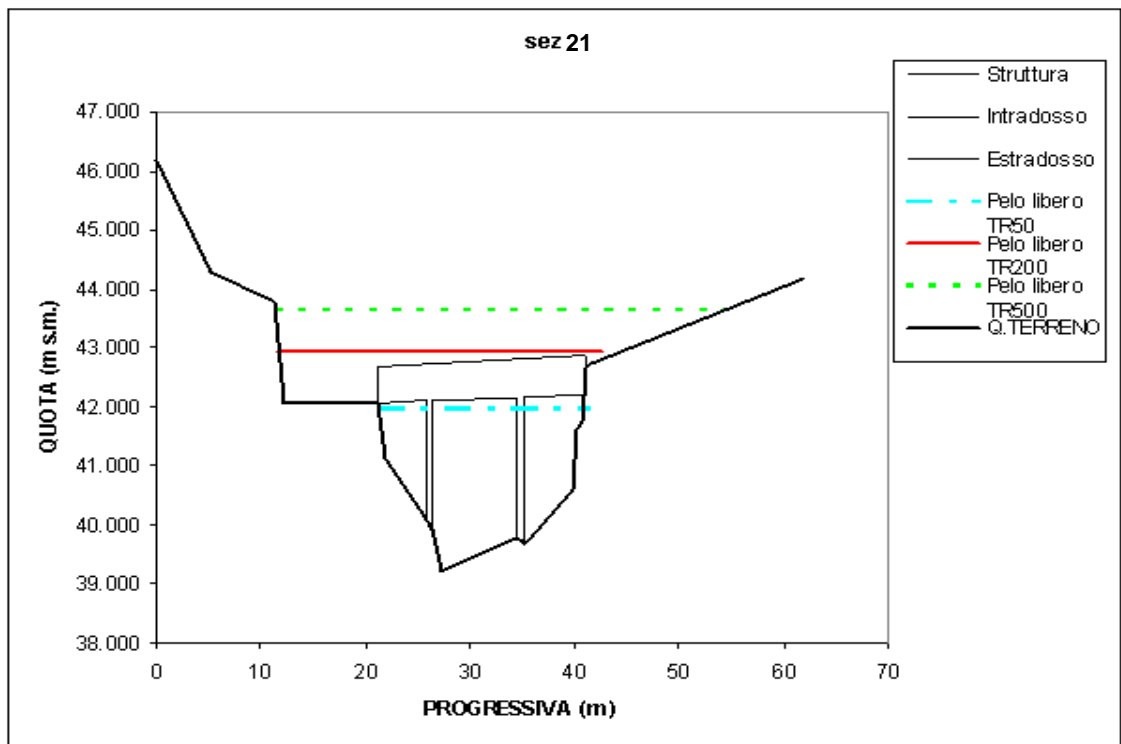

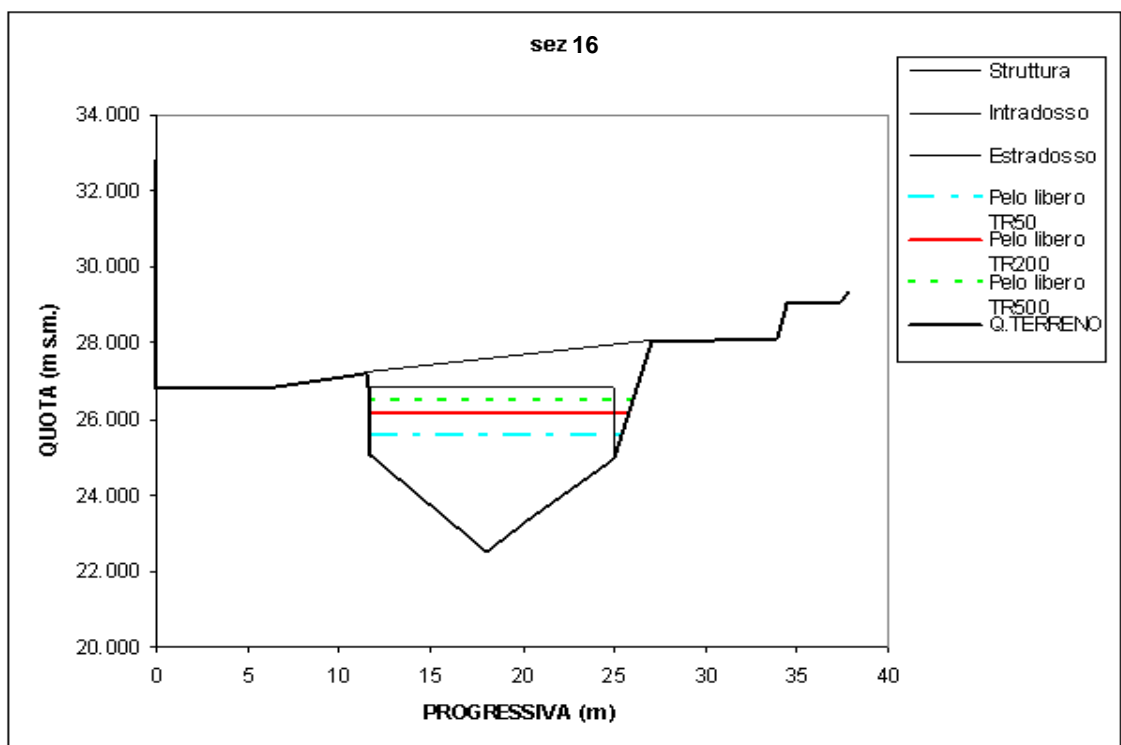
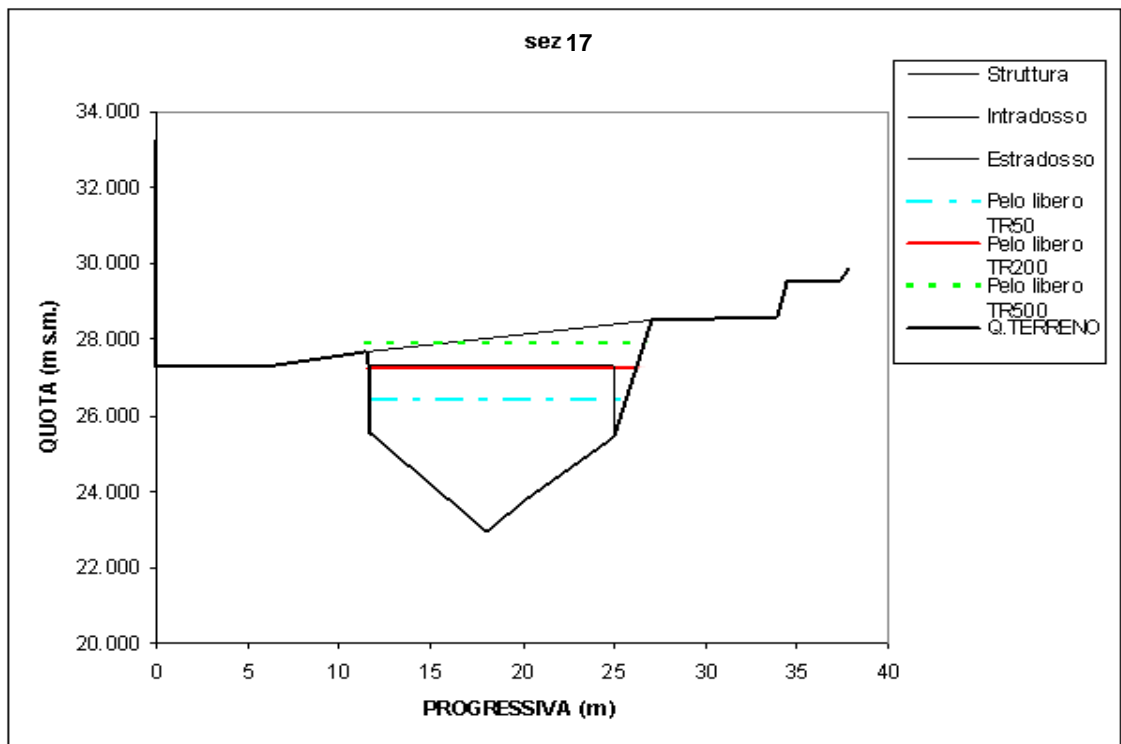

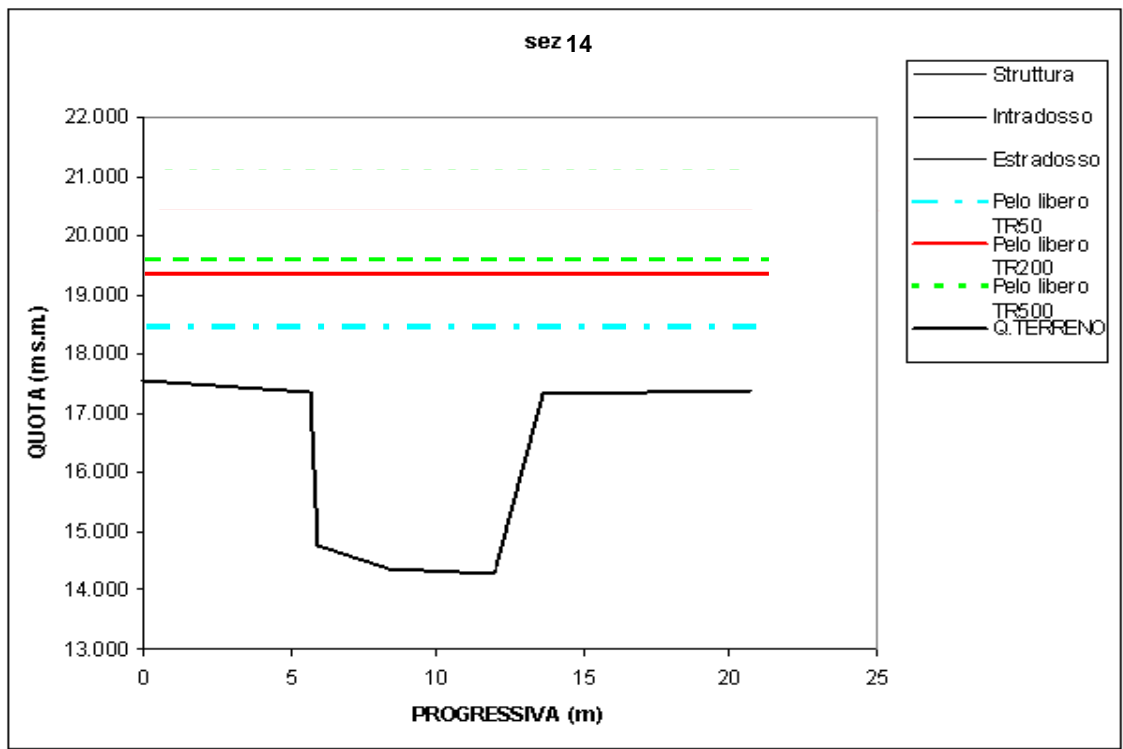
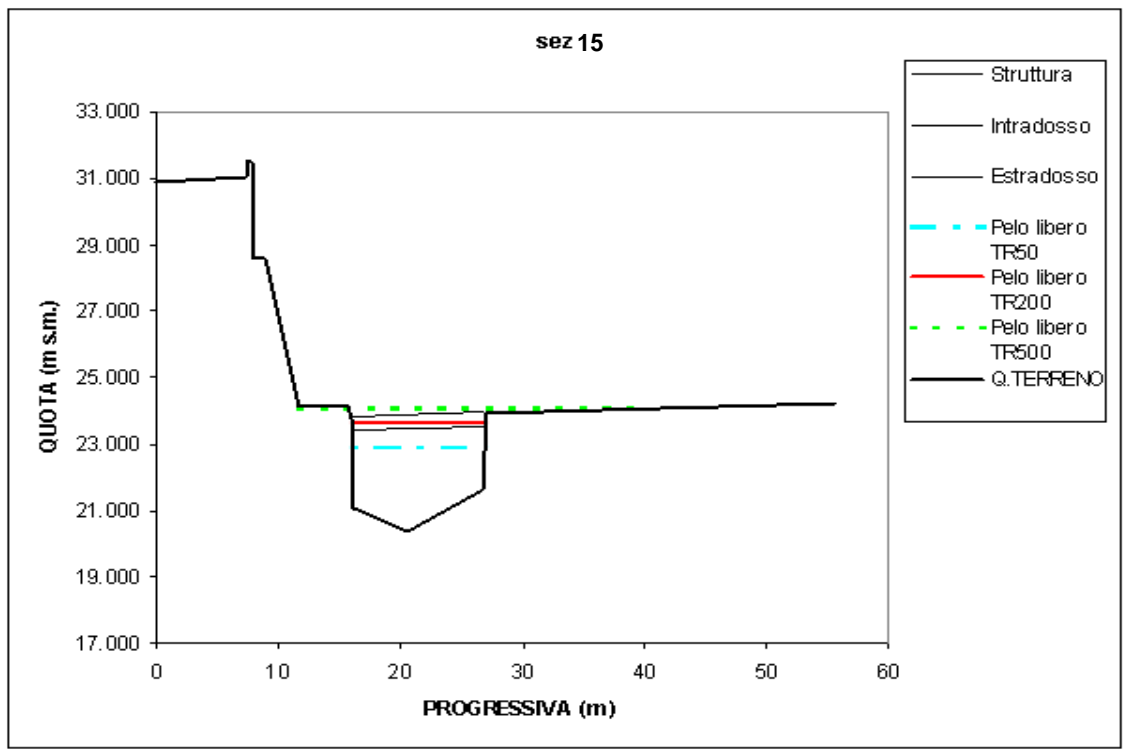

TORRENTE GIUSTENICE – PROFILO DI CORRENTE PER T=50 ANNI							
ID Sez.	Progr. (m)	Quota fondo (m s.m.)	P.L. (m s.m.)	A (m ²)	b (m)	v (m/s)	Fr (-)
23	0.00	44.73	46.78	38.31	25.58	2.61	0.68
22	4.00	42.27	45.60	22.85	15.25	4.38	1.14
21	239.83	39.23	41.95	36.64	21.88	2.73	0.67
20	259.83	38.75	40.59	20.12	17.79	4.97	1.49
19	479.92	31.95	35.11	26.20	10.51	3.82	0.77
18	499.92	31.47	33.50	15.40	9.13	6.49	1.60
17	725.12	22.97	26.38	28.92	13.97	3.46	0.77
16	745.12	22.49	25.58	24.45	13.74	4.09	0.98
15	1013.22	20.41	22.84	20.66	10.70	4.80	1.09
14	1257.30	13.80	18.53	53.66	20.72	1.86	0.37

Torrente Giustenice - Risultati delle simulazioni idrauliche – T = 50 anni

TORRENTE GIUSTENICE – PROFILO DI CORRENTE PER T=200 ANNI							
ID Sez.	Progr. (m)	Quota fondo (m s.m.)	P.L. (m s.m.)	A (m ²)	b (m)	v (m/s)	Fr (-)
23	0.00	44.73	47.20	49.20	26.10	3.05	0.71
22	4.00	42.27	46.11	32.81	23.67	4.57	1.24
21	239.83	39.23	42.95	65.36	32.90	2.30	0.52
20	259.83	38.75	41.01	27.74	18.48	5.41	1.41
19	479.92	31.95	36.43	47.31	22.41	3.17	0.70
18	499.92	31.47	34.07	20.66	9.37	7.26	1.56
17	725.12	22.97	27.21	40.78	14.90	3.68	0.71
16	745.12	22.49	26.17	32.72	14.17	4.58	0.96
15	1013.22	20.41	23.57	28.58	10.86	5.22	1.02
14	1257.30	13.80	19.30	69.58	20.72	2.16	0.38

Torrente Giustenice -Risultati delle simulazioni idrauliche – T = 200 anni

TORRENTE GIUSTENICE – PROFILO DI CORRENTE PER T=500 ANNI							
ID Sez.	Progr. (m)	Quota fondo (m s.m.)	P.L. (m s.m.)	A (m ²)	b (m)	v (m/s)	Fr (-)
23	0.00	44.73	47.42	54.96	26.36	3.28	0.72
22	4.00	42.27	46.40	39.77	24.09	4.53	1.12
21	239.83	39.23	43.63	90.94	42.96	1.98	0.43
20	259.83	38.75	41.27	32.67	19.15	5.51	1.35
19	479.92	31.95	37.21	64.94	22.55	2.77	0.52
18	499.92	31.47	34.43	24.13	10.03	7.46	1.54
17	725.12	22.97	27.87	56.04	26.58	3.21	0.71
16	745.12	22.49	26.51	37.55	14.42	4.80	0.95
15	1013.22	20.41	24.01	34.38	24.69	5.22	1.38
14	1257.30	13.80	19.65	76.80	20.72	2.37	0.39

Torrente Giustenice -Risultati delle simulazioni idrauliche – T = 500 anni

T. GIUSTENICE o SCARINCIO – loc. San Lorenzo

dalla SEZ. **1** (quota 120 m slm circa)
alla SEZ. **3** (quota 115 m slm circa)

- PROFILI DI RIGURGITO IN CONDIZIONI DI MOTO PERMANENTE PER LE PORTATE $T = 50, 200, 500$ ANNI

- GEOMETRIA DELLE SEZIONI ED ALTEZZA DEL PELO LIBERO IN CONDIZIONI DI MOTO PERMANENTE PER LE PORTATE $T = 50, 200, 500$ ANNI

- MODELLAZIONE IDRAULICA IN CONDIZIONI DI MOTO PERMANENTE:
TABELLE DELLE GRANDEZZE IDRAULICHE SIGNIFICATIVE PER LE PORTATE $T = 50, 200, 500$ ANNI

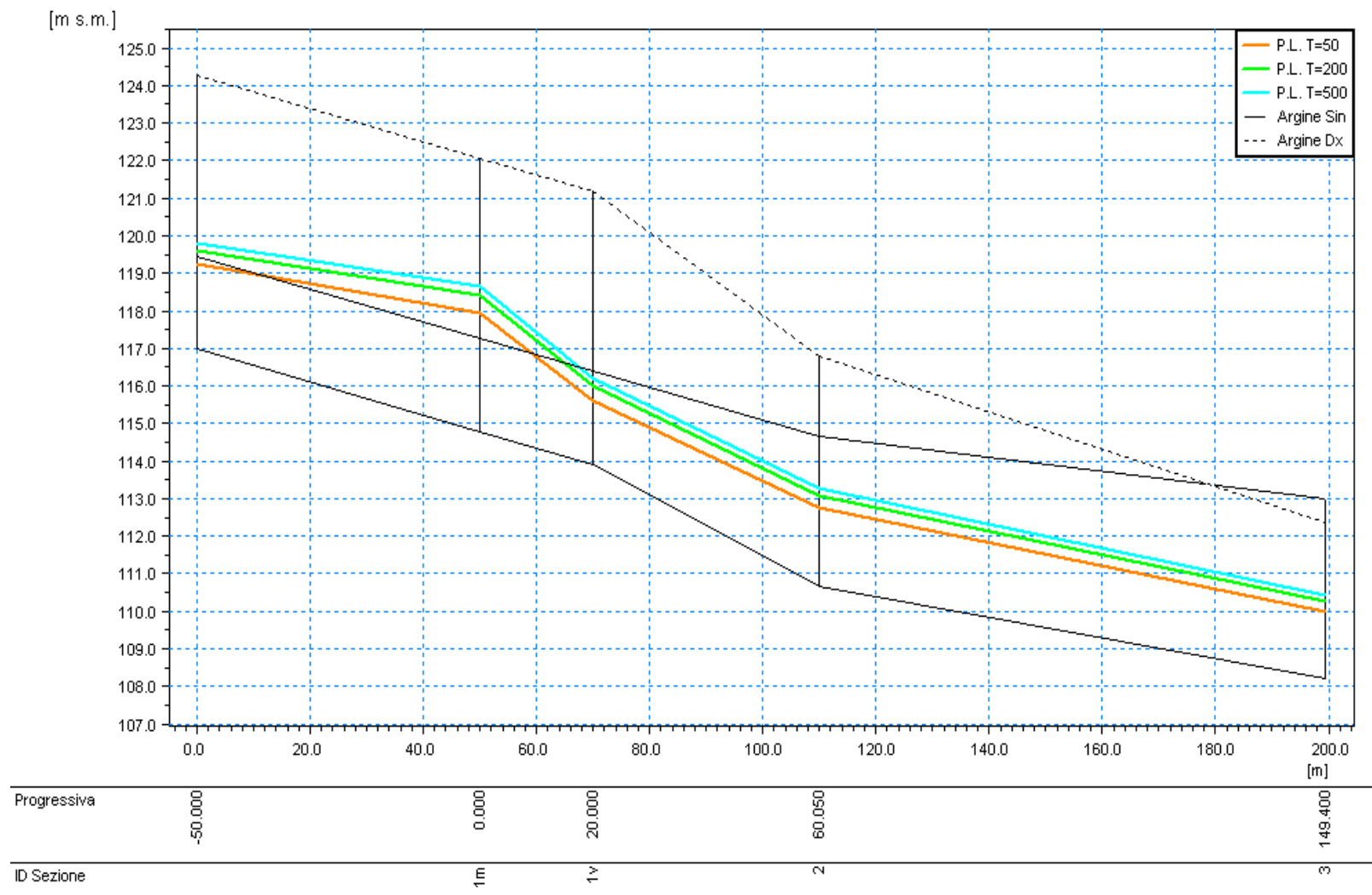

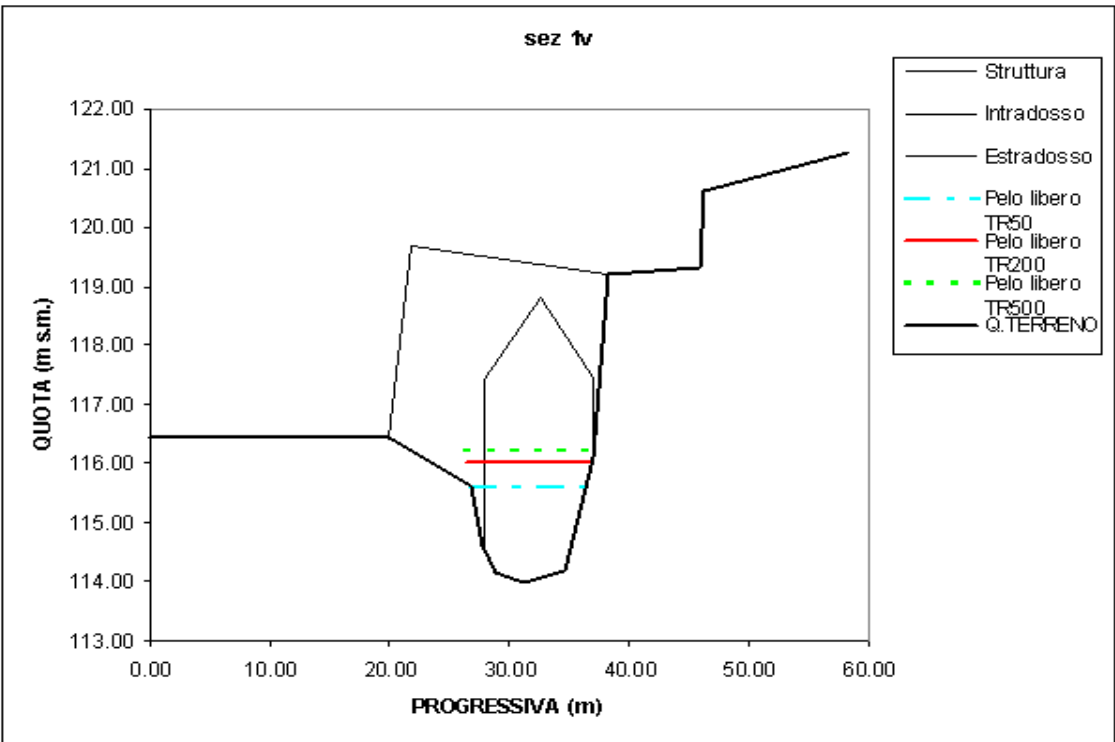
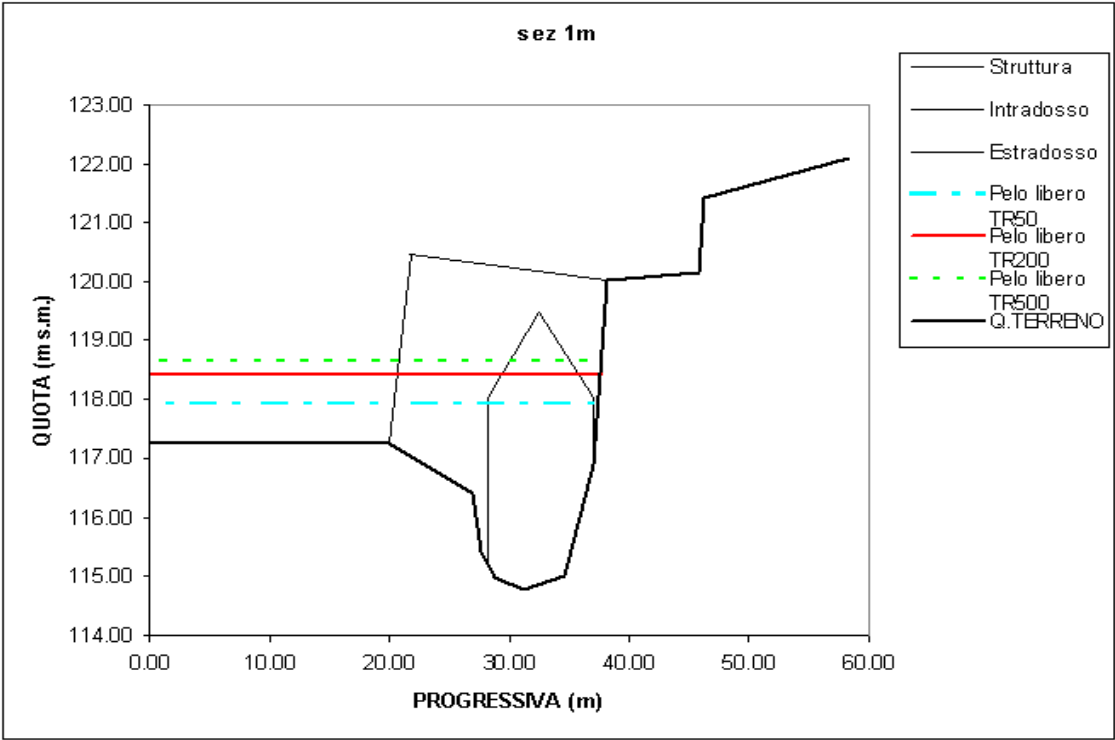

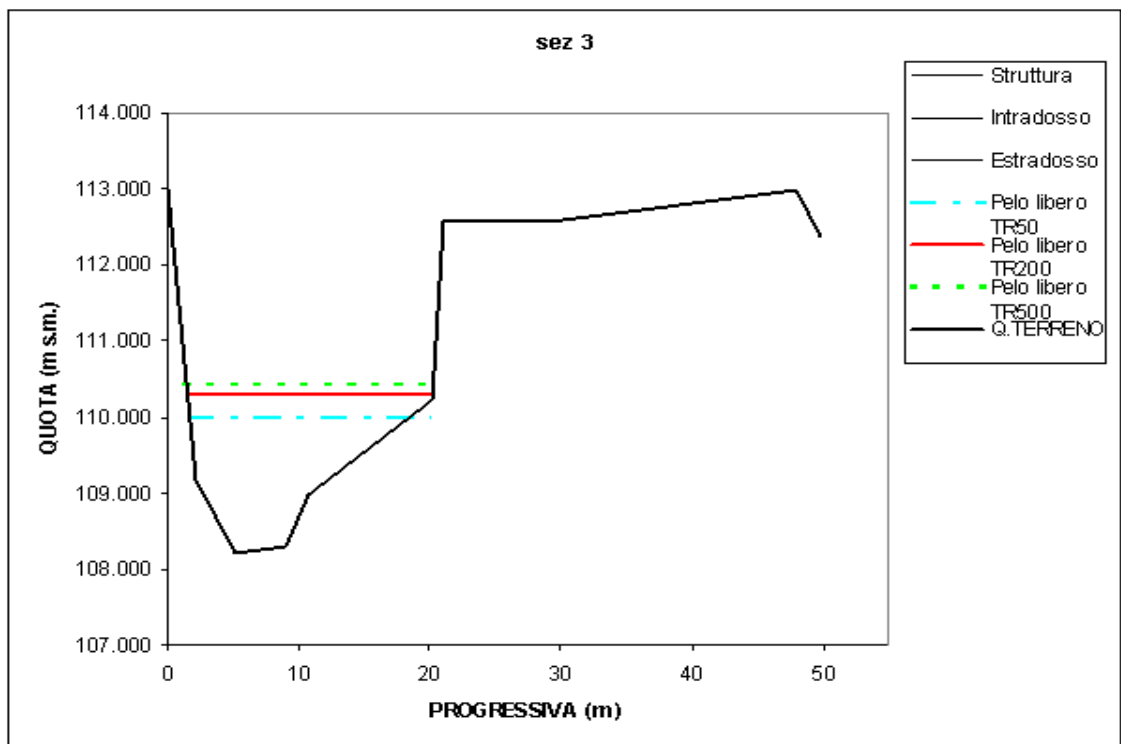
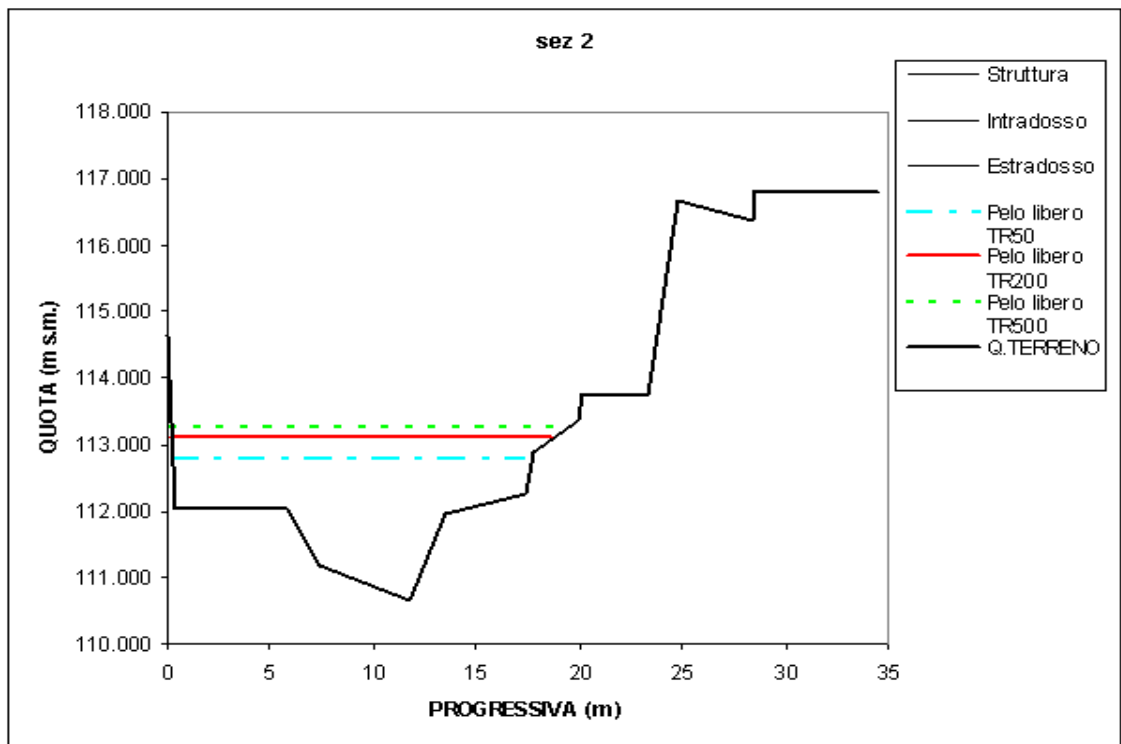

RIO GIUSTENICE – PROFILO DI CORRENTE PER T=50 ANNI							
ID Sez.	Progr. (m)	Quota fondo (m s.m.)	P.L. (m s.m.)	A (m ²)	b (m)	v (m/s)	Fr (-)
1m	0.00	114.78	117.93	48.32	37.48	1.82	0.51
1v	20.00	113.91	115.60	12.33	10.00	7.14	2.05
2	60.05	110.66	112.78	19.23	17.41	4.58	1.39
3	149.40	108.21	109.99	17.10	16.77	5.15	1.63

Rio Giustenice - Risultati delle simulazioni idrauliche – T = 50 anni

RIO GIUSTENICE – PROFILO DI CORRENTE PER T=200 ANNI							
ID Sez.	Progr. (m)	Quota fondo (m s.m.)	P.L. (m s.m.)	A (m ²)	b (m)	v (m/s)	Fr (-)
1m	0.00	114.78	118.40	65.74	37.65	1.95	0.47
1v	20.00	113.91	116.02	17.35	13.96	7.38	2.11
2	60.05	110.66	113.09	24.88	18.48	5.15	1.42
3	149.40	108.21	110.29	22.44	18.70	5.70	1.66

Rio Giustenice -Risultati delle simulazioni idrauliche – T = 200 anni

RIO GIUSTENICE – PROFILO DI CORRENTE PER T=500 ANNI							
ID Sez.	Progr. (m)	Quota fondo (m s.m.)	P.L. (m s.m.)	A (m ²)	b (m)	v (m/s)	Fr (-)
1m	0.00	114.78	118.66	75.65	37.75	2.04	0.46
1v	20.00	113.91	116.21	20.28	15.70	7.59	2.13
2	60.05	110.66	113.27	28.30	19.34	5.44	1.44
3	149.40	108.21	110.44	25.25	18.87	6.10	1.68

Rio Giustenice -Risultati delle simulazioni idrauliche – T = 500 anni

**RIO MOGLIE – affluente in sponda sinistra del T. Maremola,
in loc. Tovo San Giacomo**

dalla SEZ. **1** (quota 80 m slm circa)
alla SEZ. **4** (confluenza nel T. Maremola)

- PROFILI DI RIGURGITO IN CONDIZIONI DI MOTO PERMANENTE PER LE PORTATE $T = 50, 200, 500$ ANNI

- GEOMETRIA DELLE SEZIONI ED ALTEZZA DEL PELO LIBERO IN CONDIZIONI DI MOTO PERMANENTE PER LE PORTATE $T = 50, 200, 500$ ANNI

- MODELLAZIONE IDRAULICA IN CONDIZIONI DI MOTO PERMANENTE:
TABELLE DELLE GRANDEZZE IDRAULICHE SIGNIFICATIVE PER LE PORTATE $T = 50, 200, 500$ ANNI

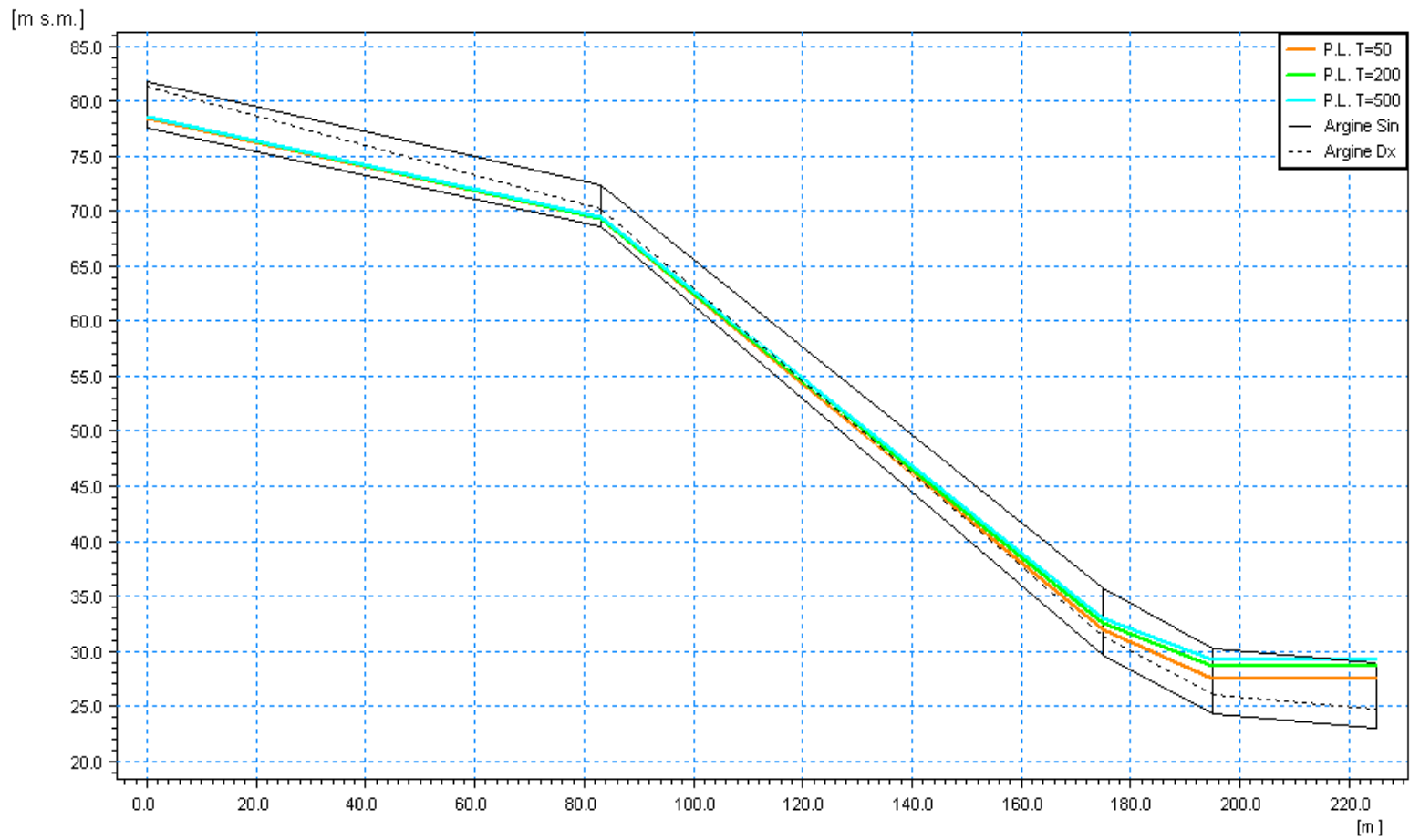

Progressiva	0.000	82.960	174.990	194.990	225.000
ID Sezione	1	2	3m	3v	

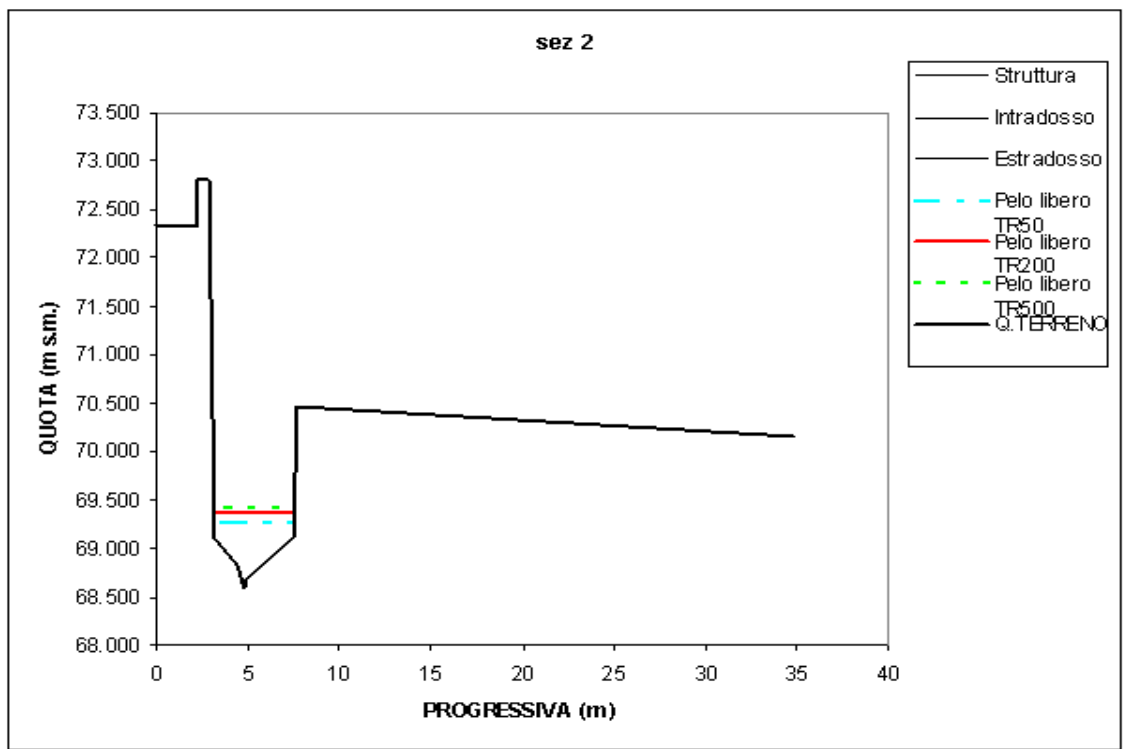
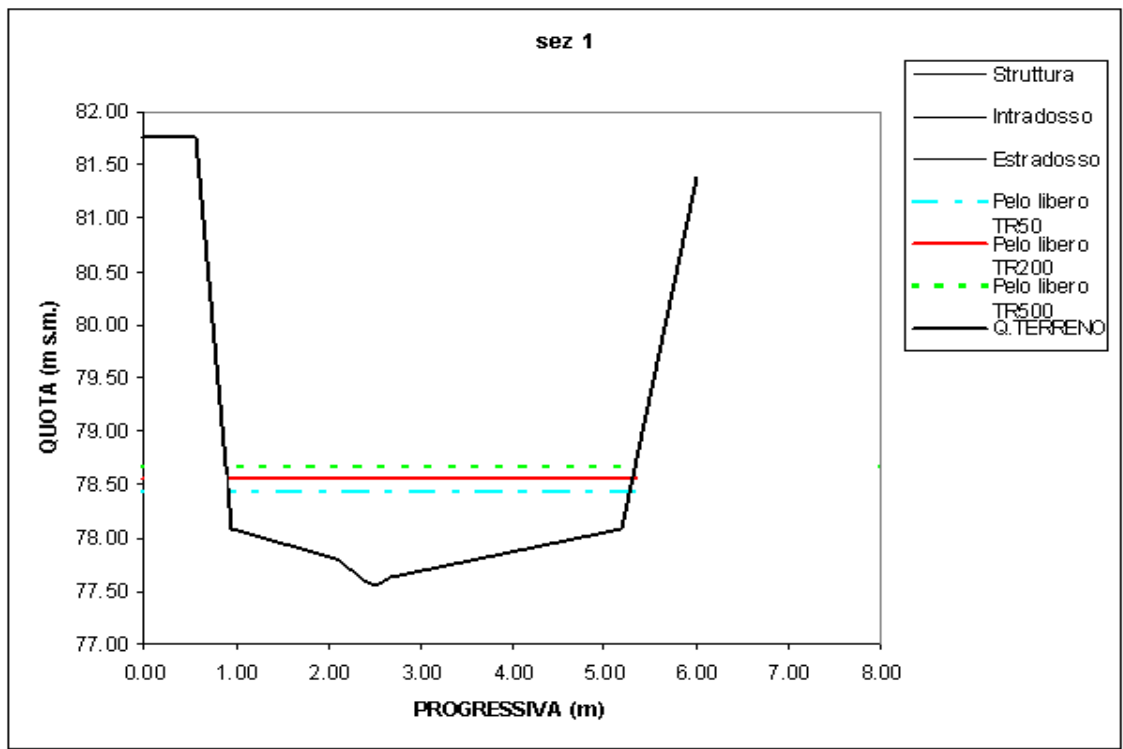

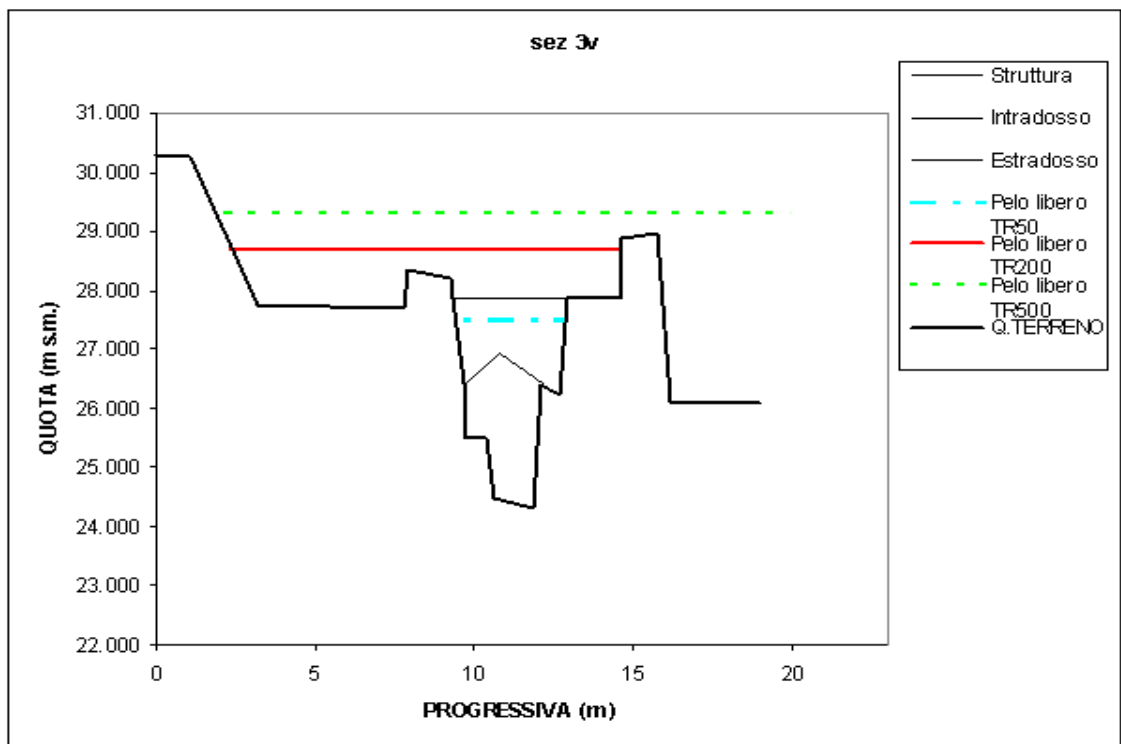
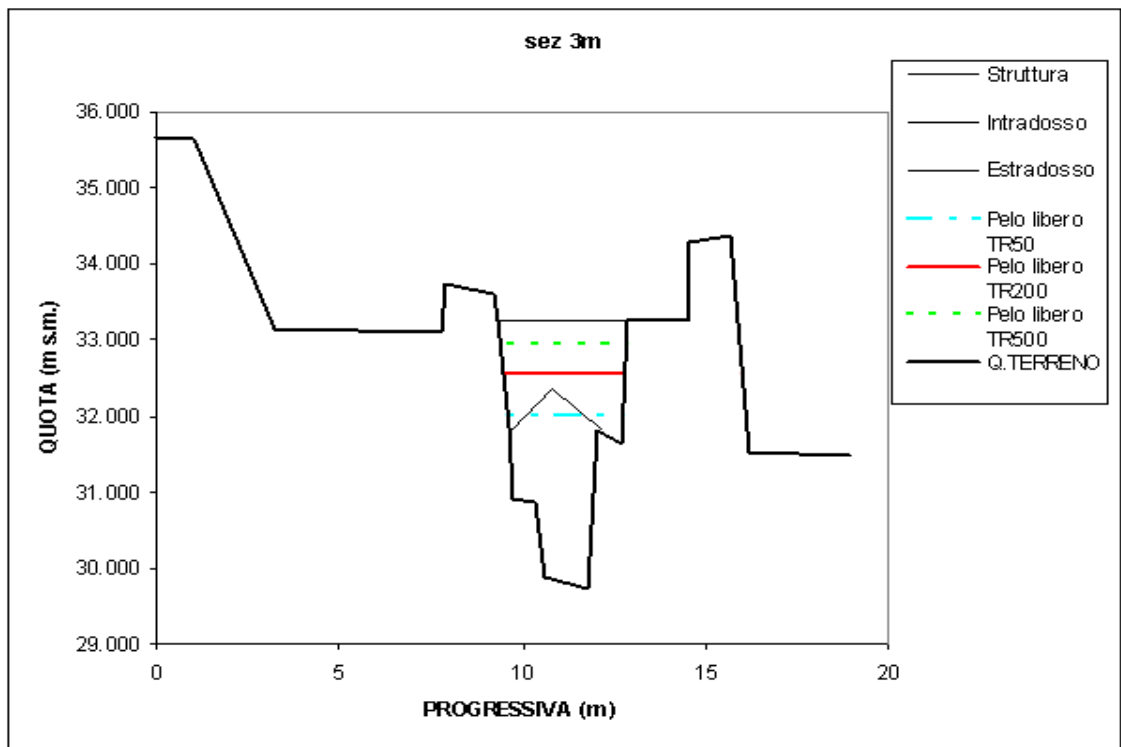

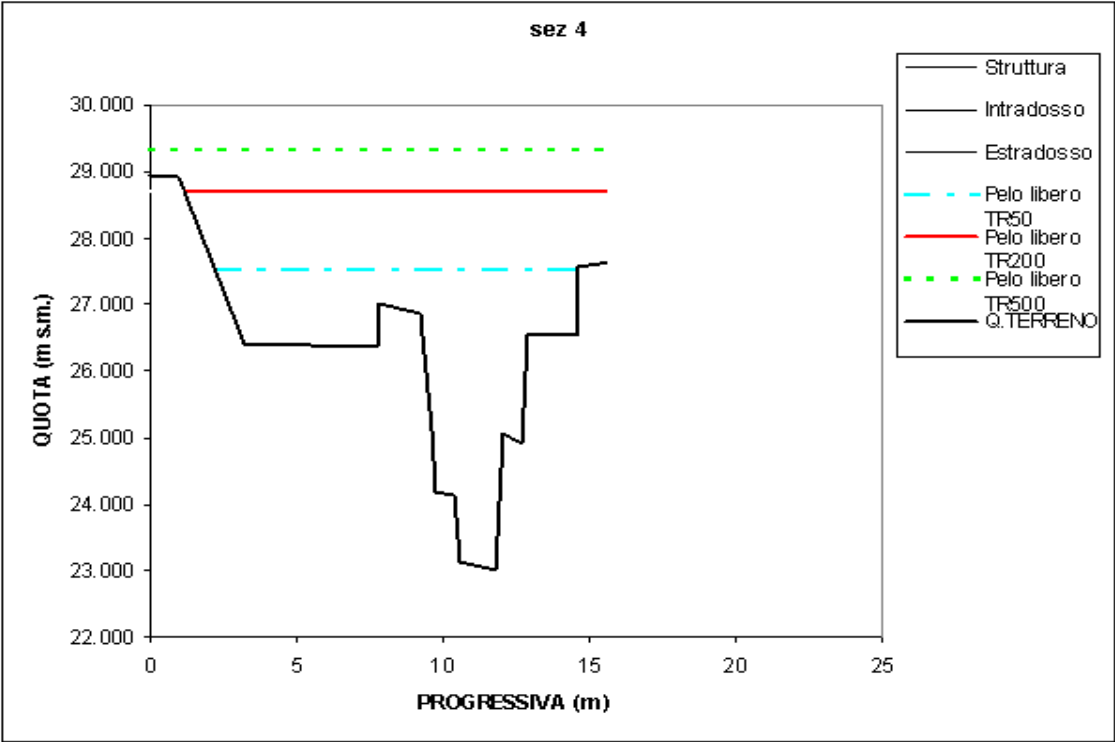

RIO MOGLIE – PROFILO DI CORRENTE PER T=50 ANNI							
ID Sez.	Progr. (m)	Quota fondo (m s.m.)	P.L. (m s.m.)	A (m ²)	b (m)	v (m/s)	Fr (-)
1	0.00	77.54	78.42	2.46	4.37	4.07	1.73
2	82.96	68.58	69.26	1.61	4.29	6.21	3.24
3m	174.99	29.73	32.02	5.81	5.98	1.72	0.56
3v	194.99	24.33	27.48	11.19	6.41	0.89	0.22
4	225.00	23.00	27.50	28.24	15.68	0.35	0.08

Rio Moglie - Risultati delle simulazioni idrauliche – T = 50 anni

RIO MOGLIE – PROFILO DI CORRENTE PER T=200 ANNI							
ID Sez.	Progr. (m)	Quota fondo (m s.m.)	P.L. (m s.m.)	A (m ²)	b (m)	v (m/s)	Fr (-)
1	0.00	77.54	78.56	3.07	4.42	4.56	1.75
2	82.96	68.58	69.36	2.01	4.32	6.97	3.27
3m	174.99	29.73	32.55	9.07	6.24	1.54	0.41
3v	194.99	24.33	28.69	26.14	15.43	0.54	0.13
4	225.00	23.00	28.70	48.79	17.75	0.29	0.06

Rio Moglie -Risultati delle simulazioni idrauliche – T = 200 anni

RIO MOGLIE – PROFILO DI CORRENTE PER T=500 ANNI							
ID Sez.	Progr. (m)	Quota fondo (m s.m.)	P.L. (m s.m.)	A (m ²)	b (m)	v (m/s)	Fr (-)
1	0.00	77.54	78.65	3.49	4.45	4.87	1.76
2	82.96	68.58	69.42	2.29	4.34	7.44	3.27
3m	174.99	29.73	32.93	11.51	6.44	1.48	0.35
3v	194.99	24.33	29.30	36.00	17.10	0.47	0.10
4	225.00	23.00	29.30	59.91	18.97	0.28	0.05

Rio Moglie -Risultati delle simulazioni idrauliche – T = 500 anni

**RIO RIVA ROCCA – affluente in sponda destra del T. Maremola,
in loc. Tovo San Giacomo**

dalla SEZ. **1** (quota 50 m slm circa)
alla SEZ. **4** (confluenza nel T. Maremola)

- PROFILI DI RIGURGITO IN CONDIZIONI DI MOTO PERMANENTE PER LE PORTATE $T = 50, 200, 500$ ANNI

- GEOMETRIA DELLE SEZIONI ED ALTEZZA DEL PELO LIBERO IN CONDIZIONI DI MOTO PERMANENTE PER LE PORTATE $T = 50, 200, 500$ ANNI

- MODELLAZIONE IDRAULICA IN CONDIZIONI DI MOTO PERMANENTE:
TABELLE DELLE GRANDEZZE IDRAULICHE SIGNIFICATIVE PER LE PORTATE $T = 50, 200, 500$ ANNI

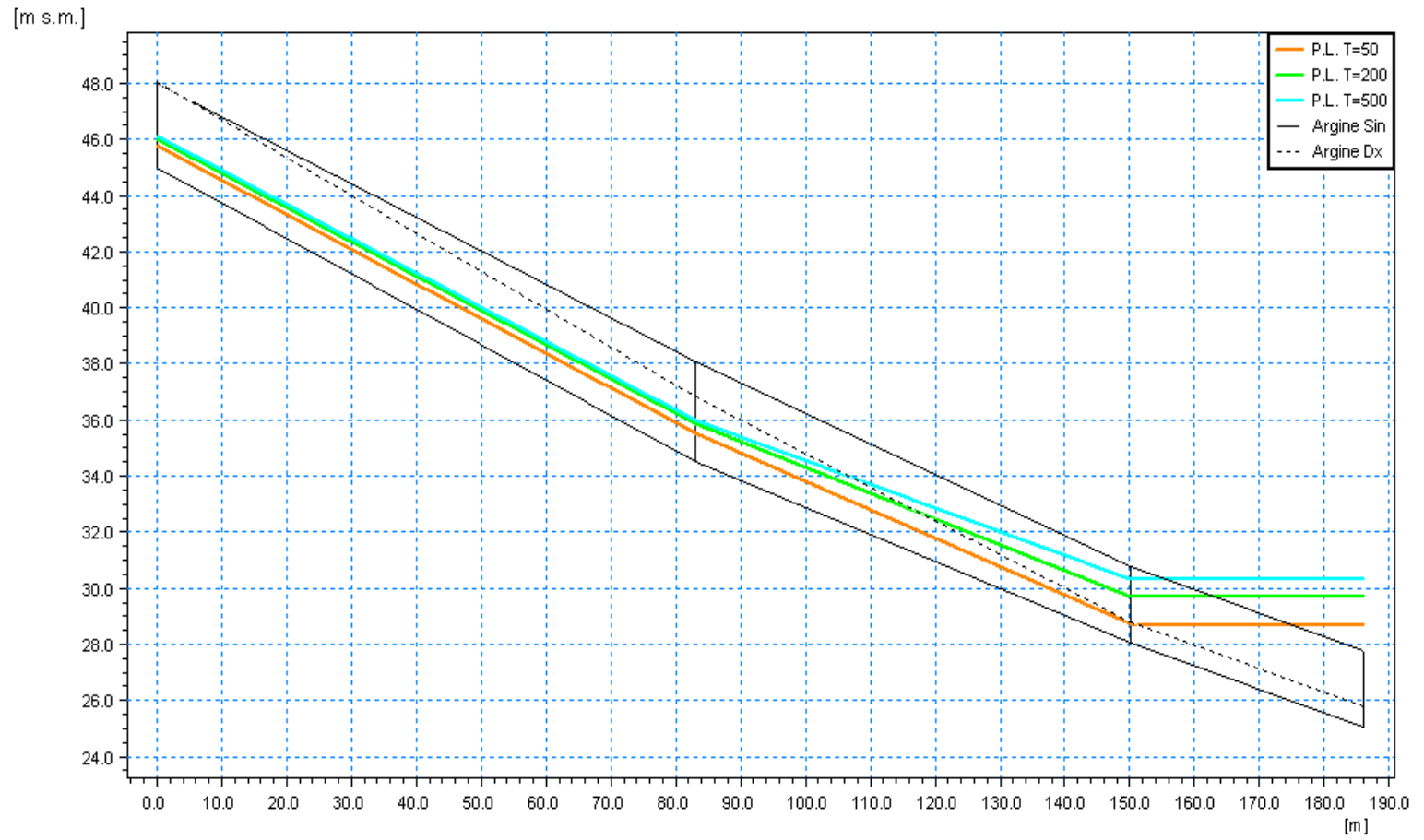

Progressiva	0.000	82.960	150.070	186.070
ID Sezione	1	2	3	

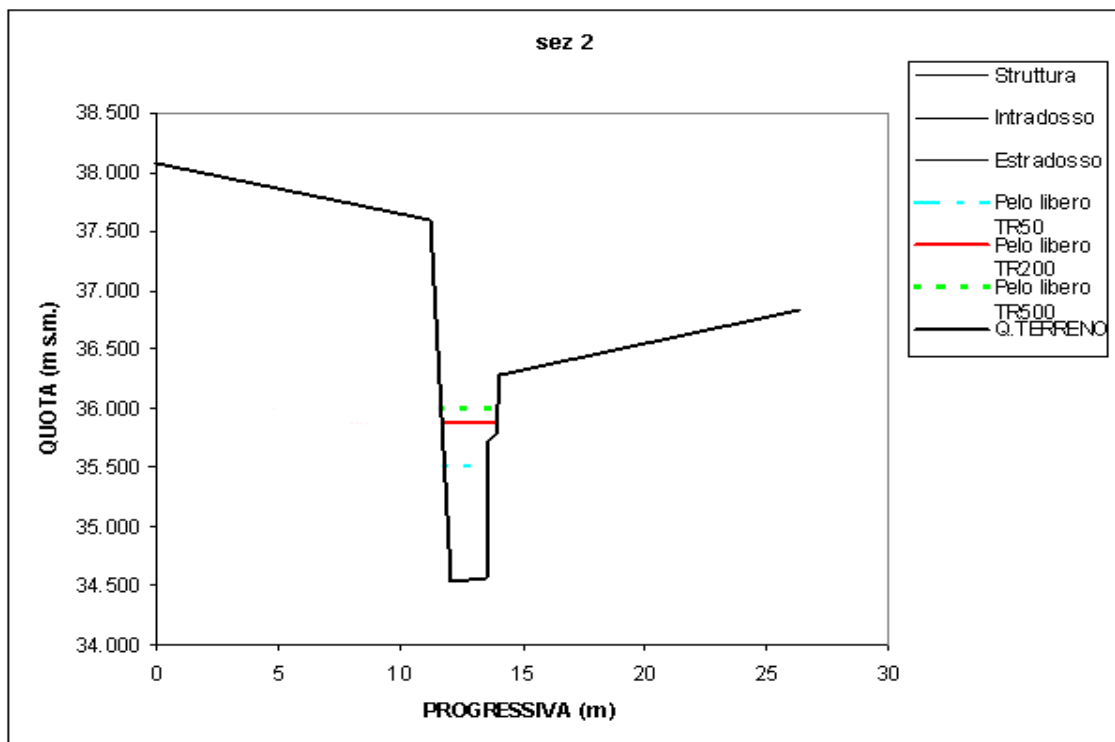
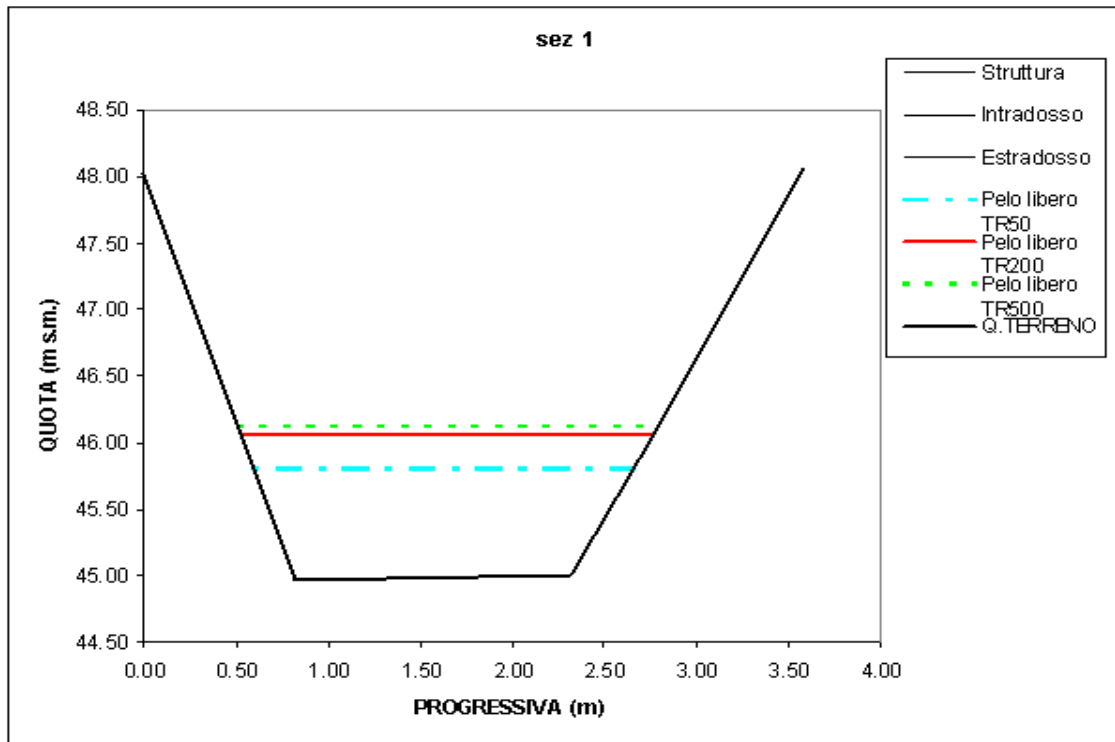

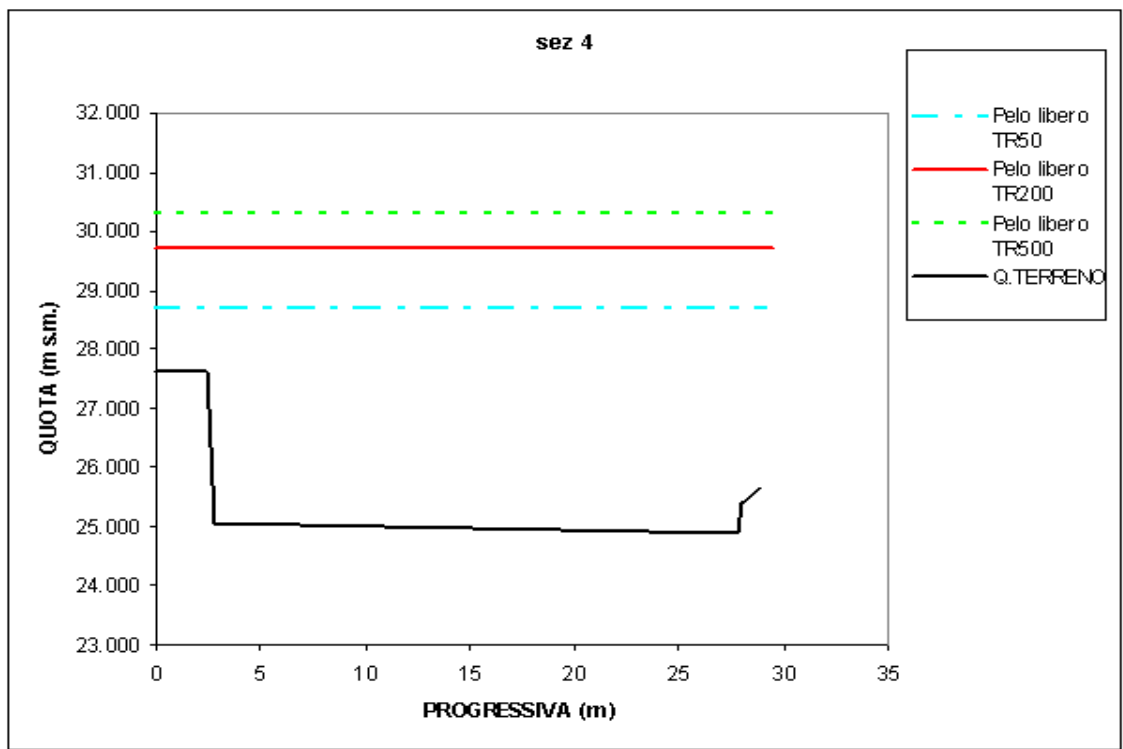
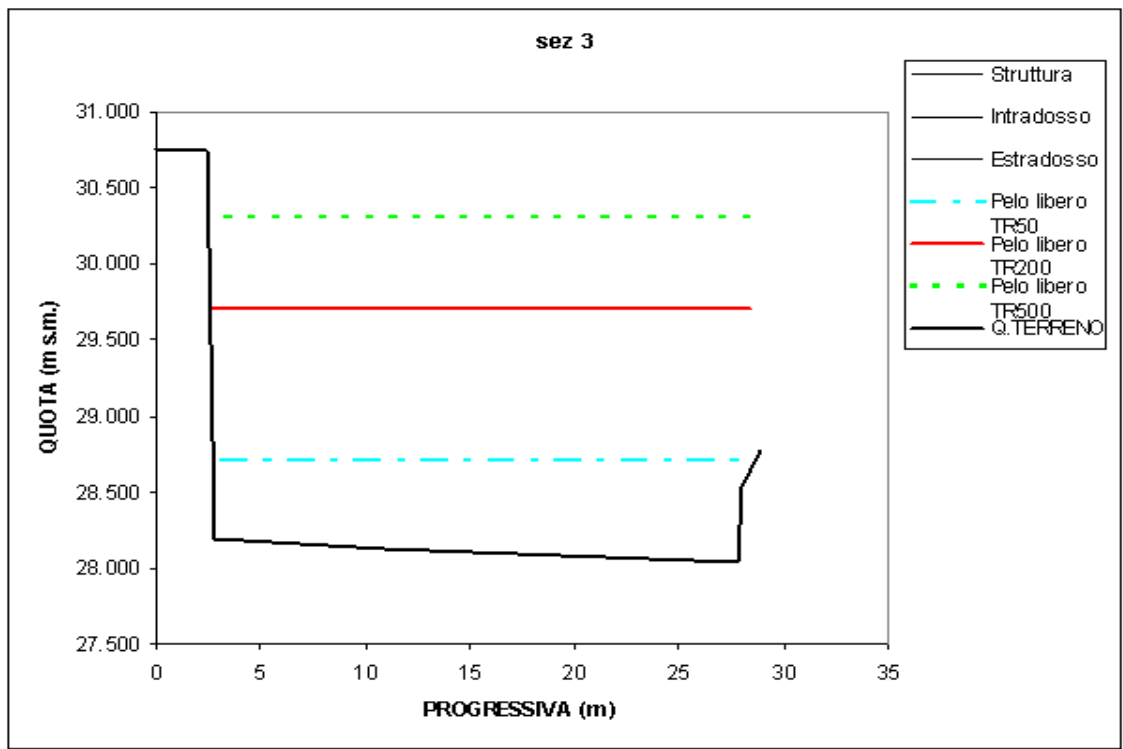

RIO RIVA-ROCCA – PROFILO DI CORRENTE PER T=50 ANNI							
ID Sez.	Progr. (m)	Quota fondo (m s.m.)	P.L. (m s.m.)	A (m ²)	b (m)	v (m/s)	Fr (-)
1	0.00	44.97	45.80	1.45	2.06	4.13	1.57
2	89.84	34.54	35.51	1.58	1.80	3.79	1.29
3	150.07	28.05	28.71	15.08	25.98	0.40	0.17
4	186.07	25.00	28.70	96.24	28.93	0.06	0.01

Rio Riva-Rocca - Risultati delle simulazioni idrauliche – T = 50 anni

RIO RIVA-ROCCA – PROFILO DI CORRENTE PER T=200 ANNI							
ID Sez.	Progr. (m)	Quota fondo (m s.m.)	P.L. (m s.m.)	A (m ²)	b (m)	v (m/s)	Fr (-)
1	0.00	44.97	46.05	1.97	2.22	4.56	1.55
2	89.84	34.54	35.88	2.31	2.26	3.90	1.23
3	150.07	28.05	29.70	41.06	26.33	0.22	0.06
4	186.07	25.00	29.70	125.17	28.93	0.07	0.01

Rio Riva-Rocca -Risultati delle simulazioni idrauliche – T = 200 anni

RIO RIVA-ROCCA – PROFILO DI CORRENTE PER T=500 ANNI							
ID Sez.	Progr. (m)	Quota fondo (m s.m.)	P.L. (m s.m.)	A (m ²)	b (m)	v (m/s)	Fr (-)
1	0.00	44.97	46.12	2.14	2.27	4.68	1.54
2	89.84	34.54	36.00	2.57	2.33	3.89	1.18
3	150.07	28.05	30.30	56.87	26.40	0.18	0.04
4	186.07	25.00	30.30	142.53	28.93	0.07	0.01

Rio Riva-Rocca -Risultati delle simulazioni idrauliche – T = 500 anni

**RIO CASELLO – affluente in sponda sinistra del T. Maremola,
in loc. Tovo San Giacomo**

dalla SEZ. **1** (quota 65 m slm circa)
alla SEZ. **5** (confluenza nel T. Maremola)

- PROFILI DI RIGURGITO IN CONDIZIONI DI MOTO PERMANENTE PER LE PORTATE $T = 50, 200, 500$ ANNI

- GEOMETRIA DELLE SEZIONI ED ALTEZZA DEL PELO LIBERO IN CONDIZIONI DI MOTO PERMANENTE PER LE PORTATE $T = 50, 200, 500$ ANNI

- MODELLAZIONE IDRAULICA IN CONDIZIONI DI MOTO PERMANENTE:
TABELLE DELLE GRANDEZZE IDRAULICHE
SIGNIFICATIVE PER LE PORTATE $T = 50, 200, 500$ ANNI

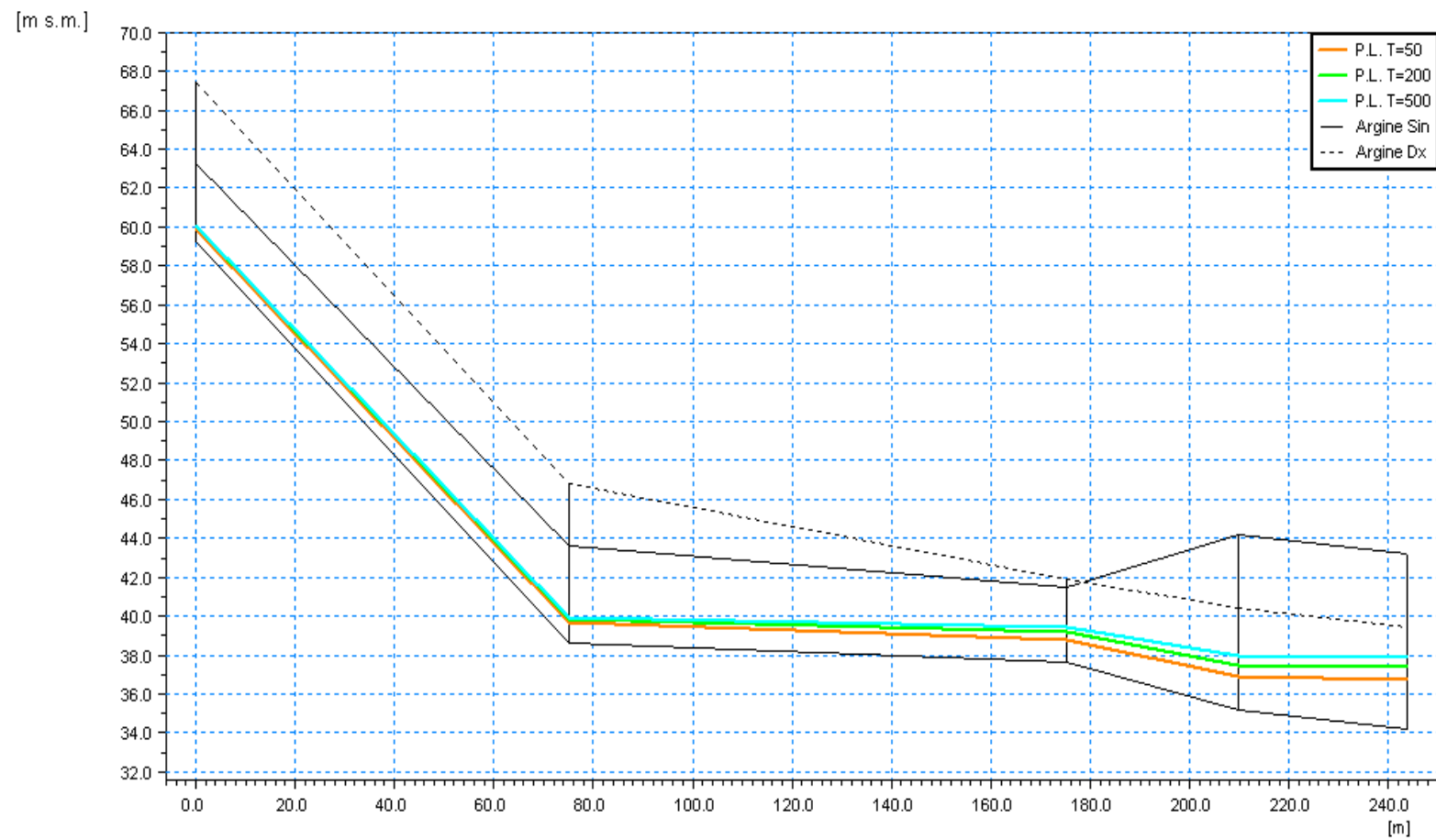

Progressiva	0.000	75.190	175.240	209.790	243.790
ID Sezione	1	2	3	4	

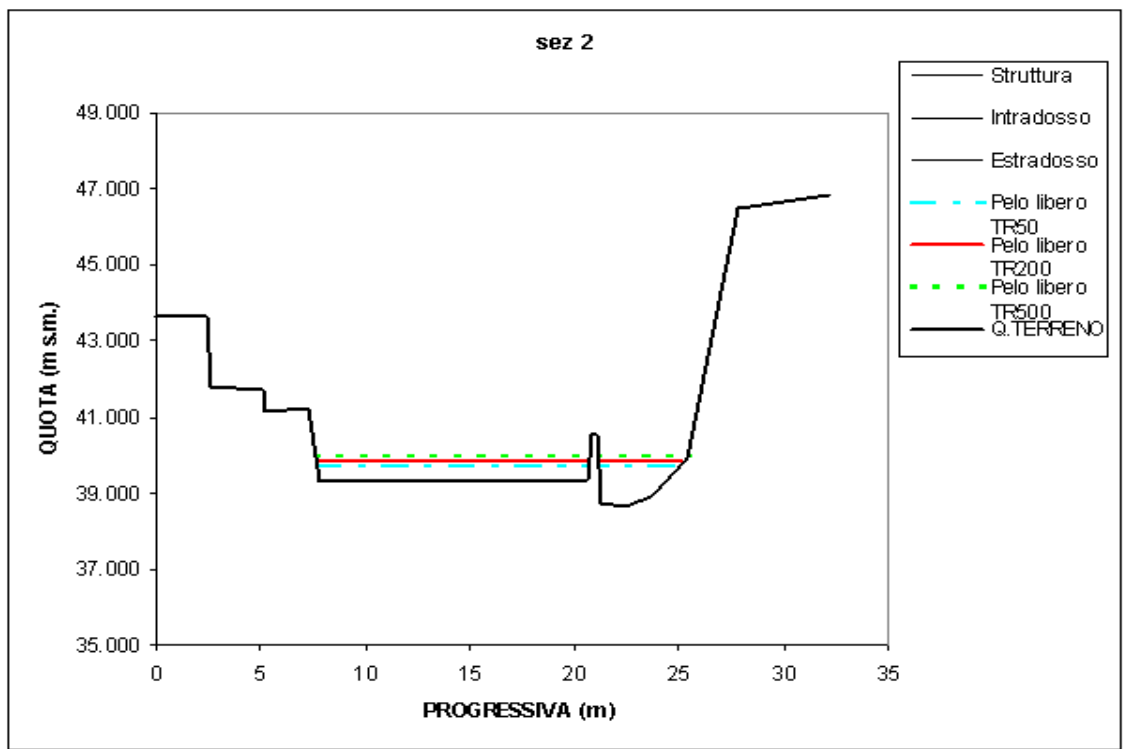
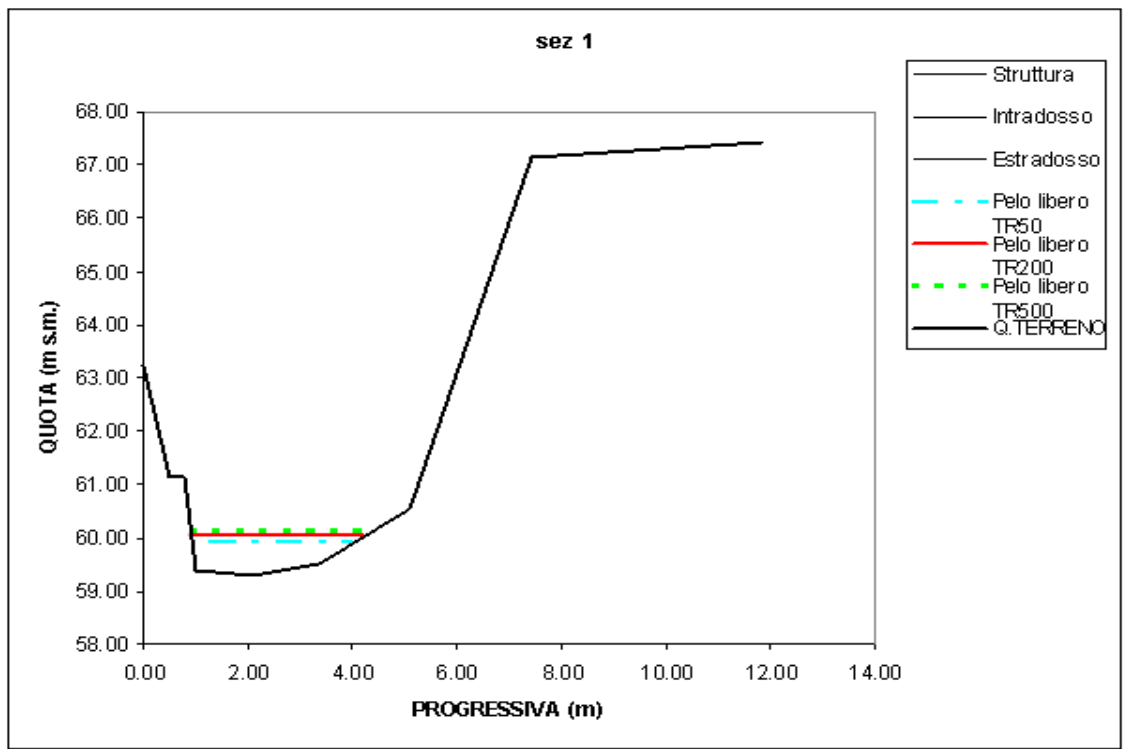

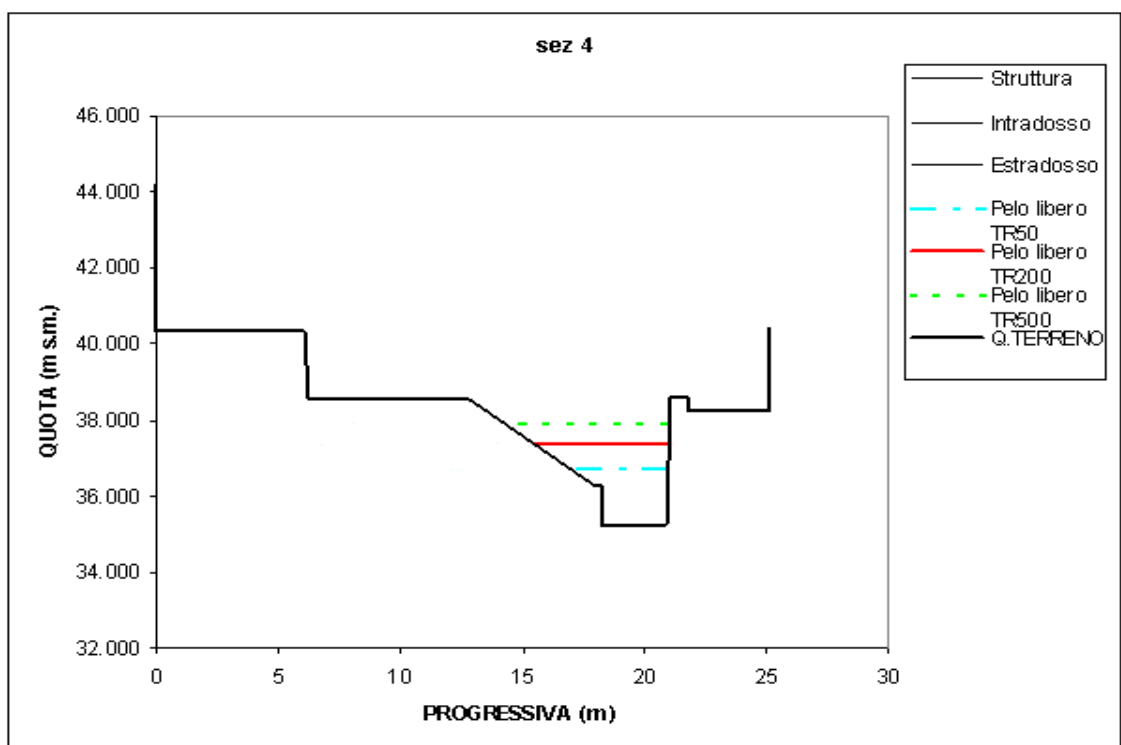
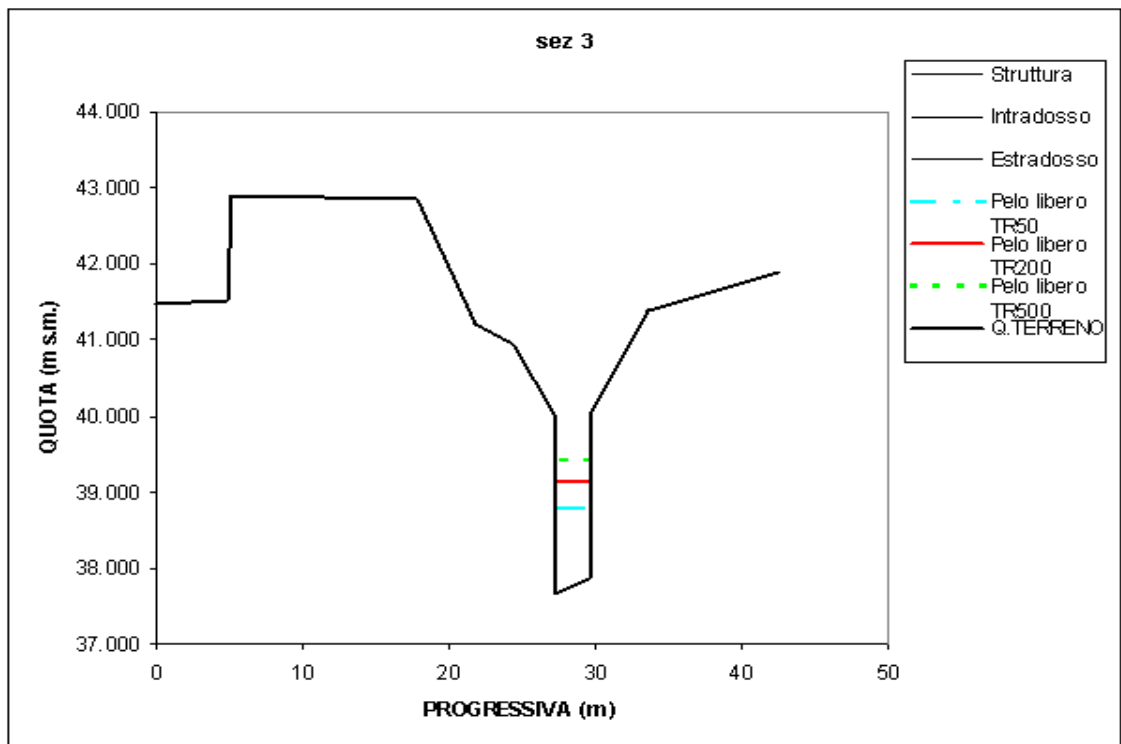

sez 5

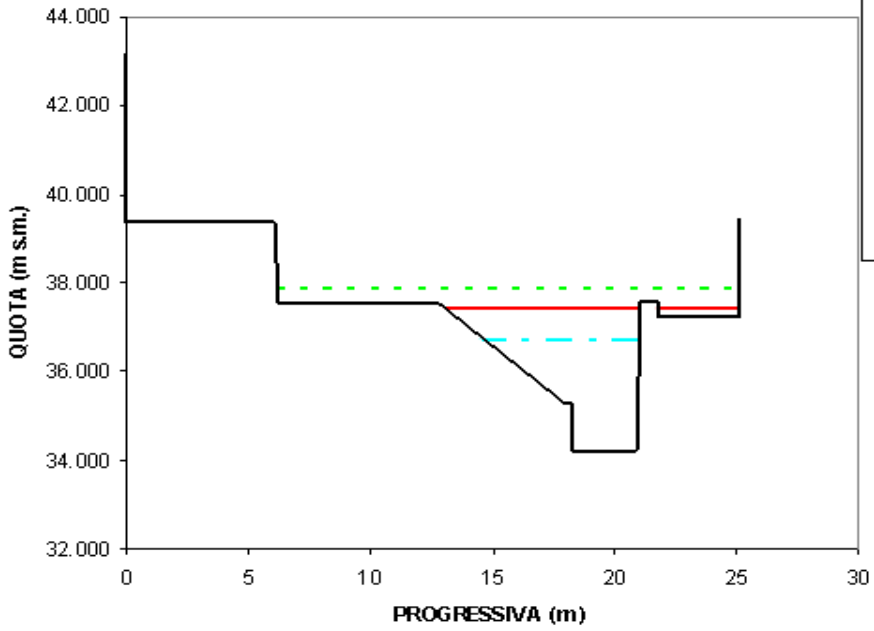

RIO CASELLO – PROFILO DI CORRENTE PER T=50 ANNI							
ID Sez.	Progr. (m)	Quota fondo (m s.m.)	P.L. (m s.m.)	A (m ²)	b (m)	v (m/s)	Fr (-)
1	0.00	59.29	59.92	1.45	3.10	5.53	2.58
2	75.19	38.66	39.70	7.60	16.85	1.05	0.50
3	175.24	37.68	38.78	2.42	2.42	3.30	1.05
4	209.79	35.20	36.70	4.25	3.96	1.88	0.58
5	239.79	34.00	36.70	9.60	6.25	0.83	0.21

Rio Casello - Risultati delle simulazioni idrauliche – T = 50 anni

RIO CASELLO – PROFILO DI CORRENTE PER T=200 ANNI							
ID Sez.	Progr. (m)	Quota fondo (m s.m.)	P.L. (m s.m.)	A (m ²)	b (m)	v (m/s)	Fr (-)
1	0.00	59.29	60.04	1.82	3.31	6.04	2.60
2	75.19	38.66	39.84	10.10	17.16	1.09	0.45
3	175.24	37.68	39.14	3.29	2.45	3.35	0.92
4	209.79	35.20	37.40	7.58	5.56	1.45	0.40
5	239.79	34.00	37.40	14.86	11.19	0.74	0.21

Rio Casello -Risultati delle simulazioni idrauliche – T = 200 anni

RIO CASELLO – PROFILO DI CORRENTE PER T=500 ANNI							
ID Sez.	Progr. (m)	Quota fondo (m s.m.)	P.L. (m s.m.)	A (m ²)	b (m)	v (m/s)	Fr (-)
1	0.00	59.29	60.11	2.05	3.44	6.34	2.62
2	75.19	38.66	39.96	12.13	17.35	1.07	0.41
3	175.24	37.68	39.41	3.95	2.47	3.29	0.83
4	209.79	35.20	37.90	10.64	6.70	1.22	0.31
5	239.79	34.00	37.90	23.11	18.96	0.56	0.16

Rio Casello -Risultati delle simulazioni idrauliche – T = 500 anni

RIO SLIGE – affluente del T. Maremola in loc. Isallo

dalla SEZ. **1** (quota 308 m slm circa)
alla SEZ. **5** (confluenza nel T. Maremola)

- PROFILI DI RIGURGITO IN CONDIZIONI DI MOTO PERMANENTE PER LE PORTATE $T = 50, 200, 500$ ANNI

- GEOMETRIA DELLE SEZIONI ED ALTEZZA DEL PELO LIBERO IN CONDIZIONI DI MOTO PERMANENTE PER LE PORTATE $T = 50, 200, 500$ ANNI

- MODELLAZIONE IDRAULICA IN CONDIZIONI DI MOTO PERMANENTE:
TABELLE DELLE GRANDEZZE IDRAULICHE
SIGNIFICATIVE PER LE PORTATE $T = 50, 200, 500$ ANNI

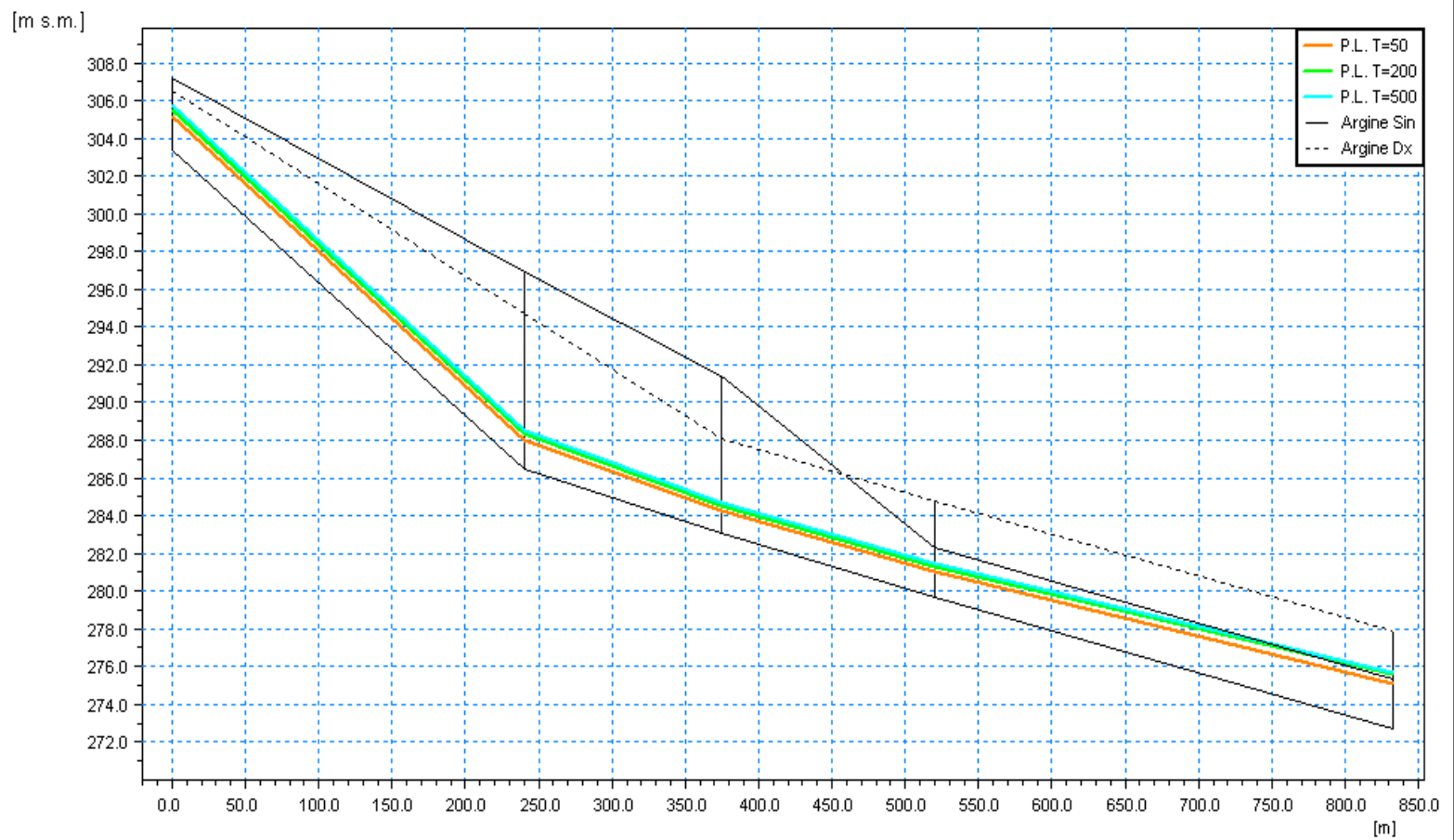

Progressiva	0.000	239.840	374.220	520.110	832.640
ID Sezione	1	2	3	4	5

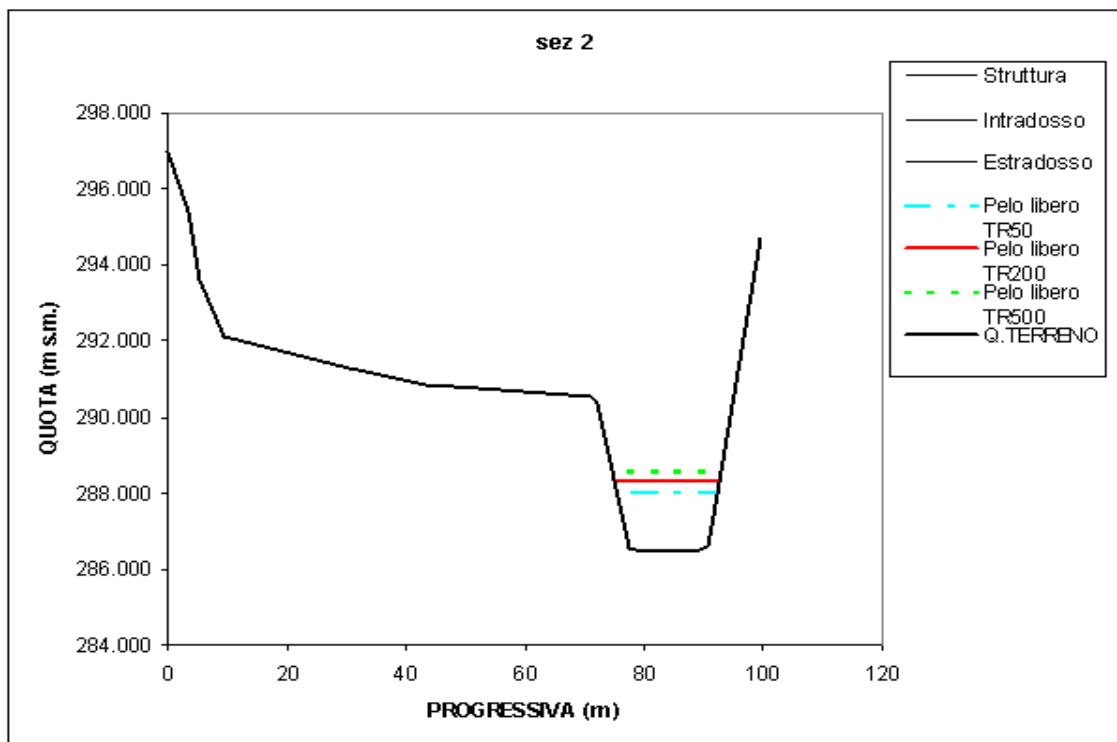
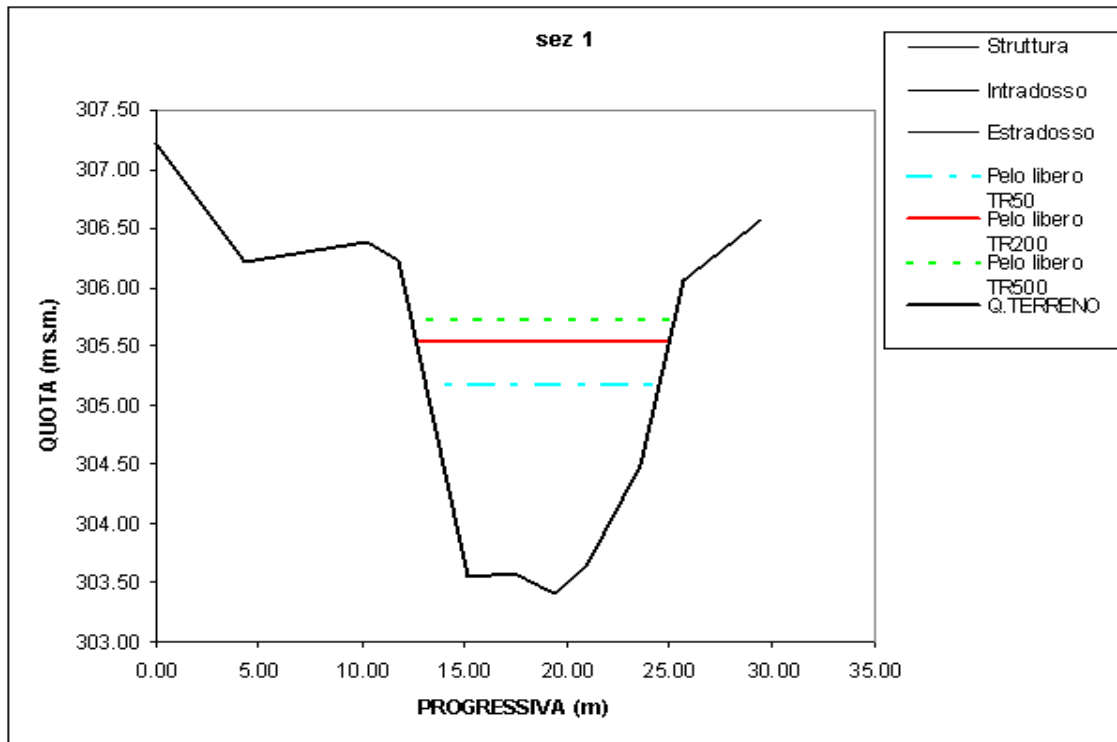

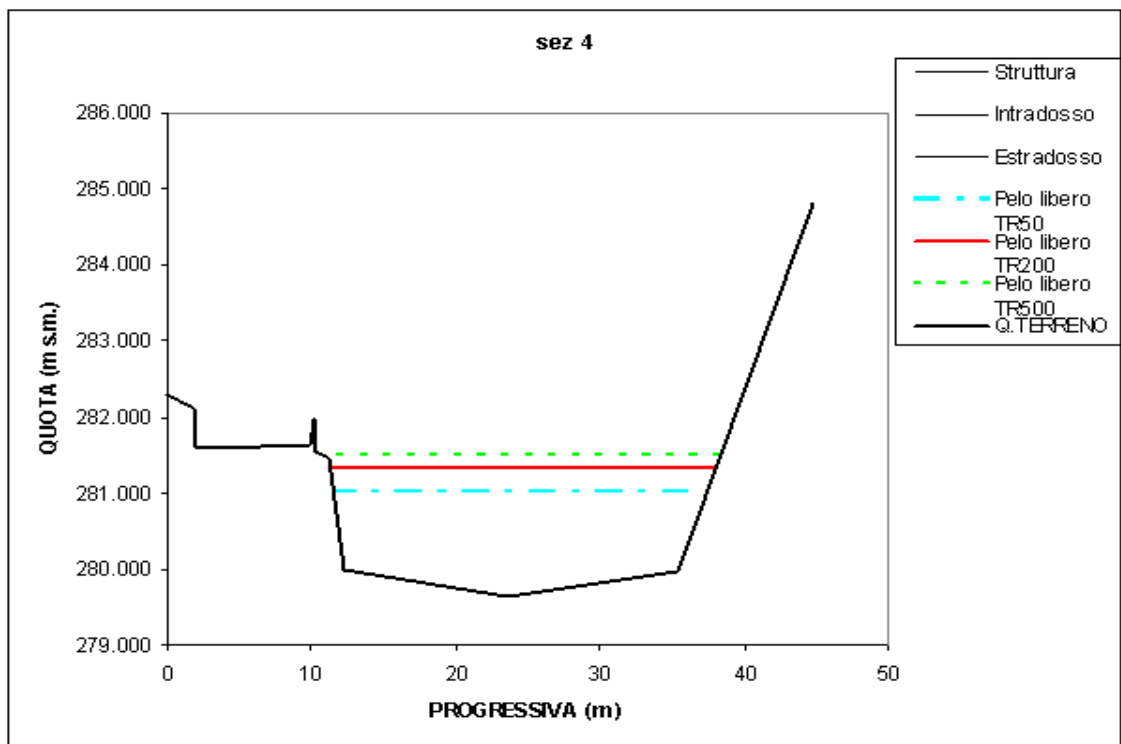
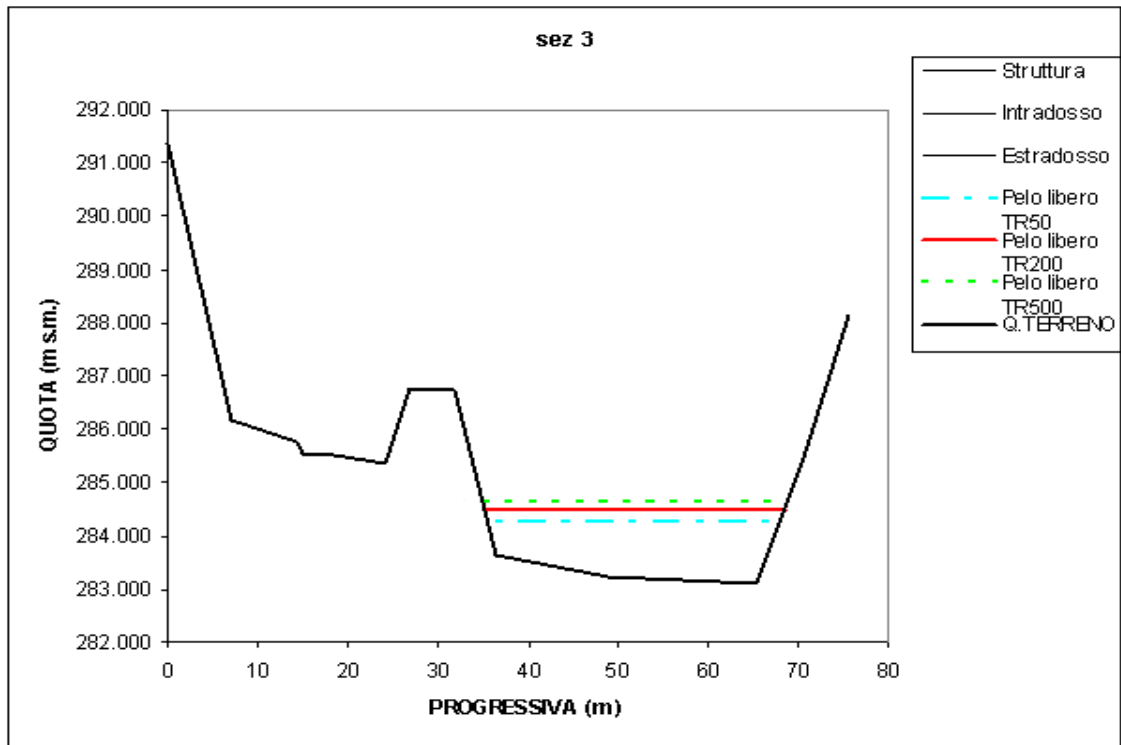

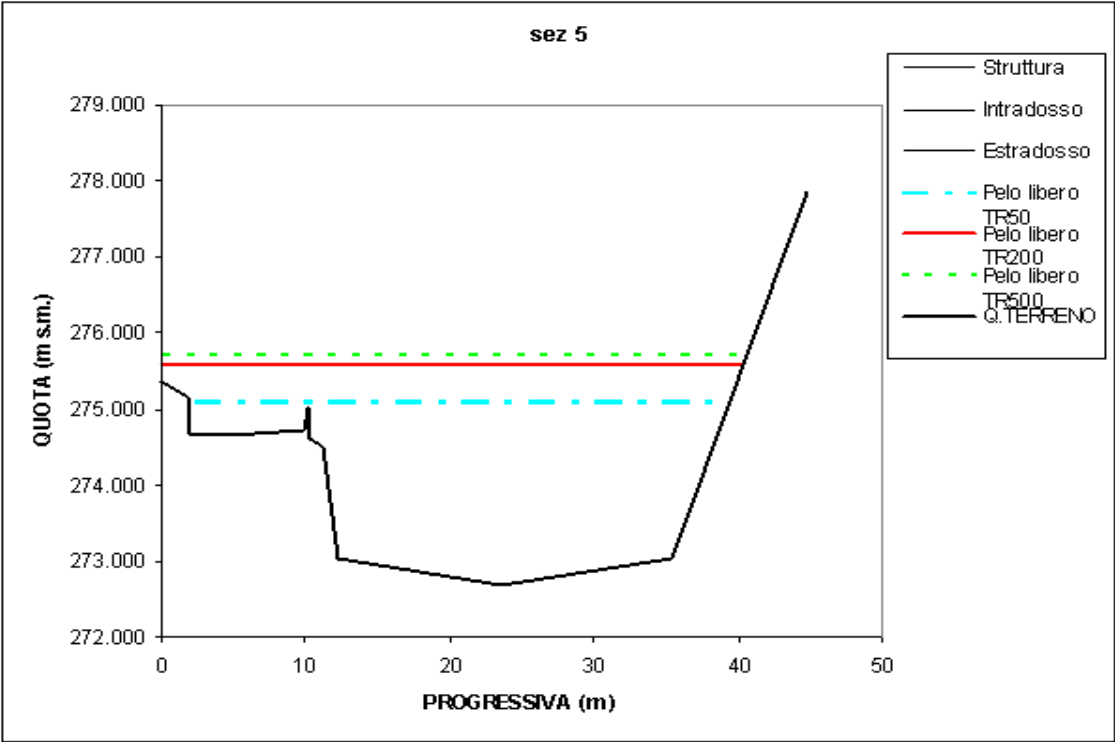

RIO SLIGE – PROFILO DI CORRENTE PER T=50 ANNI							
ID Sez.	Progr. (m)	Quota fondo (m s.m.)	P.L. (m s.m.)	A (m ²)	b (m)	v (m/s)	Fr (-)
1	0.00	303.41	305.17	14.32	11.36	7.40	2.11
2	239.84	286.46	287.98	22.13	16.73	4.79	1.33
3	374.22	283.09	284.25	30.19	32.52	3.51	1.16
4	520.11	279.64	281.01	29.05	25.84	3.65	1.10
5	832.64	272.70	275.08	60.19	37.58	1.76	0.44

Rio Slige - Risultati delle simulazioni idrauliche – T = 50 anni

RIO SLIGE – PROFILO DI CORRENTE PER T=200 ANNI							
ID Sez.	Progr. (m)	Quota fondo (m s.m.)	P.L. (m s.m.)	A (m ²)	b (m)	v (m/s)	Fr (-)
1	0.00	303.41	305.53	18.58	12.29	8.29	2.15
2	239.84	286.46	288.33	28.13	17.60	5.47	1.38
3	374.22	283.09	284.50	38.45	33.43	4.00	1.19
4	520.11	279.64	281.32	37.24	26.67	4.14	1.12
5	832.64	272.70	275.56	79.00	40.30	1.95	0.44

Rio Slige -Risultati delle simulazioni idrauliche – T = 200 anni

RIO SLIGE – PROFILO DI CORRENTE PER T=500 ANNI							
ID Sez.	Progr. (m)	Quota fondo (m s.m.)	P.L. (m s.m.)	A (m ²)	b (m)	v (m/s)	Fr (-)
1	0.00	303.41	305.73	21.06	12.81	8.74	2.17
2	239.84	286.46	288.52	31.59	18.08	5.82	1.41
3	374.22	283.09	284.65	43.22	33.94	4.26	1.20
4	520.11	279.64	281.50	41.96	27.55	4.39	1.13
5	832.64	272.70	275.71	85.06	40.59	2.16	0.48

Rio Slige -Risultati delle simulazioni idrauliche – T = 500 anni